

PRP

AVONDALE DRIVE HAYES

DESIGN AND ACCESS STATEMENT

(RESERVED MATTERS APPLICATION)



prp-co.uk

Architecture
Urban Design
Masterplanning
Landscape
Development Consultancy
Research



Client

Hillingdon Council
Civic Centre
High Street
Uxbridge
UB8 1UW

Client (developer)

Higgins Partnerships 1961 PLC
One Langston Road, Loughton,
Essex
IG10 3SD

Architects

PRP
10 Lindsey Street,
London
EC1A 9HP

Planning Consultants

Lichfields
The Minster Building
21 Mincing Lane
London
EC3R 7AG



Landscape Architects

Liz Lake Associates
1, The Exchange, 9 Station Rd,
Stansted Mountfitchet, Essex
CM24 8BE

Fire Consultant

Introba
150 Holborn
London
EC1N 2NS

M & E Consultants

Watkins Payne
3rd Floor, 25-27 Oxford Street,
London W1D 2DP

Structural and Civil Engineers

Iesis Structures
20 Ironmonger Lane
London
EC2V 8EPS

PRP Job Reference

BA9794

Issuing Date / Office

December 2025 / London

Revision Number / Date Checked

P2/27-02-26

Project Lead

Yiling Wang

REVISION P2

Note that this Design & Access Statement has been updated to address comments received from LBH during the determination period. It has been updated in full to provide a singular reference document for the latest proposed design. These updates include:

- The architectural expression of the tops of all blocks (Block B, C, D, E and F)
- The architectural expression of the phase 1b duplexes
- Further clarification of proposed materiality
- Internal layout of the corner 3B flats on level 1 in Blocks B & D and the Block D east elevation

Pages with updated content since the last revision include: 07, 21, 28, 78, 80, 81, 85, 86, 87, 89, 90, 91, 92, 93, 94, 95, 97, 99, 100

CONTENTS

1. EXECUTIVE SUMMARY

1.1	INTRODUCTION	6
1.2	THE BRIEF	7

2. OUTLINE PLANNING PERMISSION

2.1	INTRODUCTION	9
2.2	PARAMETER PLANS	10
2.3	DESIGN CODE	11
2.4	OUTLINE CONDITIONS	12

3. DESIGN EVOLUTION & STAKEHOLDER ENGAGEMENT

3.1	CONSULTATION TIMELINE	14
3.2	PRE-APPLICATION CONSULTATION	15
3.2.1	London Borough of Hillingdon - 29th August 2025	15
3.2.2	London Borough of Hillingdon - 24th October 2025	16
3.2.3	Final follow-up response to LBH	17
3.3	PUBLIC CONSULTATION AND FEEDBACK	18

4. THE RESERVED MATTERS

4.1	INTRODUCTION	21
4.2	PROPOSED DEVELOPMENT EXTENTS	22
4.3	PROPOSED MASSING	23
4.3.1	Storey Heights	23
4.3.2	Compliance with Outline requirements	24
4.4	PHASING	25
4.5	HOUSING QUANTUM AND MIX	26
4.6	PHASE 2 - GROUND FLOOR PLAN	27
4.7	PHASE 2 - FIRST FLOOR PLAN	28
4.8	PHASE 2 GROUND FLOOR STRATEGIES	29
4.8.1	Active Frontages	29
4.8.2	Lobbies and Postal Strategy	29
4.8.3	Refuse Strategy	30

4.8.4	Fire and Access Strategy	30
4.8.5	Parking and Access Strategy	31
4.8.6	Cycle Strategy	31
4.9	PHASE 1B - GROUND FLOOR PLAN	32
4.10	PHASE 1B - FIRST FLOOR PLAN	33
4.11	PHASE 1B GROUND FLOOR STRATEGIES	34
4.11.1	Active Frontages	34
4.11.2	Lobbies and Postal Strategy	34
4.11.3	Refuse Strategy	35
4.11.4	Fire and Access Strategy	35
4.11.5	Parking and Access Strategy	36
4.11.6	Cycle Strategy	36
4.12	SITE WIDE STRATEGIES	37
4.12.1	Site Levels Strategy	37
4.12.2	Secured By Design	38
4.13	PHASE 2 - TYPICAL FLOOR PLAN	39
4.14	PHASE 1B - TYPICAL FLOOR PLAN	40
4.15	SITE WIDE UPPER FLOOR STRATEGIES	41
4.15.1	Daylight, privacy and overlooking strategy	41
4.15.2	Dual Aspect	42
4.16	PHASE 2 - ROOF PLAN	43
4.17	PHASE 1B - ROOF PLAN	44
4.18	TYPICAL LAYOUTS	45
4.18.1	4 Bed Duplex	45
4.18.2	3 Bed Duplex	46
4.18.3	2 Bed Duplex	47
4.18.4	3 Bed Flat	48
4.18.5	3 Bed Flat Alternative	49
4.18.6	1 and 2 Bed Flats	50
4.19	INCLUSIVE DESIGN	51
4.19.1	Inclusive design principles	51
4.19.2	Accessible flat layouts	52
4.20	PRIVATE AMENITY AND DEFENSIBLE SPACE	53
4.20.1	Site-wide strategy	53
4.20.2	View into landscaped park connection from amenity	54

5. LANDSCAPE

5.1	LANDSCAPE STRATEGY	56
5.1.1	Landscape Masterplan	56
5.1.2	Play Strategy	57
5.2	PUBLIC REALM DESIGN	58
5.2.1	Street Frontages	58
5.2.2	Hitherbroom Link	59
5.2.3	Communal Gardens - Phase 2	61
5.2.4	Communal Garden - Phase 1B	62
5.3	PLANTING STRATEGY	63
5.3.1	Retained & Removed Trees	63
5.3.2	Tree Planting Strategy	64
5.3.3	Key Tree Species	65
5.3.4	Climate Resilience	66
5.3.5	General Planting Strategy	67
5.3.6	Green & Brown Roofs	68
5.4	LANDSCAPE MATERIAL STRATEGY	69
5.4.1	Surfacing Strategy	69
5.4.2	Boundary Treatment Strategy	70
5.4.3	External Furniture Strategy	71

6. ARCHITECTURAL EXPRESSION

6.1	CONTEXT STUDIES	73
6.1.1	Surrounding Context	73
6.1.2	Material & Architectural detailing study	74
6.1.3	Avondale Drive Phase 1A	75
6.2	ELEVATIONAL CONCEPT	76
6.2.1	Summary from Outline Stage	76
6.2.2	Refined concept for RMA proposal	77
6.3	MATERIALITY AND COLOUR PALETTE	78
6.4	CHARACTER AREAS	79
6.4.1	Character areas, marker building and elevational hierarchy strategies	79
6.4.2	Avondale Drive	80
6.4.3	Abbotswood Way	80
6.4.4	Hitherbroom Link	81

CONTENTS

6.4.5 Park Edge	81
6.4.6 Courtyard	82
6.5 FENESTRATION	83
6.5.1 Window Types	83
6.5.2 Window Spacings	84
6.6 ELEVATIONAL DETAIL ELEMENTS	85
6.6.1 Rainwater pipes and balcony drainage	85
6.7 ARCHITECTURAL DETAILS	86
6.7.1 Corner expression	86
6.7.2 Marker Building	87
6.7.3 Phase 2 Duplexes	88
6.7.4 Block B/D Entrances	89
6.8 PROPOSED BAY STUDIES	90
6.8.1 Duplexes	90
6.8.2 Block D Entrance	91
6.8.3 Block F Entrance	92
6.8.4 Blocks E and F	93
6.9 PROPOSED SITE ELEVATIONS	94
6.9.1 South Elevation	94
6.9.2 North Elevation	95
6.10 ILLUSTRATIVE VIEWS AND CGIS	96
6.10.1 View East along Avondale Drive	96
6.10.2 View South along Abbotswood Way	98
6.10.3 Block D Entrance	100
7. TECHNICAL CONSIDERATIONS	
7.1 MEP, ENERGY & SUSTAINABILITY STRATEGY	102
7.2 TRANSPORT STRATEGY	104
7.3 WASTE STRATEGY	105
7.4 FIRE STRATEGY	105
7.5 STRUCTURAL STRATEGY	106
7.6 DRAINAGE STRATEGY	107
7.7 ACCESS, CLEANING AND MAINTENANCE	108
7.8 WINDOW CLEANING STRATEGY	109

7.9 DAYLIGHT SUNLIGHT STRATEGY	110
7.10 OVERHEATING STRATEGY	111
7.11 WIND TESTING	113

8. APPENDIX

8.1 APPENDIX 1 - DETAILED AREA SCHEDULE	115
8.1.1 Phase 2	115
8.1.2 Phase 1B	116
8.1.3 Summary	117
8.2 APPENDIX 2 - MANDATORY CODE COMPLIANCE SCHEDULE	118





1. EXECUTIVE SUMMARY

1.1 INTRODUCTION

This Design and Access Statement has been prepared by PRP on behalf of London Borough of Hillingdon in collaboration with its development partner Higgins 1961 PLC, for the reserved matters application for the redevelopment of Avondale Drive Estate UB3 3NR.

It sets out the details of the matters reserved by Condition 1 of the outline permission comprising:

- (a) 'Appearance' – the aspects within the development which determine the visual impression that the buildings/ place makes, including the external built form of the development, its architecture, materials, decoration, lighting, colour and texture.
- (b) 'Means of Access' – the accessibility to and within the site, for vehicles, cycles and pedestrians in terms of the positioning and treatment of access and circulation routes and how these fit into the surrounding access network.
- (c) 'Landscaping' – the treatment of land (other than buildings) for the purpose of enhancing or protecting the amenities of the site and the area in which it is situated.
- (d) 'Layout' – the way in which buildings, routes and open spaces within the development are provided, situated and orientated in relation to each other and to buildings and spaces outside the development.
- (e) 'Scale' – the height, width and length of each building proposed within the development in relation to its surroundings.

The DAS also demonstrates how the proposed reserved matters comply with planning conditions attached to the outline permission (as amended) including:

- the parameter plans listed under condition 3
- the maximum quantum of development defined in condition 5
- the housing mix defined in condition 6
- the phasing plan approved under condition 7
- the Design Code submitted pursuant to condition 8
- the residential density defined in condition 9
- the maximum building heights defined in condition 10
- the requirements for accessible housing set out in condition 14
- details of the landscaping scheme required by condition 15
- the requirements in relation to the retention of trees, hedges and shrubs set out in condition 16



SKETCH VIEW LOOKING NORTH TOWARDS HITHERBROOM PARK

1.2 THE BRIEF

KEY OBJECTIVES

The London Borough of Hillingdon (LBH), in collaboration with its development partner, Higgins, commissioned the design team to develop the Reserved Matters Application (RMA) for Phases 1B and 2 of the Avondale Drive Estate redevelopment. The brief sought a comprehensive design that would fully unlock the potential of the remaining site, providing a significant quantum of affordable housing, a sensitively contextualised elevational treatment, and an enhanced public realm.

The key objectives outlined for the designers were:

- To deliver a development with massing and density that respects and is sensitively integrated with the site's surrounding context.
- To prioritise placemaking and connectivity throughout the scheme.
- To create a robust development with simple yet high-quality construction detailing that ensures longevity.
- To maximise the provision of affordable housing.
- To design all homes as tenure-blind, eliminating any architectural hierarchy between affordable and private units.
- To minimise the impact of vehicular access on the site and its surroundings.

The design team has consistently reviewed the proposed scheme against these core objectives, ensuring that the final proposal comprehensively addresses and fulfils the requirements of the brief.



VIEW EAST ALONG AVONDALE DRIVE



2. OUTLINE PLANNING PERMISSION

2.1 INTRODUCTION

SITE PLANNING HISTORY

On 28 September 2022 Hybrid Planning Application (ref: 76551/APP/2021/4502) (hereafter “the original application” or “the 2022 hybrid permission”) was granted by London Borough of Hillingdon for full planning permission for an initial first phase of development on the Site (Phase 1 a) and two subsequent outline phases (Phase 1b and Phase 2).

On 13 November 2025 a s73 application (ref. 76551/APP/2025/2861) was submitted to the London Borough of Hillingdon to vary the wording of a number of planning conditions attached to the original permission including conditions 3 (parameter plans), 4 (approved documents), 5 (land use/quantum), 6 (housing mix), 7 (phasing plan), 8 (design code), 9 (density), 10 (building heights) and 15 (landscaping scheme).

Once approved, the s73 application will result in a new planning permission allowing for up to 266 homes to be built in the outline area, across phases 1b and 2. The s73 application has now been validated and will need to be granted permission prior to the final approval of this Reserved Matters Application (which is drafted in response to those revised conditions). Please see the Planning Compliance Report prepared by Lichfields for further details.

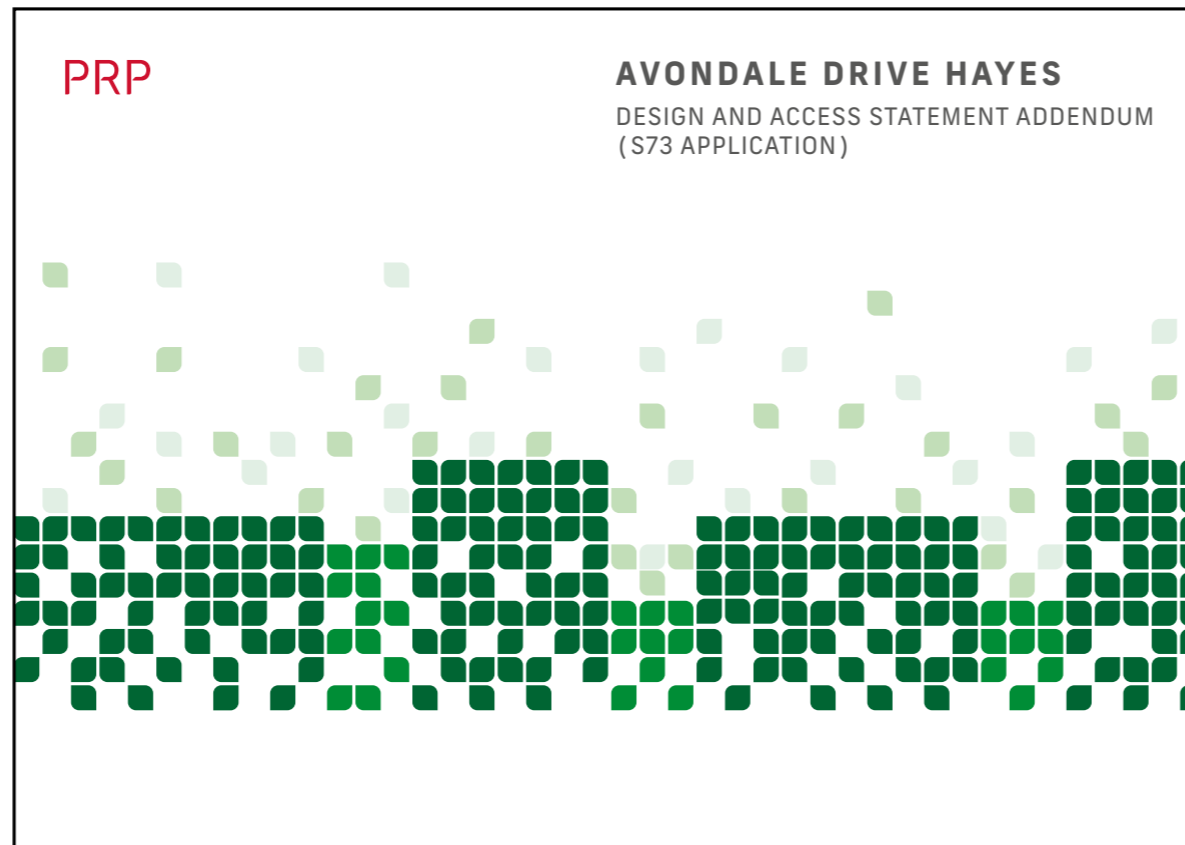

ORIGINAL APPLICATION - HYBRID PLANNING APPLICATION (REF: 76551/APP/2021/4502)

Design and Access Statement prepared by Pollard Thomas Edwards Architects



S73 APPLICATION (REF. 76551/APP/2025/2861)

Design and Access Statement Addendum prepared by PRP Architects

2.2 PARAMETER PLANS

PARAMETER PLANS

The detailed design has been prepared in strict accordance with the parameters set out in the Outline Planning Permission (as amended). Those parameter plans establish the framework for the Avondale Drive Estate redevelopment, defining development zones, building heights, massing and access arrangements.

This Design and Access Statement demonstrates how the proposals for Phase 1B and 2 both comply with these parameters (and other controls) whilst delivering a high quality residential development. From overall massing to the finer details of architectural expression, the design has been rigorously tested against the parameter plans to ensure full compliance and a coherent relationship with the wider masterplan vision.

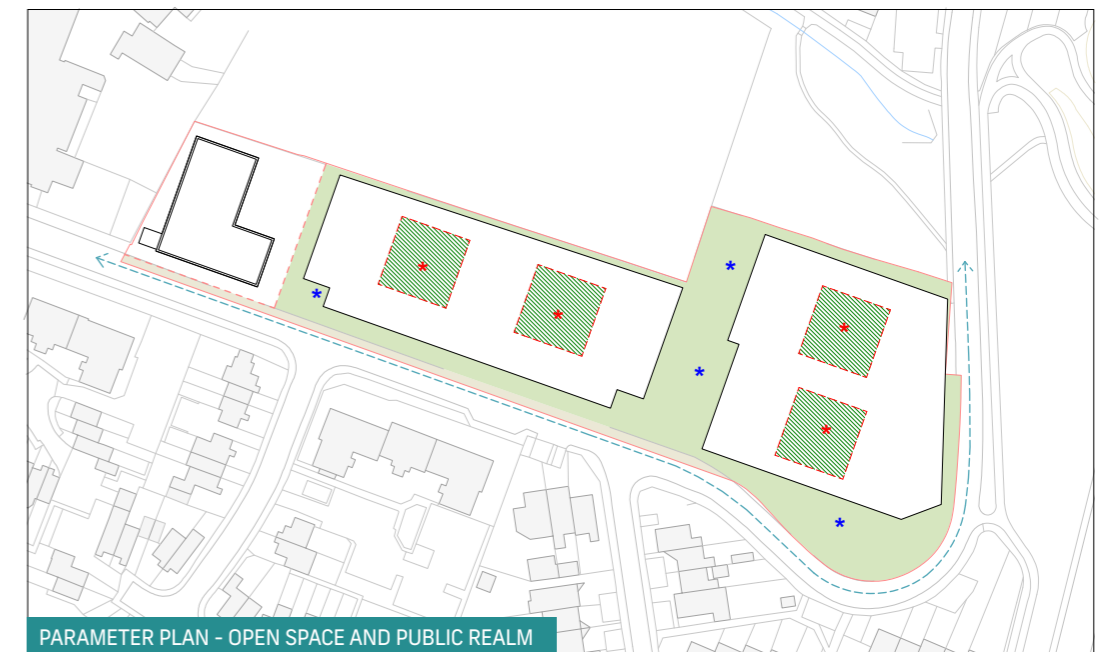
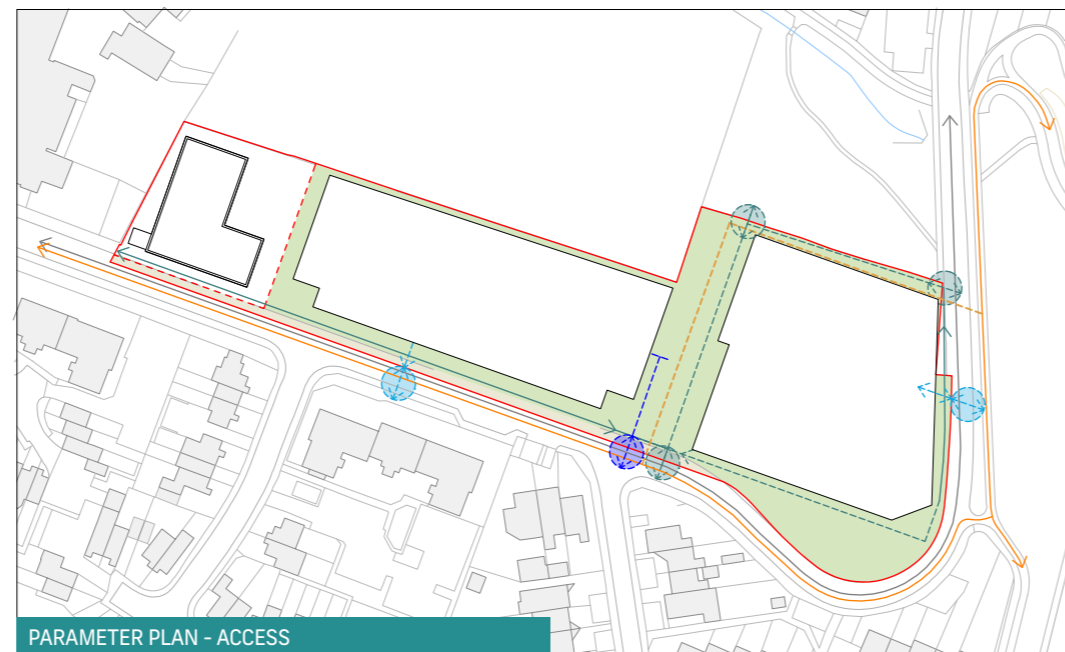
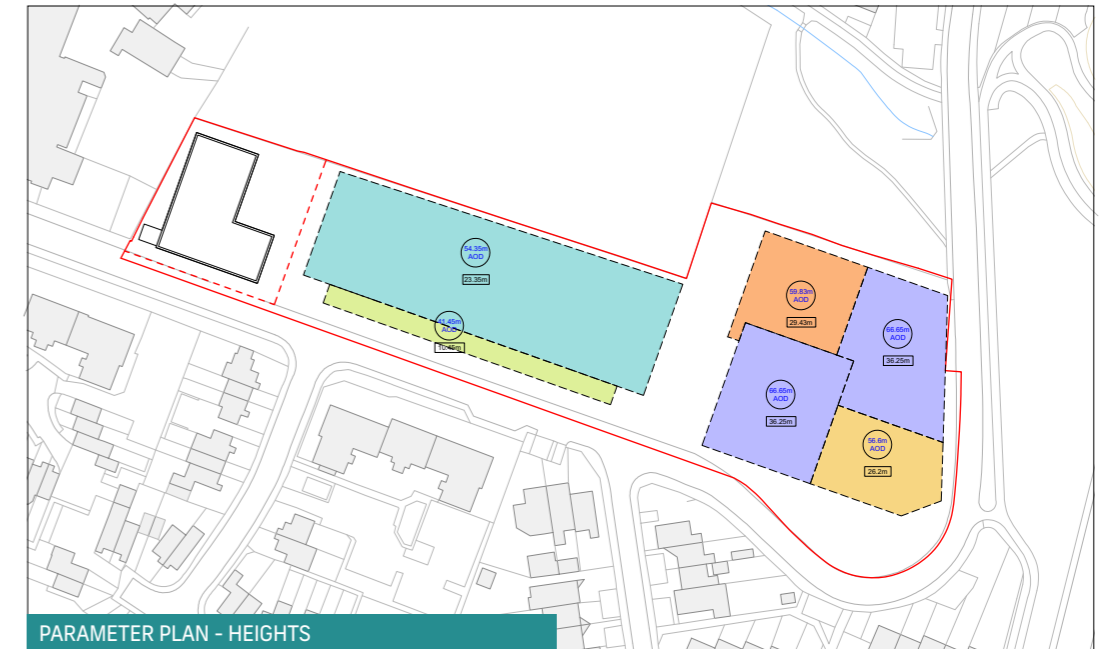
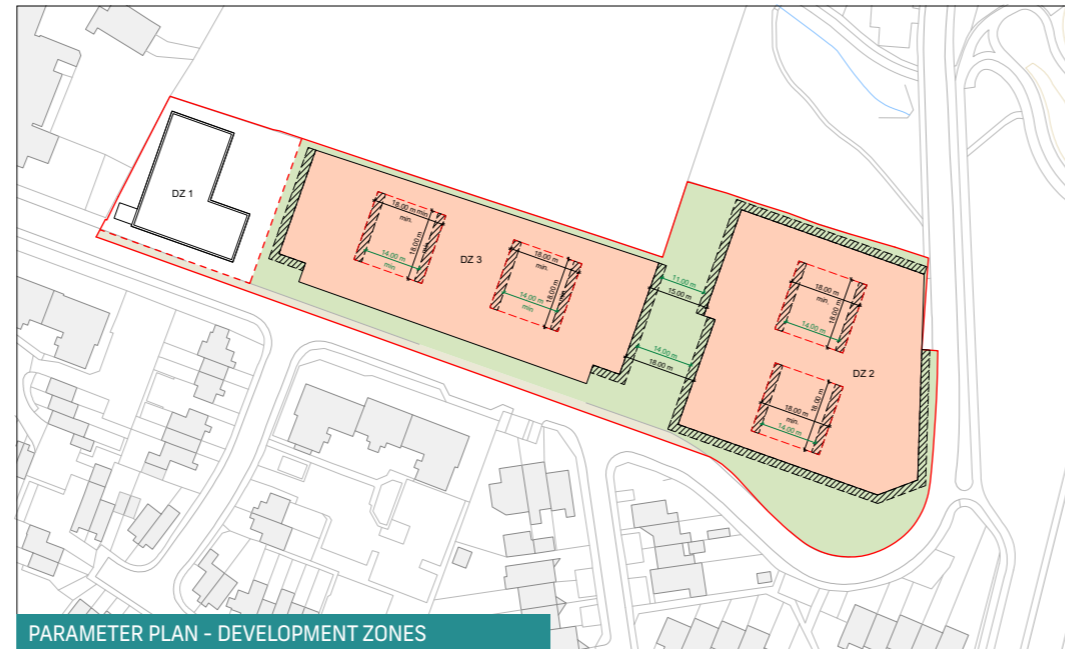

2.3 DESIGN CODE

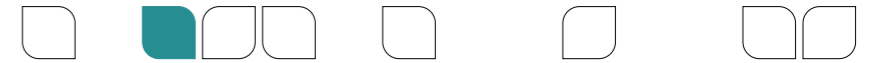

DESIGN CODE

A detailed Design Code has been submitted pursuant to Condition 8 of the hybrid planning permission. The Code is a controlling document against which subsequent Reserved Matters submissions must demonstrate compliance and comprises Mandatory and Advisory elements designed to secure and maximise design quality.

This Design and Access Statement explains how the proposals for Phase 1B and 2 comply with all Mandatory requirements and the majority of Advisory recommendations in the Design Code. The detailed design builds on and refines the vision set out in the Outline Permission and Design Code, delivering a high-quality public realm and well-designed homes, and employing varied architectural detailing that responds to and celebrates the local character.

Mandatory code
All mandatory codes **must be followed** in developing the design.

Advisory code
Advisory codes reflect best practice and good design principles **should be considered** in developing the design.

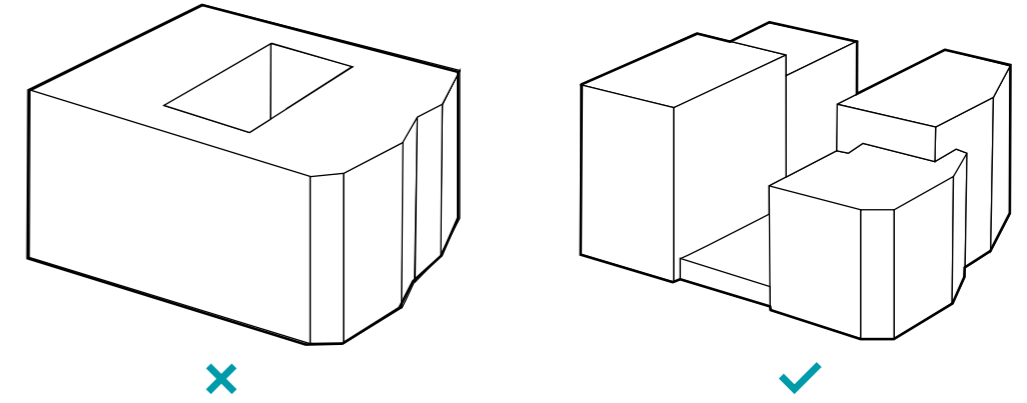

RECORDING COMPLIANCE

Throughout this document, evidence of compliance with the Design Code will be recorded through use of the tags below indicating which aspect of the code is evidenced, as follows:

A / 000 Evidence of consideration of the Advisory code, reference number as stated

M / 000 Evidence of compliance with the Mandatory code, reference number as stated

In addition to this, a full schedule of compliance with the Mandatory code can be found in Appendix B under chapter 8 of this document.

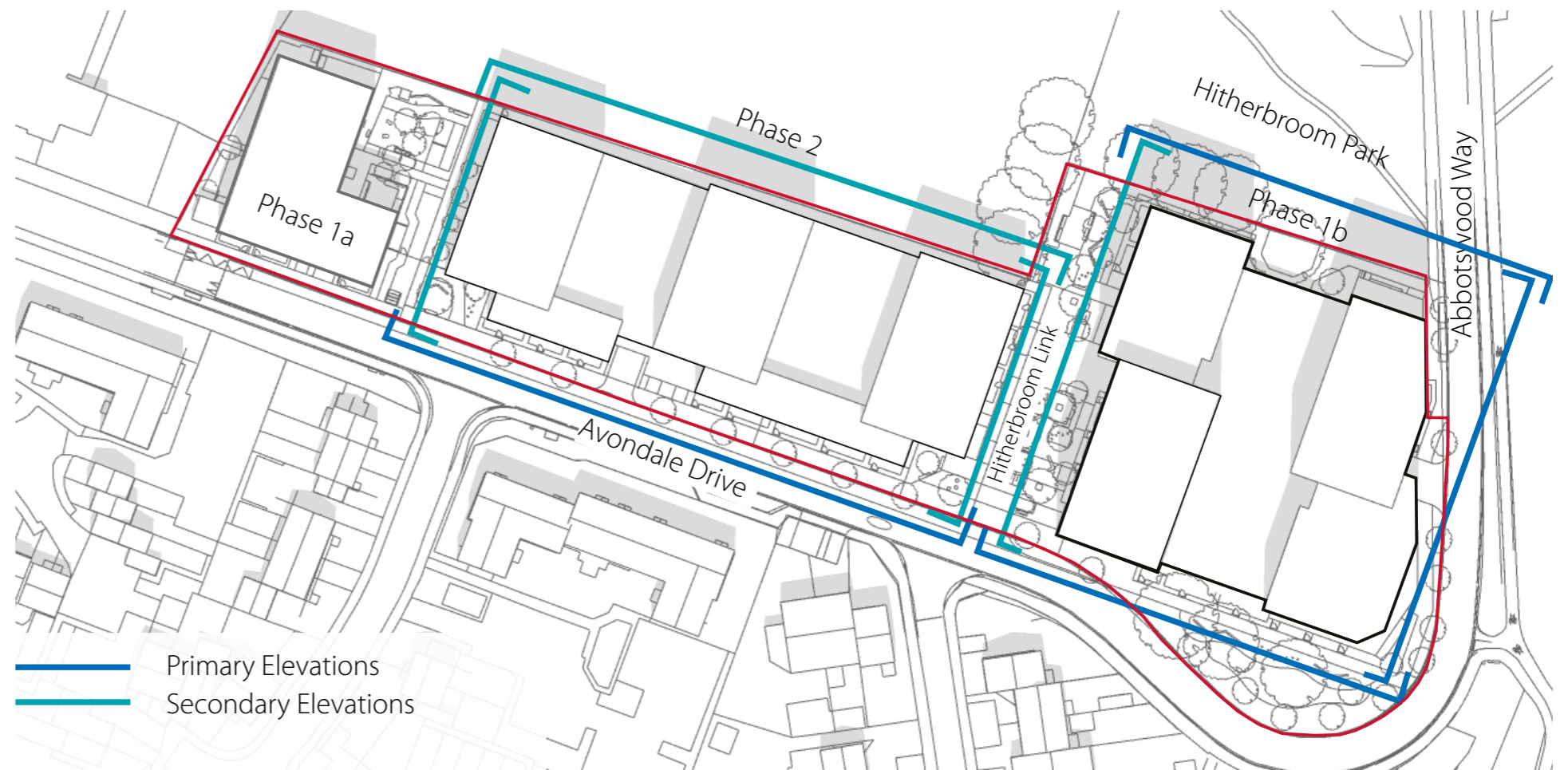

EXTRACTS FROM DESIGN CODE

2.4 OUTLINE CONDITIONS

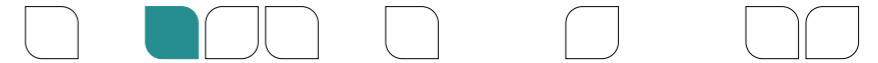

OUTLINE CONDITIONS

The Outline Planning Permission is subject to a number of conditions, with relevant design related conditions listed below. The table to the right gives details as to where the information demonstrating how this RMA submission complies with each condition can be found within the application.

Condition 1, comprising:

(a) 'Appearance' – the aspects within the development which determine the visual impression that the buildings/ place makes, including the external built form of the development, its architecture, materials, decoration, lighting, colour and texture.

(b) 'Means of Access' – the accessibility to and within the site, for vehicles, cycles and pedestrians in terms of the positioning and treatment of access and circulation routes and how these fit into the surrounding access network.

(c) 'Landscaping' – the treatment of land (other than buildings) for the purpose of enhancing or protecting the amenities of the site and the area in which it is situated.

(d) 'Layout' – the way in which buildings, routes and open spaces within the development are provided, situated and orientated in relation to each other and to buildings and spaces outside the development.

(e) 'Scale' – the height, width and length of each building proposed within the development in relation to its surroundings.

Condition 3 - Parameter Plans

Condition 5 - Maximum quantum of development

Condition 6 - Housing mix

Condition 7 - Phasing plan

Condition 8 - Design Code

Condition 9 - Residential density

Condition 10 - Maximum building heights

Condition 14 - Accessible housing requirements

Condition 15 - Details of the landscaping scheme

Condition 16 - Requirements in relation to the retention of trees, hedges and shrubs

CONDITION	EVIDENCE OF RMA DESIGN COMPLIANCE / CONSIDERATION
1 - Appearance, Means of Access, Landscaping, Layout, Scale	Chapters 4, 5, 6 of this Design and Access Statement & Planning Drawings submitted as part of this Reserved Matters Application
3 - Parameter Plans	Parameter Plan 1 can found in section 4.2 Parameter Plan 2 can found in section 4.3 Parameter Plan 3 can found in section 4.8/4.11 Parameter Plan 4 can found in section 5.1
5 - Maximum quantum of development	Appendix 1/ Section 8.1 of Design and Access Statement
6 - Housing mix	Section 4.5 of Design and Access Statement
7 - Phasing plan	Section 4.4 of Design and Access Statement
8 - Design Code	Appendix 2 / Section 8.2 schedules evidence of compliance for all mandatory code, with detailed references to sections of this Design and Access Statement
9 - Residential density	Section 4.5 of Design and Access Statement
10 - Maximum building heights	Section 4.3 of Design and Access Statement
14 - Accessible housing requirements	Section 4.19 of Design and Access Statement
15 - Details of the landscaping scheme	Chapter 5 of Design and Access Statement
16 - Requirements in relation to the retention of trees, hedges and shrubs	Section 5.3 of Design and Access Statement

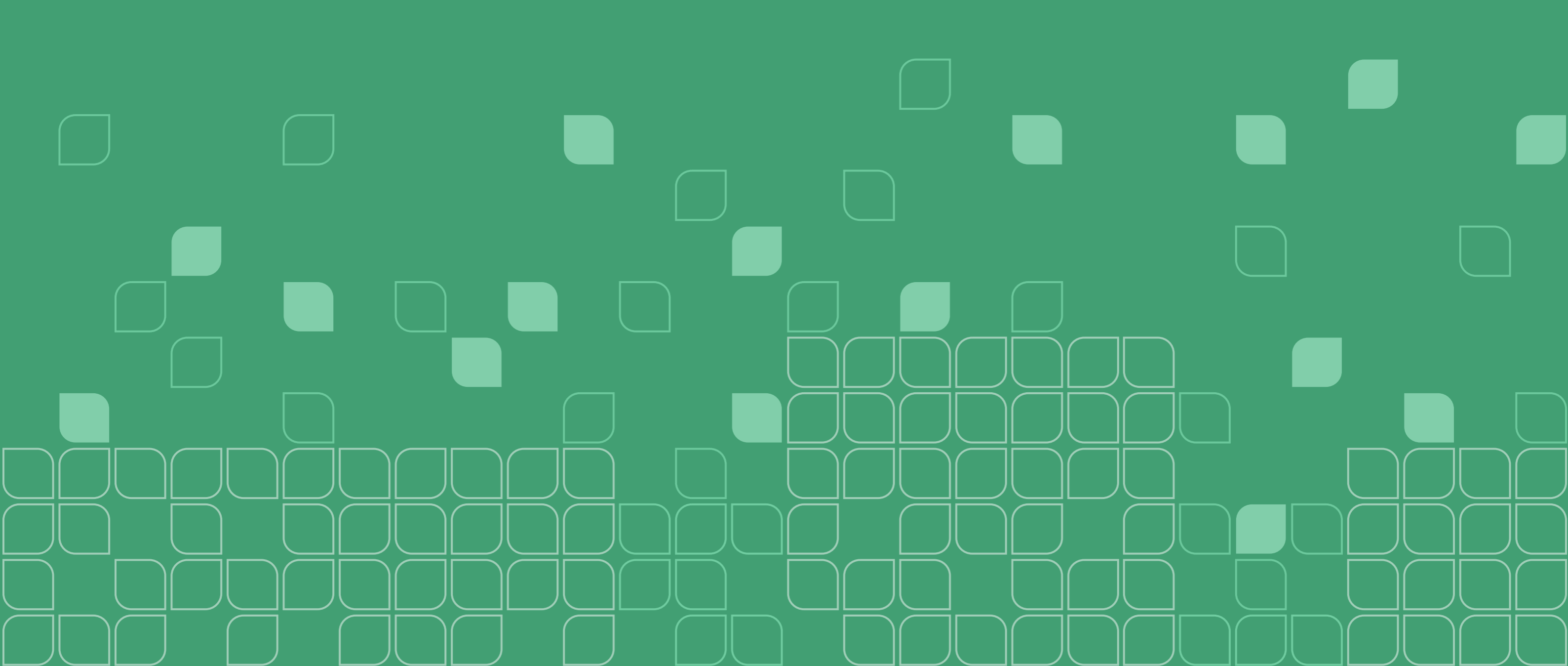

3. DESIGN EVOLUTION & STAKEHOLDER ENGAGEMENT

3.1 CONSULTATION TIMELINE

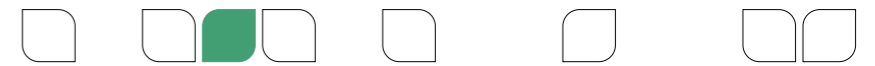

Extensive consultation with the LPA, GLA and the public has taken place in preparation for this Reserved Matters Application. This is illustrated in the timeline below, demonstrating a proactive and iterative design process that has incorporated valuable feedback from various stakeholders.

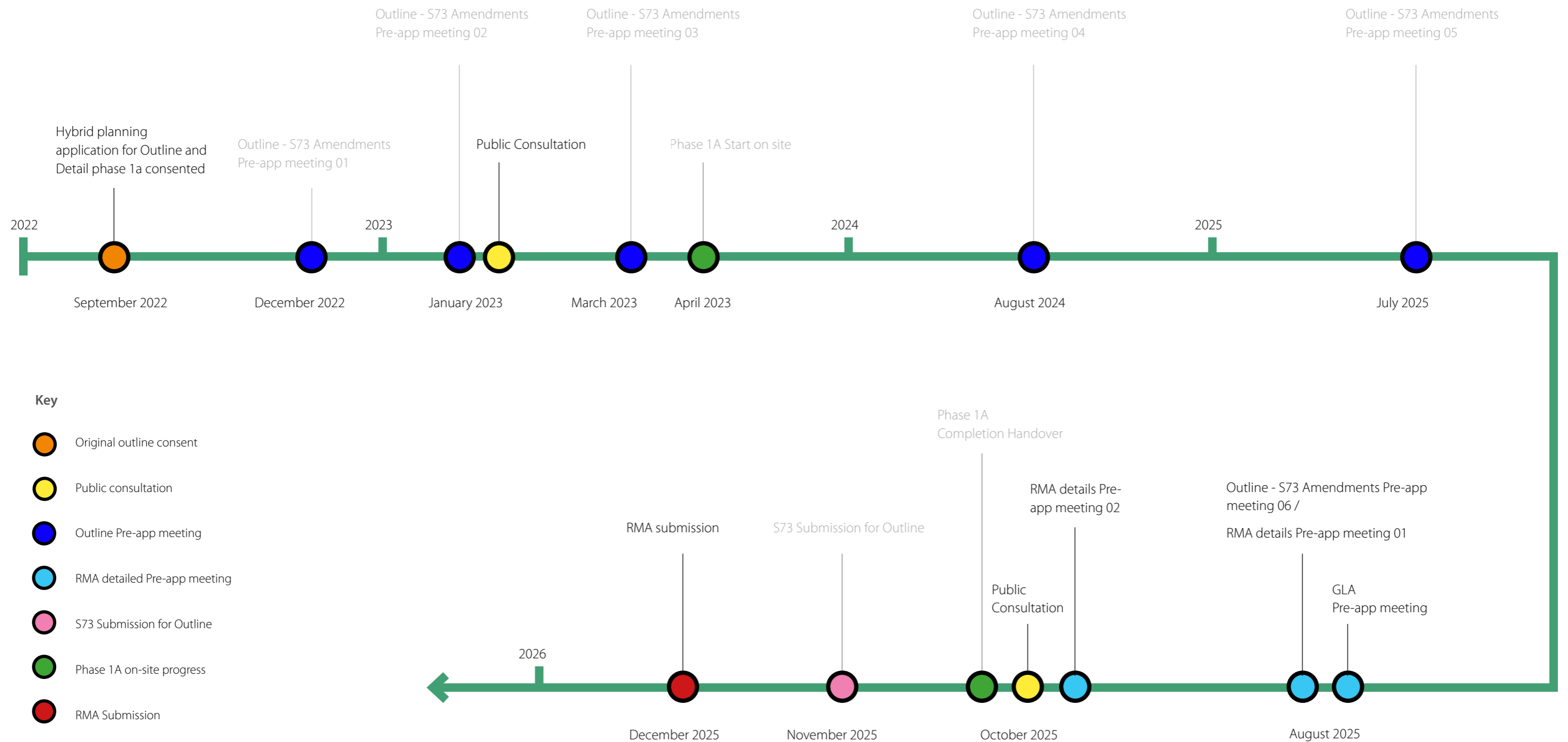

3.2 PRE-APPLICATION CONSULTATION

3.2.1 London Borough of Hillingdon - 29th August 2025



Based on the agreed Planning Performance agreements with LBH, two pre-application meetings were arranged with a particular focus on the RMA design. More detailed elevational approach, layouts and landscape design were presented at this pre-application meeting required by LBH.

At the Pre-Application meeting held on the 29th August 2025, the consultant team presented the final illustrative proposed scheme submitted under the S73 amendment to the outline application and presented RMA-level detailed information supporting that scheme for the first time.

Proposed detailed strategies for site levels, approach to inclusive design, drainage and all servicing/access diagrams were shown alongside initial elevation design testing which suggested a contextual approach and diagrammised the intended strategies.

SUMMARY OF FEEDBACK

Feedback received from LBH highlighted a need for more detail in the elevational design in particular:

"The design intent for building elevations must be clearly and comprehensively communicated with a supporting design rationale so we can proceed with a review. To properly evaluate the elevational treatments, we require:

- **The materiality:** (e.g., brick, metal cladding, glass) and how they support the design narrative.
- **Fenestration strategy:** Provide clarity on window/door size, rhythm, and treatment. Including reveal depths.
- **Colour palette:** Where the colours will be neutral, contrasting or have tonal harmony to adjacent buildings.
- **Balconies:** location of inset balconies and metal projected from the elevation to understand how these will impact the elevations, with the design intent for the railing and soffits.
- **Architectural features** and details: including canopies, cornices, parapets, screens, brise-soleil and coping details;
- **Rainwater goods:** Location of downpipes, hoppers, integrated or expressed"



GROUND FLOOR EXPRESSION

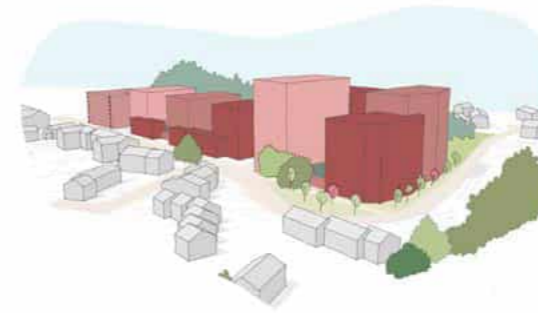
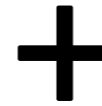

VOLUME EXPRESSION

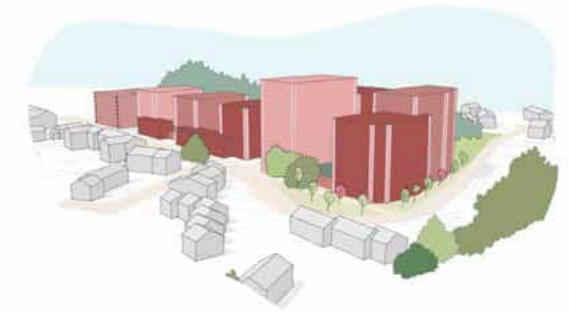
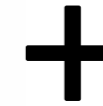

VERTICAL EXPRESSION

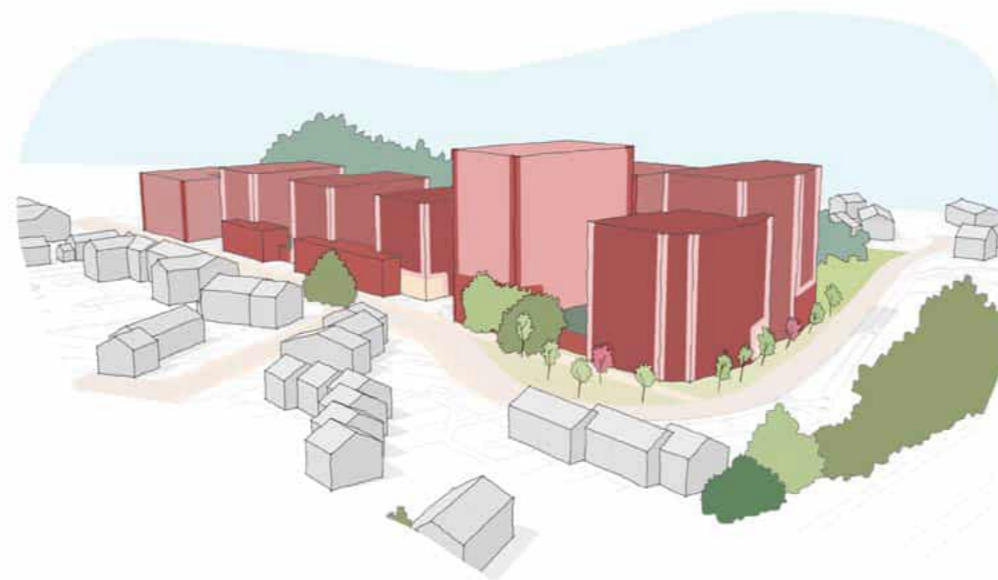

VIEW FROM SOUTH EAST



VIEW FROM NORTH WEST

PRESENTED DIAGRAMMATIC APPROACH TO ELEVATIONAL DESIGN

PRE-APPLICATION CONSULTATION

3.2.2 London Borough of Hillingdon - 24th October 2025

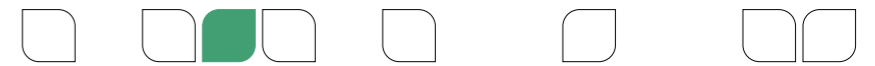

In response to the request for more elevational detail, a follow-up pre-application meeting was arranged with a particular focus on the proposed detailed elevational design.

Detailed proposed layouts and landscape design were also presented.

SUMMARY OF FEEDBACK

Whilst no formal written feedback has yet been issued, the following points were discussed in the meeting:

- Reiterated strong support for the massing, layouts and general approach to elevational detailing
- Proposed materiality accepted in principle with a request for brick samples to be shown later. Opportunities to use the same brick tones as phase 1A encouraged
- Precedents showing similar brick patterning to that proposed on the phase 2 duplex requested
- Additional detailing to the tops of the mid-scale blocks and duplex street elevations encouraged. It was accepted that the parapet heights could not be reduced due to safety benefits, but reducing the perception of the parapet height on the duplexes particularly was suggested
- Poor outlook to specific secondary windows on the side returns of the duplexes was raised. These have since been removed.



PRESENTED IMAGERY SHOWING COORDINATED ARCHITECTURAL DESIGN AS PROPOSED

PRE-APPLICATION CONSULTATION

3.2.3 Final follow-up response to LBH

Two final follow-up response packs were issued to LBH; one in mid-November and one in early December 2025, showing further testing and illustrating the final adjustments to the elevational design following comments made at the last pre-application meeting.

Notable changes in response to comments included:

- Additional detailing to the tops of blocks with a proposed alternating brick header pattern to all the mid-scale and taller blocks
- Additional brick work detailing added to the tops of the duplexes south elevation to reduce the perception of the brick parapet and emphasise each dwelling individually
- A change of brick tone to the chamfer of block E for a more homogeneous response meaning that the white brick is used for small-scale detailing only
- Explored potential for the proposed medium brick tone to match that of phase 1A, relating the schemes better contextually
- Changes to the corner detailing to mimic that used on phase 1A, directly responding to the immediate surroundings

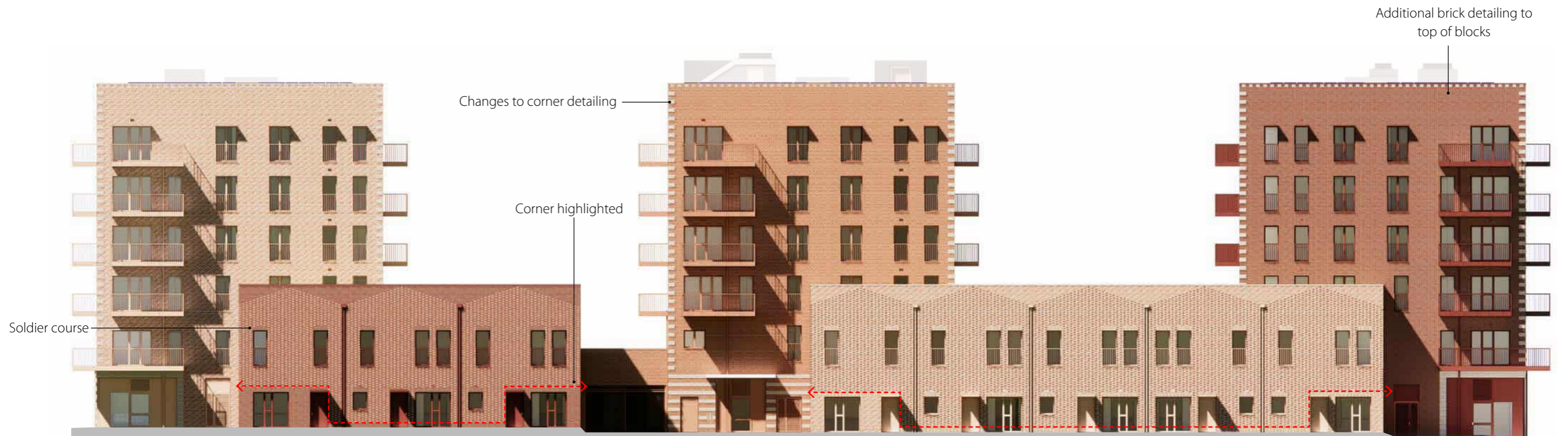
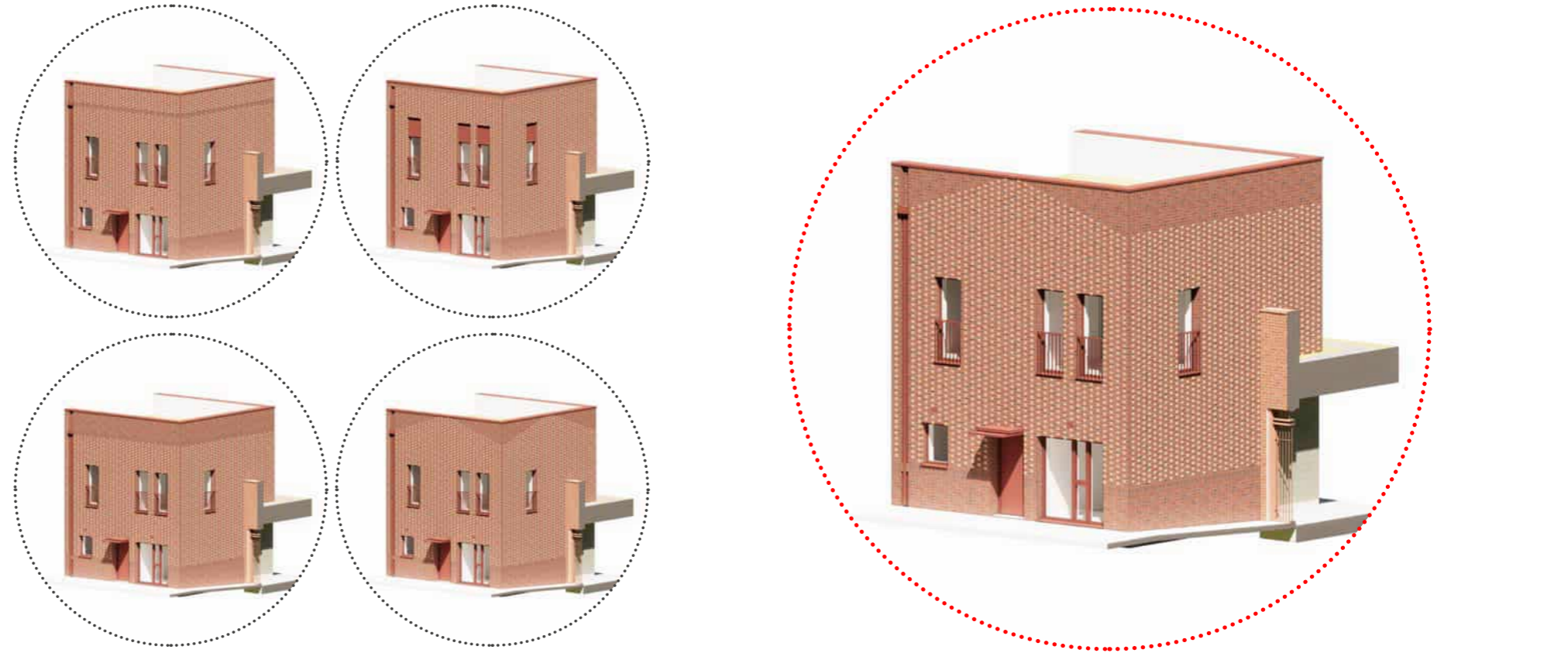

UPDATED IMAGERY SHOWING PROPOSED ELEVATIONAL DESIGN

3.3 PUBLIC CONSULTATION AND FEEDBACK



7TH OCTOBER 2025

PUBLIC CONSULTATION WITH RESIDENTS

A public consultation event was held on the 7th October 2025, at Minet School, adjacent to the site. The event was well attended with members of the client and consultant team available for questions and discussion.

The proposals were positively-received with key feedback as below:

- Comments received from the Minet Infant and Nursery school regarding boundary and privacy
- General support for the revised masterplan approach and detail design
- General support for proposed heights

INTRODUCTION

WELCOME
Welcome to the Avondale Drive Estate community engagement exhibition. Today we are presenting the proposed planning application for the next phases of the Avondale Drive Estate masterplan.

THE TEAM
HILLINGDON
Higgins
PRP

INTRODUCTION

COMPLETED PHASE

KEY BENEFITS
This phase of the masterplan has been completed and is ready for handover to residents.

- 30 homes all for social rent
- New play space created

PHASE 1A

PLANNING APPLICATION PROPOSAL

We are making some improvements to the existing planning application for Avondale Drive Estate, which includes:

- Improved buildings proportions to create more amenity spaces and natural light
- Better proportion of buildings along Avondale Drive
- Better landscape with high quality green spaces and play areas
- Delivering more affordable homes

KEY FEATURES

- 100 new designed homes along Avondale Drive
- Relocation of street side play area to a safer and more convenient location
- 15 metre high residential buildings to improve privacy
- New connection to Hillingdon Park with more amenity for residents to enjoy

MASSING

THE PLANNING APPLICATION

NEXT PHASES
The planning application for the next phases will improve the number of affordable homes with better designs and more green spaces.

PRINCIPLES OF THE DETAILED PROPOSALS

- More affordable and accessible homes across the site
- Better green spaces for residents to enjoy
- Provision of spaces and safe cycle parking areas for residents

KEY FEATURES

- 266 New homes
- 29 Accessible homes
- 75 Parking spaces, including disabled parking

NEXT PHASES

PROPOSED NEXT PHASES GROUND FLOOR

GROUND FLOOR
Homes at ground floor level will have front doors with direct access to the pavement, greenery and the street creating activity along the public areas. There will be easy access to car parking and bin and cycle stores.

KEY BENEFITS

- Proposed large family homes are located on the level
- New green connection to Hillingdon Park
- Accessible homes located across the site
- Improved sense of security along the street with front doors and green spaces

GROUND FLOOR

LANDSCAPE-LED DESIGN

LANDSCAPE APPROACH NEXT PHASES
The green spaces and public realm provide attractive streets with trees. The proposals include areas of play, seating, and tree planting throughout. The proposals provide a direct connection through to Hillingdon Park, improving the ease of connection into the park itself.

PROPOSED GREEN CONNECTION
The Hillingdon green connection street incorporates an attractive green environment with a variety of trees to provide high and medium level being from upper levels for privacy.

LANDSCAPE

PROPOSED TYPICAL HOMES IN THE NEXT PHASES

TYPICAL HOMES
A variety of homes including flats and houses will be provided across these next phases.

KEY BENEFITS

- Family homes to be delivered earlier in the project
- Accessible homes are located across the next phases
- Wide mix of homes on offer

HOMES

ILLUSTRATIVE VIEWS - NEXT PHASES

These views provide a sense of how the next phases will look for residents and visitors.

KEY BENEFITS

- Improved views with more landscaping green spaces and water elements
- A new green connection between Avondale Drive and Hillingdon Park
- Windows and balconies facing streets will provide a better sense of security

VIEWS

MAKING AVONDALE DRIVE ESTATE MORE SUSTAINABLE

SUSTAINABILITY STRATEGY
We will make sure the new Avondale Drive Estate is durable and future-proof, ensuring the development is sustainable, efficient and supports local nature and ecology.

SUSTAINABLE PRINCIPLES

- Warm homes, comfortable, and well-insulated to help reduce energy bills
- Improve green spaces to promote ecology and provide a host of other benefits
- Re-use brick for durability and low maintenance
- Some recycled materials from demolition could be re-used
- Solar panels installation to help save on energy bills
- Installation of electric vehicle charging points
- Heating and hot water will be generated by a new heat pump system

SUSTAINABILITY

WHAT HAPPENS NEXT?

THANK YOU
Thank you for coming and taking the time to visit this engagement event and see the project proposals for Avondale Drive Estate. We really value your feedback and would welcome any thoughts you have on our proposals for the scheme.

Please take a moment to provide your feedback to one of our project team members. Feedback forms are available at the entrance. We kindly ask you to fill one out and share any feedback you may have.

Updates and information on the development can be found at our website: www.hillingdon.co.uk

If you have any questions, please do not hesitate to contact us:
Email: avondaledrive@higginspartnerships.co.uk

Thank you for visiting us today! For any other queries please contact one of the project team members or visit our website.

We have set out an indicative timeline below:

TIMELINE

PUBLIC CONSULTATION AND FEEDBACK

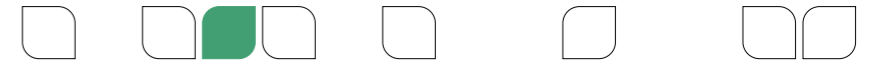

7TH OCTOBER 2025

PUBLIC CONSULTATION WITH RESIDENTS

All written feedback received at the event has been recorded on this page.

These comments have been considered and used to help shape the proposals submitted under this reserved matters application.

The homes look good

During construction, it would be good if the access gate on hiterbroom road can be opened up to minimise traffic disruption
Would like to see more parking.

Well informed for local community.
Insightful consultation.
Architectural design is welcomed.

lovely piece of work. Bravo to the Team!!!

Phase one balconies overlooking the school is concerning for childrens safety.

FEEDBACK FROM THE EVENT

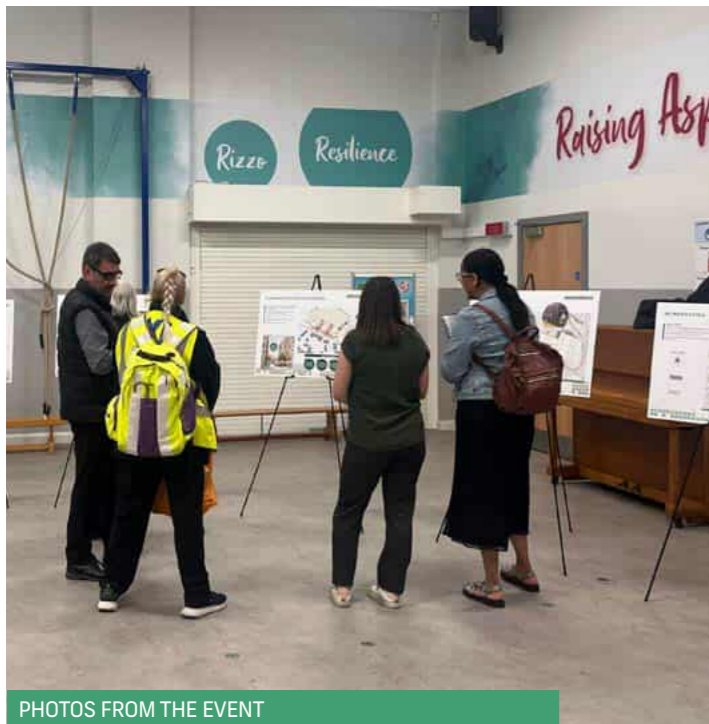

PHOTOS FROM THE EVENT

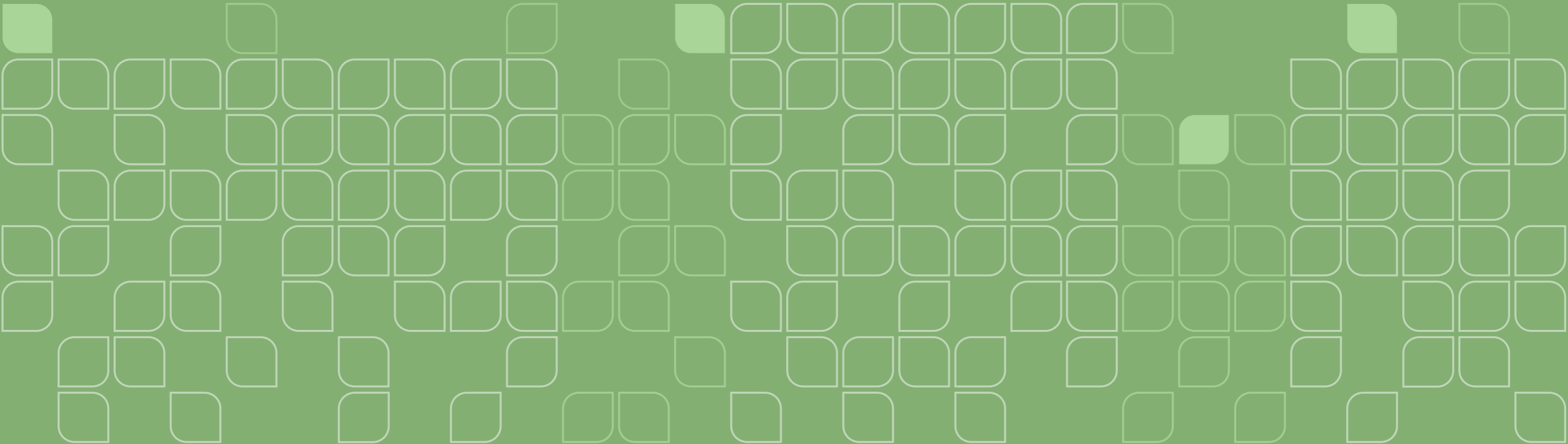

4. THE RESERVED MATTERS

4.1 INTRODUCTION

DETAILED DESIGN PROPOSALS

This section sets out the detailed design of the proposed development and demonstrates its compliance with the controls for the outline area of the Hybrid Planning Permission (as proposed to be amended by application ref. 76551/APP/2025/2861) and the submitted Design Code.

The proposals demonstrate a thoughtful response to the site's context, stakeholder feedback, and the ambition to create a vibrant, sustainable, and inclusive community.

As a comprehensive overview; the proposal is spread across 2 phases of development of the remaining Avondale drive Estate, arranged in 5 main blocks of varying heights up to 10 storeys. 266 new homes are proposed; a mix of duplexes and apartment typologies according with the parameters defined in condition 6 of the Outline Conditions.

Between the 2 phases, a new landscaped, almost exclusively pedestrianised, space connecting Avondale Drive to Hitherbroom park sits at the heart of the proposed development, offering improved access for all locals and new residents to new and existing green spaces. Existing trees are to be retained where possible with a large number of new trees contributing to an impressive Urban Greening Factor of 0.52.

The development will support new residents further with dedicated car parking under privately accessed landscaped podium gardens, new secure cycle parking in line with London Plan requirements and all servicing spaces considered and appropriately designed from the offset, as demonstrated through this section.



VIEW SOUTH ALONG ABBOTSWOOD WAY

4.2 PROPOSED DEVELOPMENT EXTENTS

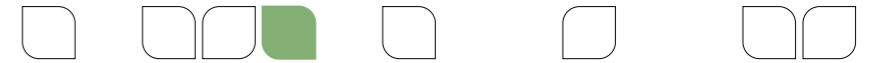

SIMILARITY WITH THE OUTLINE ILLUSTRATIVE MASTERPLAN

Broadly, the outline of the proposed development aligns strongly to that of the illustrative masterplan which was referred to in the Design and Access Statement Addendum included in the Outline submission. See bottom right of page for reference.

This includes allowing a reasonable buffer around the root protection area of existing trees along the site boundary.







COMPLIANCE WITH PARAMETER PLANS

Critically however, the footprint of the proposed detailed design sits within the development constraints imposed by Parameter Plan 1 of the Outline submission. This is demonstrated in the overlay shown on the right.



OVERLAY OF PROPOSAL WITH DEVELOPMENT ZONES FROM PARAMETER PLAN 1

Key

-  Outer Building Footprint of Development Zone +250mm deviation of building outline permitted for construction tolerance, excluding above ground projections.
-  Public Realm and Landscape Improvements
-  Proposed Open Space and Landscape/Public Realm Enhancement
-  Minimum distance between buildings (excluding any projections)
-  Minimum distance between projections
-  Minimum width of communal amenity
-  Projected Zone beyond outer building footprint (+/-2m)



ILLUSTRATIVE MASTERPLAN (REFERENCED IN OUTLINE APPLICATION)

M / 001	M / 005	M / 025
M / 132	M / 142	M / 194

4.3 PROPOSED MASSING

4.3.1 Storey Heights

STOREY HEIGHTS

The proposed general massing and storey heights align with the illustrative massing referred to in the Outline submission, which was developed in accordance with the Outline parameters and other controls.

The proposed massing is highly articulated with changes in massing occurring where there are steps in the building's footprint, and helps to express the character areas defined in the Design Code.

DETAILED FLOOR TO FLOOR HEIGHTS

Floor to floor heights for the detailed proposal are as follows:

Ground to First (phase 2)	3.9m+
Ground to First (phase 1b)	4.2m
First to Second	3.45m
Typical Upper to Upper	3.15m
Roof finish to top of parapet	1.1m

Within a dwelling, the minimum floor to ceiling height will be at least 2.5m for at least 75% of the Gross Internal Area.



PROPOSED STOREY HEIGHTS

Section Key (below)

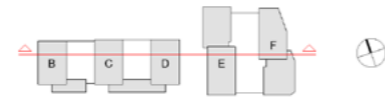

Key (above)

X Storey Height

- A / 003
- A / 041
- M / 001-4
- M / 006
- M / 013-16
- M / 237-42
- M / 255-56
- M / 266-67
- M / 269
- M / 285-86
- M / 296-97

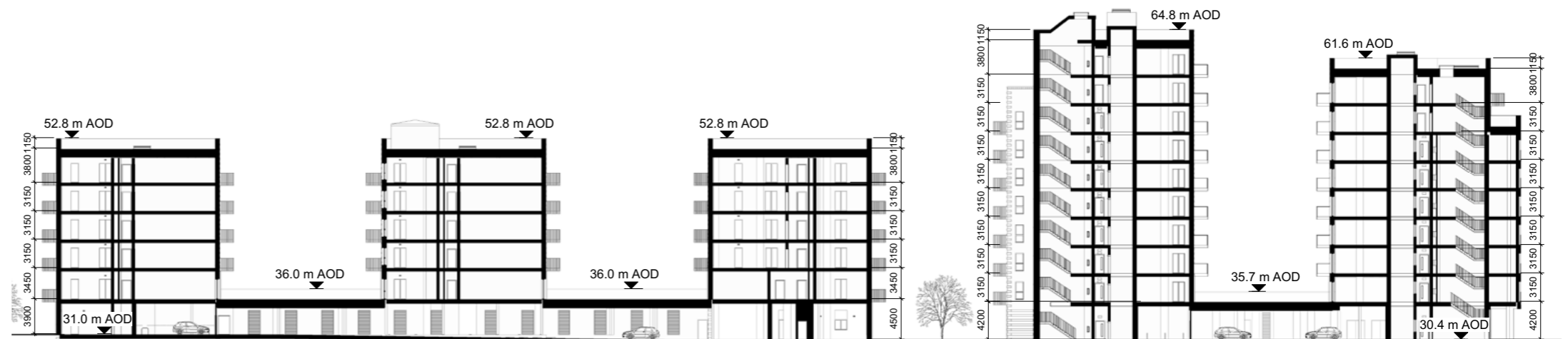

PROPOSED SECTION WITH STOREY HEIGHTS

PROPOSED MASSING

4.3.2 Compliance with Outline requirements

COMPLIANCE WITH PARAMETER PLANS

Parameter Plan 2 of the Outline submission sets out the maximum extents of the building heights for each development zone. The overlay, shown right, compares each maximum AOD with that achieved by the reserved matters proposal.

Below, a section through the proposal shows the massing sitting comfortably within the constraints of the parameter plan.



Section Key (below)

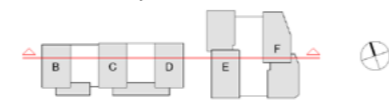

Stair access and roof plant permitted to exceed maximum development height as per parameter plan

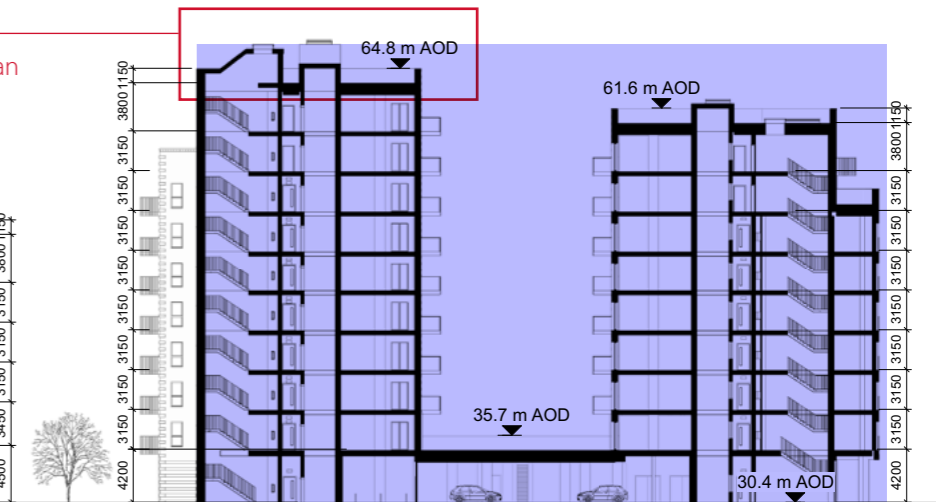
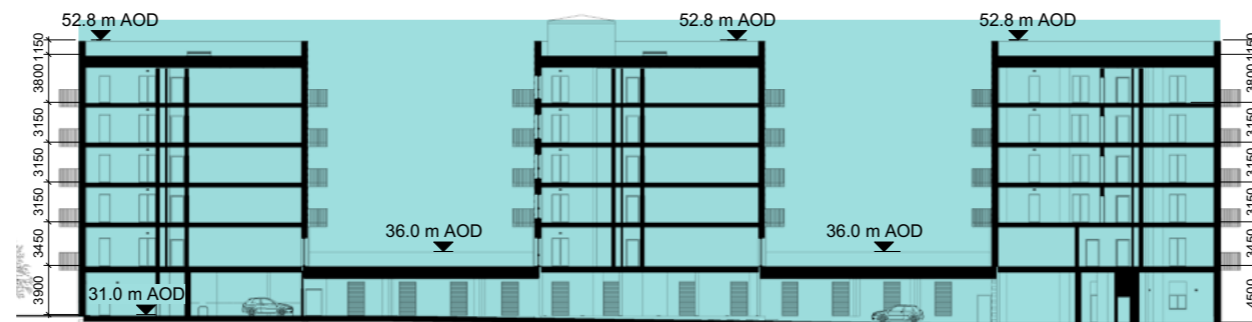

PROPOSED SECTION WITH MAXIMUM DEVELOPMENT HEIGHTS OVERLAY

A / 003

M / 001-4

M / 013-17

M / 020

4.4 PHASING

PHASING PLAN

This phasing plan outlines the strategic implementation of the Avondale Drive Estate redevelopment, illustrating the sequential delivery of the proposed blocks and public realm improvements. The phased approach ensures efficient construction while minimising disruption to existing residents and the surrounding community.

The proposed development covered in this RMA (phases 2 and 1B) will be delivered in accordance with the phasing plan submitted with the pending s73 application (to be secured through revisions to the wording of planning condition 7) - with Phase 1b expected to commence in Spring 2027 and Phase 2 expected to commence in Summer 2027.



PHASING PLAN



Key (above)

- Phasing Boundary
- Outline Planning Application red line (context only)
- Reserved Matters Application red line
- - - Phase 1A Red line (context only)
- ▨ Phase 2 - Underground drainage works

4.5 HOUSING QUANTUM AND MIX



The proposed Housing Mix has been revised through pre-application consultation to create a mixed and balanced community, offering a variety of types, tenures and sizes, which could help meet local housing needs.

The total number of homes accords with the proposed revised wording of condition 5 (pending determination) which will allow up to 266 homes within the reserved matters (outline area). It also accords with the percentage ranges set out in the proposed revised wording of condition 6 (subject to approval of the s73 application) i.e. 32% - 36% 1 bedroom units, 42% - 46% two bedroom units and 20% - 24% 3 and 4 bedroom units.

This proposed housing quantum results in a proposed density of 278 homes per hectare for the total outline development, within the constraints of condition 9 which allows for a density of up to 285 homes per hectare.

Note: The tenure mix and distribution shown on this schedule is indicative only and will be controlled separately through the s106 agreement

Phase 1B + 2 - Social Rent													
	1B2P 50m ²	1B2P W 58m ²	2B3P 63m ²	2B3P W 75m ²	2B4P 70m ²	2B4P W 80m ²	2B4P D 80m ²	3B5P 86m ²	3B4P W 95m ²	3B5P D 96m ²	4B6P D 106m ²	4B7P D 115m ²	Total
Total	24	10	12	5	31	0	2	22	3	6	1	4	120
Mix	28%		42%					26%			4%		100%

Phase 1B + 2 - Private													
	1B2P 50m ²	1B2P W 56m ²	2B3P 61m ²	2B3P W 70m ²	2B4P 70m ²	2B4P W 80m ²	2B4P D 80m ²	3B5P 86m ²	3B4P W 86m ²	3B5P D 96m ²	4B6P D 106m ²	4B7P D 115m ²	Total
Total	60	0	0	2	54	8	0	22	0	0	0	0	146
Mix	41%		44%					15%			0%		100%

Phase 1B + 2 Total													
	1B2P	1B2P W	2B3P	2B3P W	2B4P	2B4P W	2B4P D	3B5P	3B4P W	3B5P D	4B6P D	4B7P D	Total
Total	84	10	12	7	85	8	2	44	3	6	1	4	266
Mix	35%		43%					20%			2%		100%

4.6 PHASE 2 - GROUND FLOOR PLAN

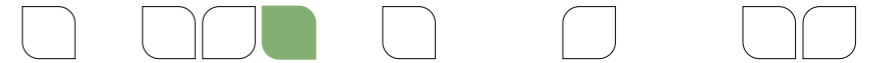

The Phase 2 ground floor plan sets out residential lobbies and street-facing homes to activate and engage the public realm. Parking and support facilities, including bin stores, cycle storage and plant rooms, are located away from the frontage and discreetly concealed within podium.

This arrangement preserves an uninterrupted, pedestrian-friendly frontage and ensures a high-quality public realm and pedestrian experience.

The footprint of this block sits wholly within the outer building footprint of the Development Zone 3 as defined on Parameter Plan 1 (as amended)



- Outline Planning Application red line (context only)
- Reserved Matters Application red line

- Access**
- External Cycle Store access
 - Duplex access
 - External Bin Store / Plant access
 - External Lobby access

- Non- Residential**
- Residential Lobby and Cores
 - Bins
 - Cycles
 - Plant
 - Car Park

- Residential**
- 3 Bed
 - 2 Bed
 - 1 Bed

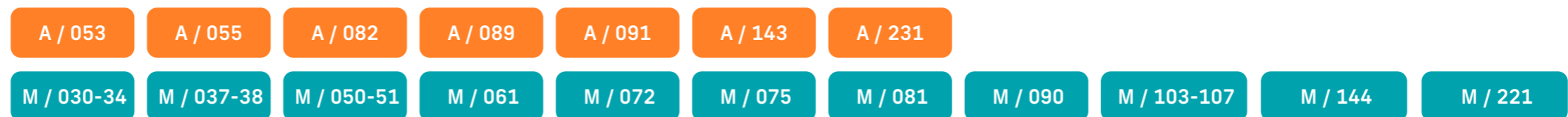
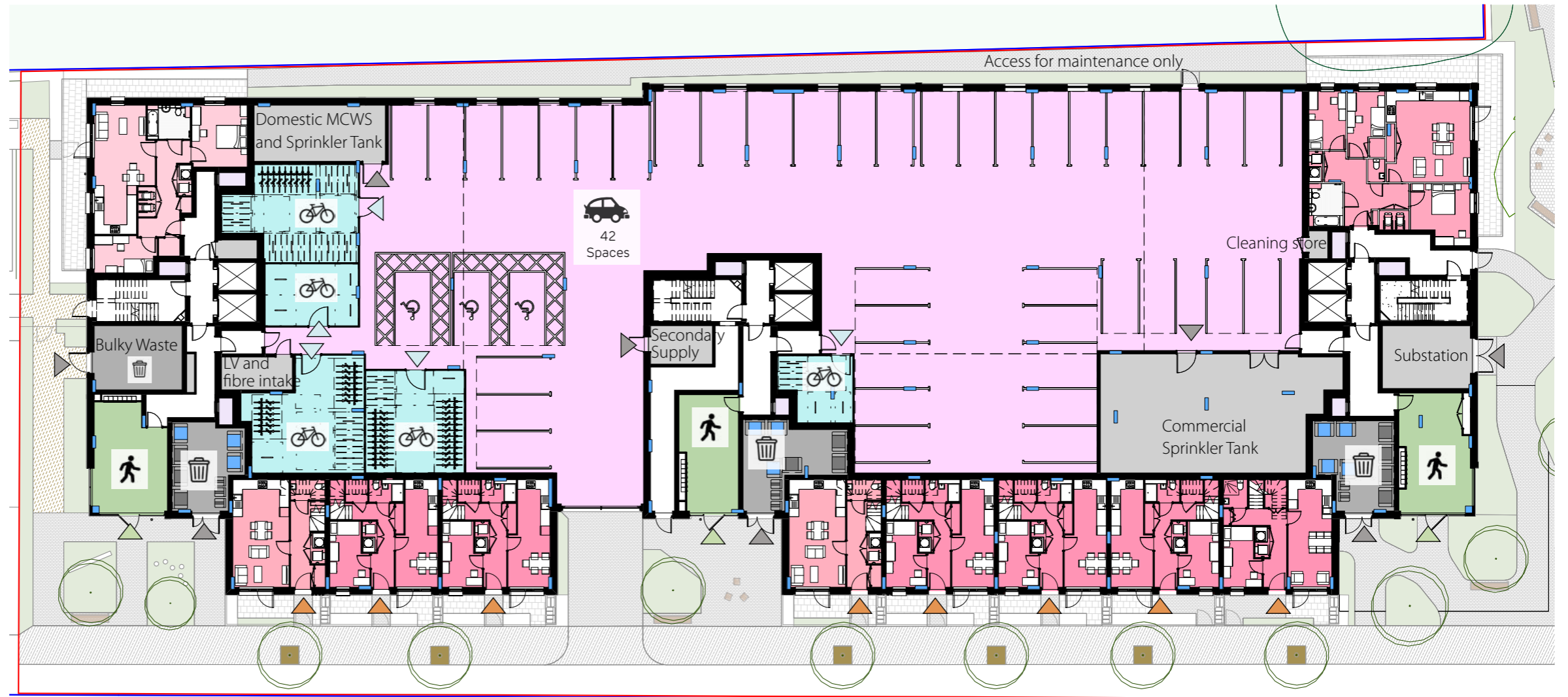

4.7 PHASE 2 - FIRST FLOOR PLAN

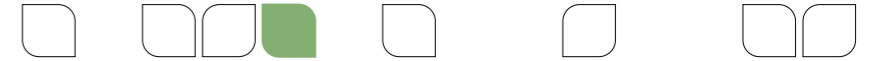

The Phase 2 First Floor Plan illustrates the layout of apartments, communal podium garden accesses and private garden serving units that face the podium. The configuration is designed to maximise daylight and privacy while improving connectivity to external amenity spaces. Maintenance access points have also been incorporated.

The dimensions of the two podium gardens ensure compliance with the minimum width of the communal amenity and the separation distances between buildings and projections defined in Parameter Plan 1.

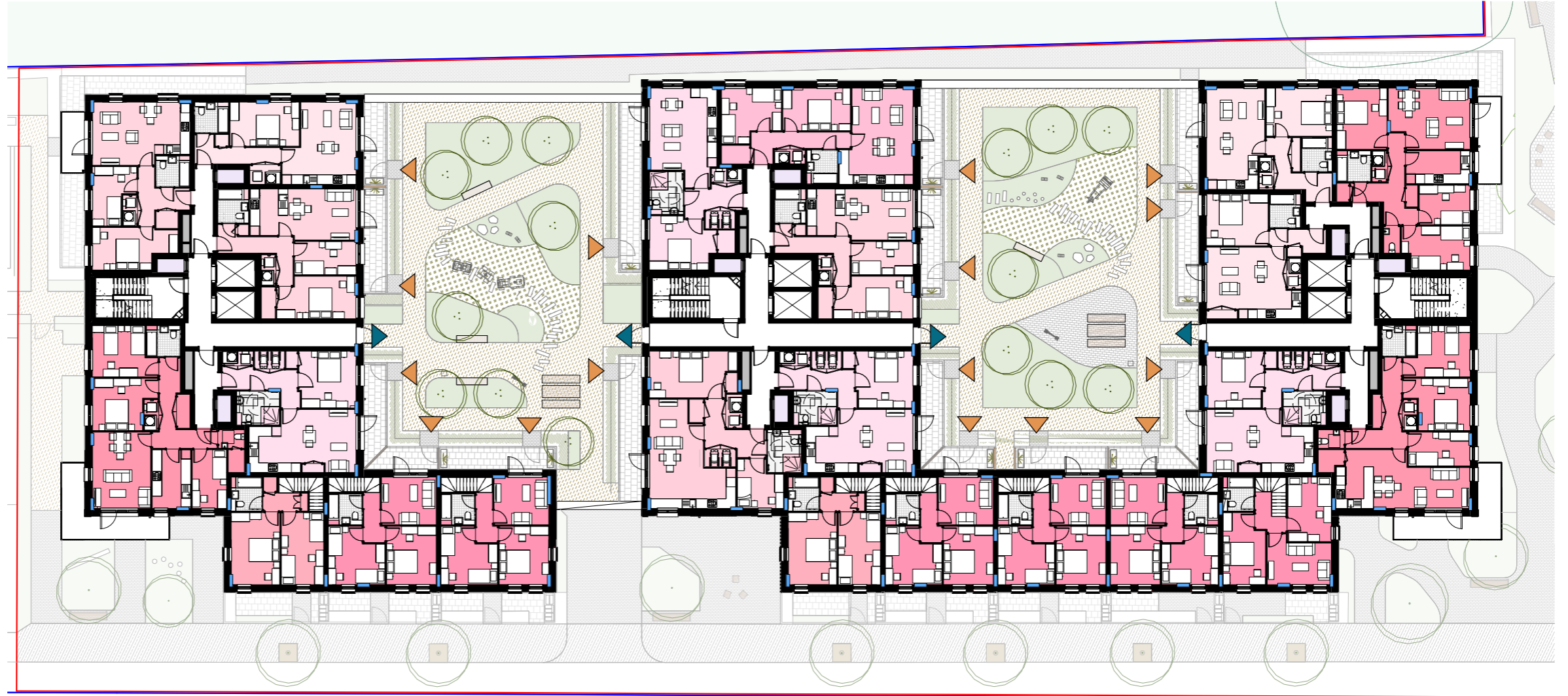

- Outline Planning Application red line (context only)
- Reserved Matters Application red line

Access

- ▶ Communal Podium Access
- ▶ Private Podium Access

Residential

- 3 Bed
- 2 Bed
- 1 Bed

A / 088 - 89

A / 148

M / 147

M / 159-60

M / 297

4.8 PHASE 2 GROUND FLOOR STRATEGIES

4.8.1 Active Frontages

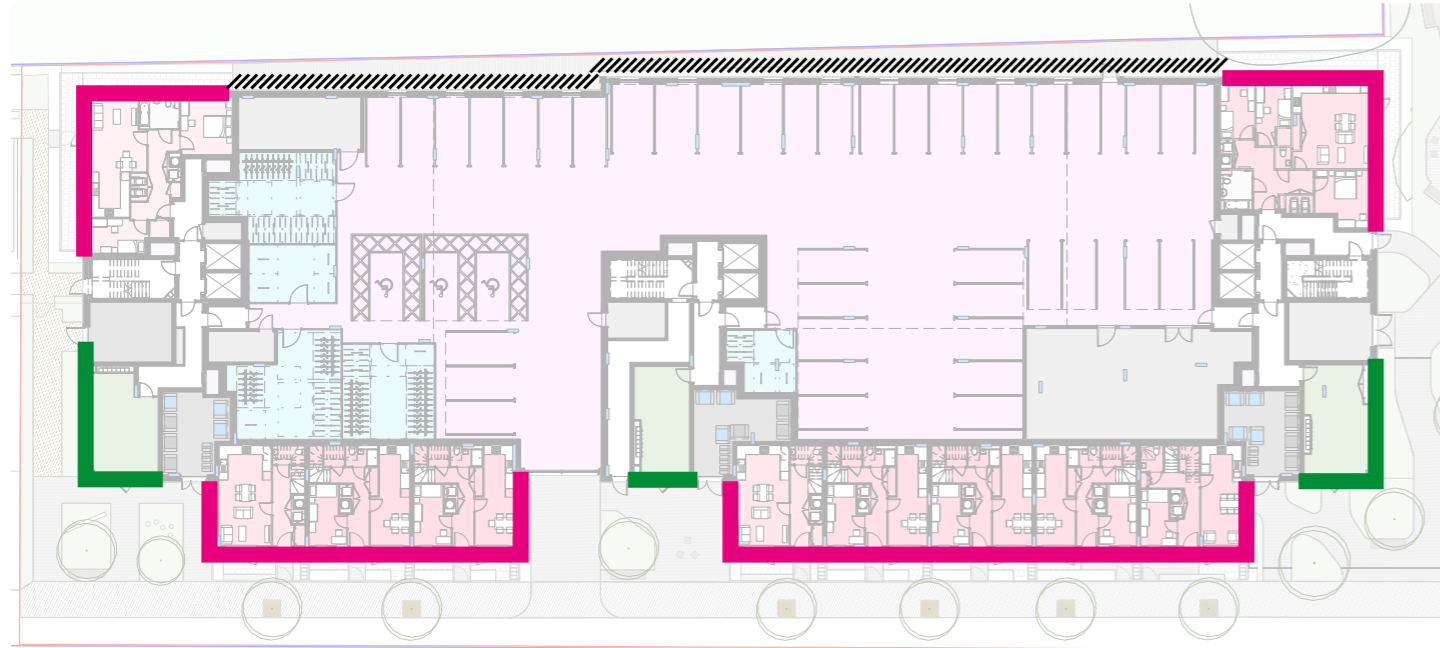

A clear and highly legible diagram across the ground floor of phase 2 is set up, with maximised primary active frontages along Avondale Drive overlooking the street and new entrance approaches, and secondary active frontages to the East and West engaging with the play spaces and new landscaped connection to Hitherbroom park. The high level of active frontages to the South, East and West allows for passive surveillance over all public spaces, providing a safety benefit to the local community.

In contrast, the north elevation deliberately does not allow many views out to minimise opportunity for overlooking to the school playing fields located behind, as requested during consultation. A green wall is proposed along this stretch of the facade instead, aligning with non-active frontage requirements set out by the Design Code.

Key

- █ Residential Active Frontage
- █ Non-Residential Active Frontage (lobbies and postal store)
- ▨ Non-active frontages to the North Elevation (proposed green wall along GF facade)

4.8.2 Lobbies and Postal Strategy

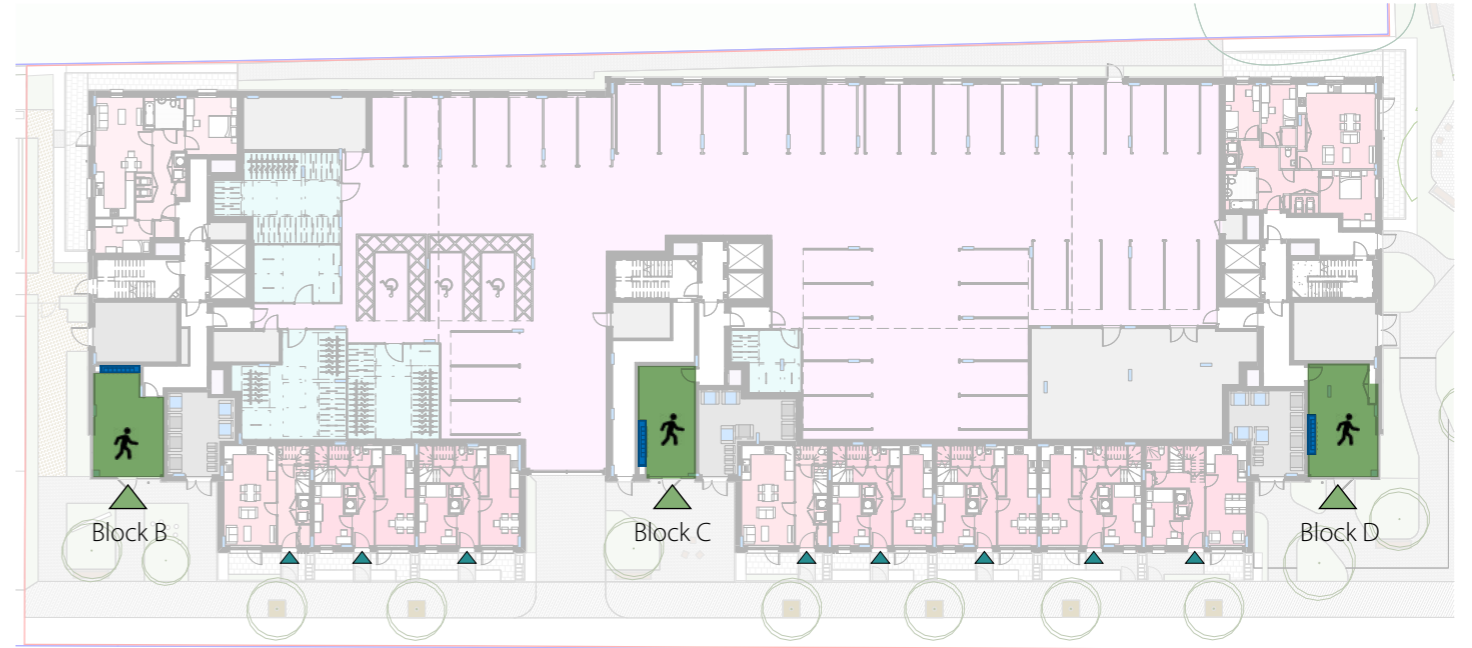

All the lobbies for phase 2 are accessed from Avondale Drive with trees and landscaping in the external spaces leading up to the entrances. Blocks B and D are dual aspect, with glazing wrapping the corner of the blocks to provide views out and greater visibility to the entrances.

Each lobby contains letterboxes for all residents of that specific block. Combined, these will serve all residents other than those living in the duplexes facing Avondale Drive, who will have their own letterboxes through their front doors.

Key

- █ Residential Lobbies
- █ Letterboxes within residential lobbies
- ▲ Letterboxes within front door (duplexes)
- ▲ Postal Delivery Access

A / 010 A / 042

M / 030 M / 033-34 M / 036-38 M / 051 M / 127 M / 140 M / 240 M / 267

PHASE 2 GROUND FLOOR STRATEGIES

4.8.3 Refuse Strategy

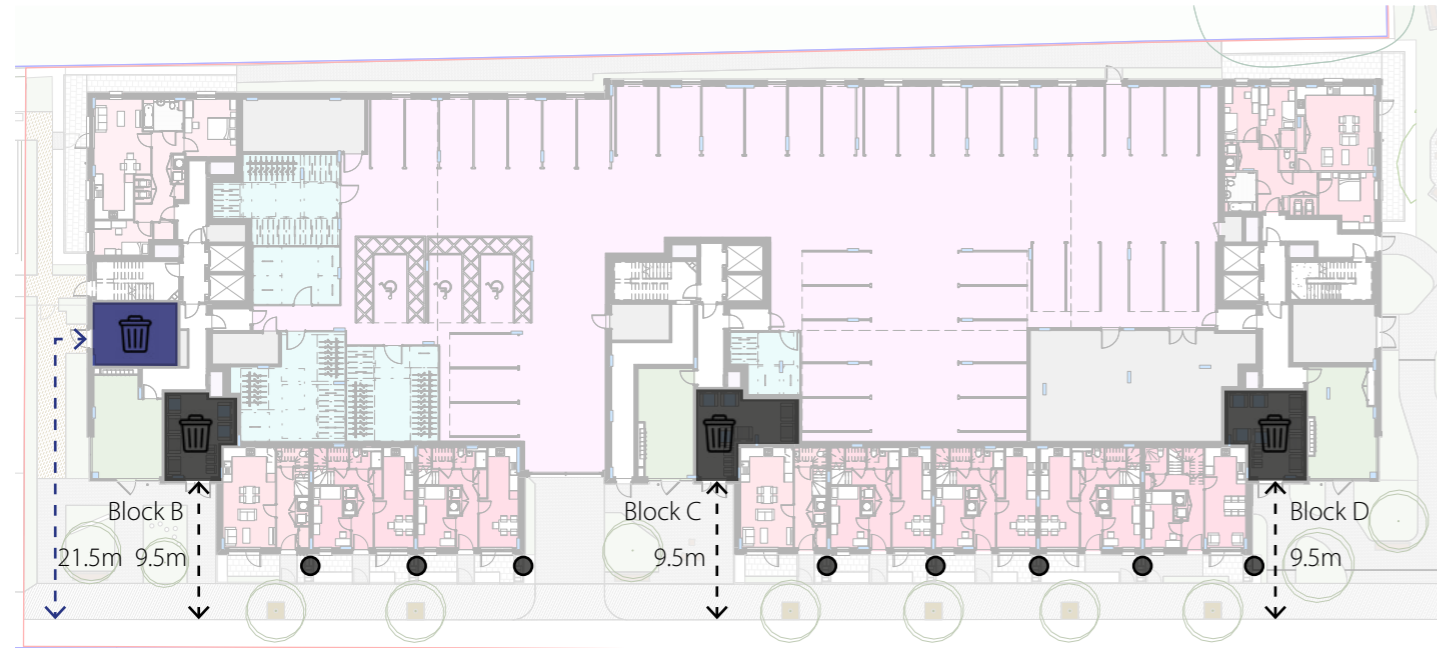

Each communal bin store is sized according to LBH waste requirements and designed to BS5906:2005 Standards. They are located along the South elevation so as to minimise drag distances for collection crew, whilst minimising their dominance in the overall facade.

Each communal bin store in phase 2 is accessed externally, within 10m drag distance from the road for collection, and within the 30m recommended walking distance to drop-off as per Building Regs Part H6.

Individual, secure, external bin stores are provided to each of the duplexes fronting Avondale Drive. These will be located in the private defensible space fronting the road and integrated into the landscaping.

For more details on the refuse strategy, please refer to the Operational Waste Management Strategy Report, prepared by Velocity.

Key

- Communal Bin Store
- Communal Bulky Waste Store
- Distance to kerb
- Private External Bin Store (duplexes)

4.8.4 Fire and Access Strategy

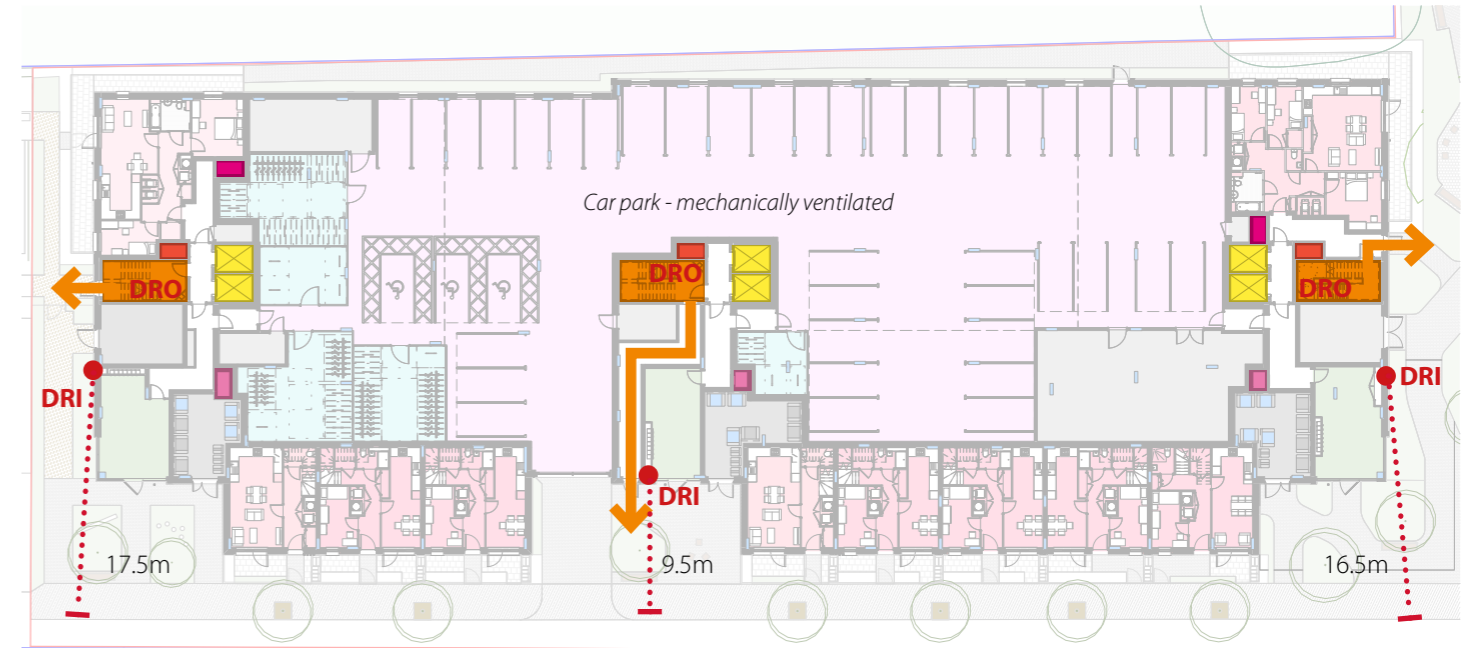

As a non-Higher Risk Building under the definitions of the Building Safety Act 2022, phase 2 proposes a single stair-core to each block, with 2 x dual fire-fighting and evacuation lifts. Each core lobby is ventilated by a dedicated natural smoke shaft. Each corridor providing access to residential units is also ventilated by a dedicated natural smoke shaft.

Each staircase has a dedicated, protected means of escape which terminates at ground floor, and provides access from a dry riser outlet to every level for fire-fighting purposes. Dry riser inlets are located on the external facades of each main lobby, allowing easy access in an emergency scenario.

For more details on the fire strategy, please refer to the Outline Fire Strategy report, prepared by Introba. A detailed Fire Strategy will be submitted pursuant to condition 31 prior to commencement of development.

Key

- Dual Fire-fighting and Evacuation Lifts
- Staircase with fire-fighting access and dedicated, protected Means of Escape at Ground Floor.
- Natural Smoke Shaft Ventilating Core Lobby
- Natural Smoke Shaft Ventilating Corridor with Residential Access
- Natural Smoke Shaft with Potential for use Ventilating Corridor / Non-residential
- DRI ● Dry Riser Inlet
- DRO □ Dry Riser Outlet

A / 117 A / 119-21

M / 081 M / 116 M / 118

PHASE 2 GROUND FLOOR STRATEGIES

4.8.5 Parking and Access Strategy

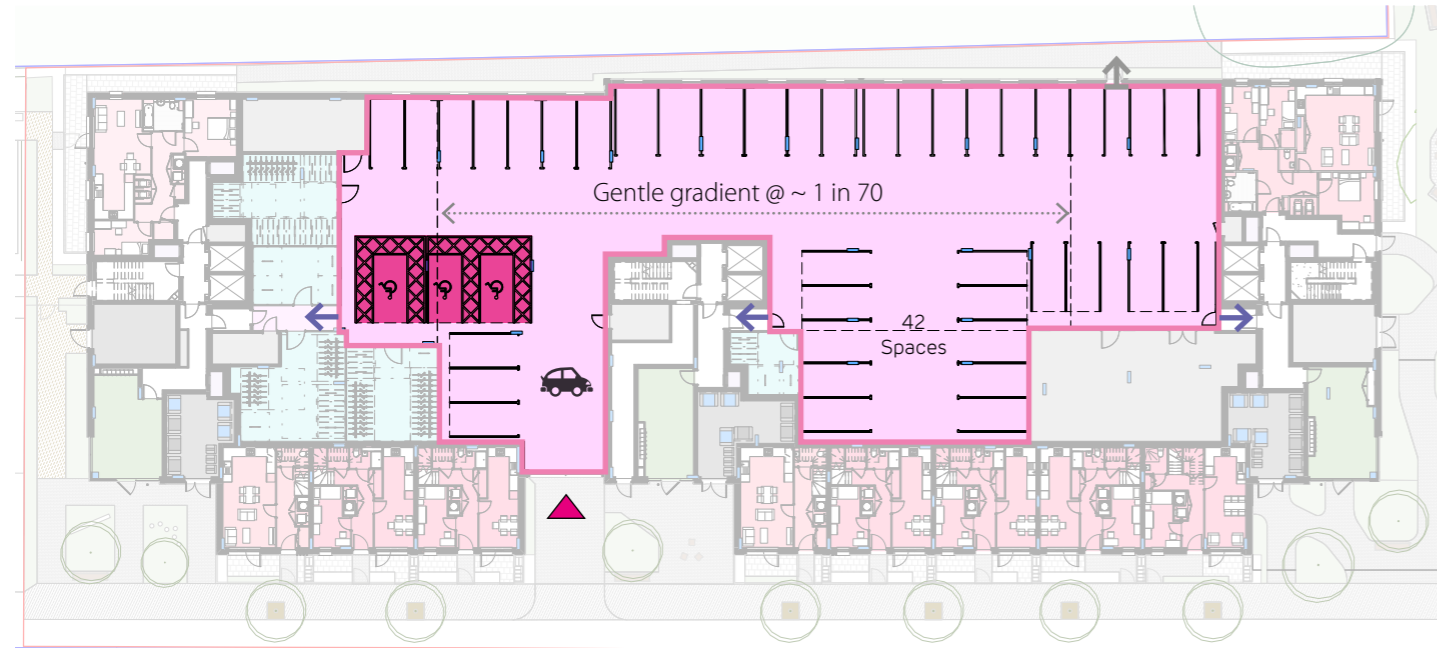

The detailed design for phase 2 proposes an under podium car park accessible by vehicle from Avondale Drive, providing a total of 42 spaces, inclusive of 3 wheelchair accessible spaces.

Pedestrian access/exit points into each core are proposed, providing means of escape and day-to-day access via the lobbies. Access to the external space to the North will be for maintenance only via a door on the North facade.

All access points accord with the requirements placed on the design by Parameter Plan 3 of the Outline submission.

For more details on the parking strategy, please refer to the Parking Design and Management Plan, prepared by Markides.

Key

- Under podium car park
- Accessible parking spaces
- Pedestrian exit
- Maintenance access only
- Vehicular entrance/exit

RELEVANT EXTRACT FROM OUTLINE SUBMISSION - PARAMETER PLAN 3

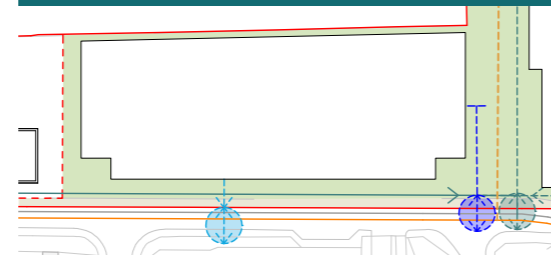

4.8.6 Cycle Strategy

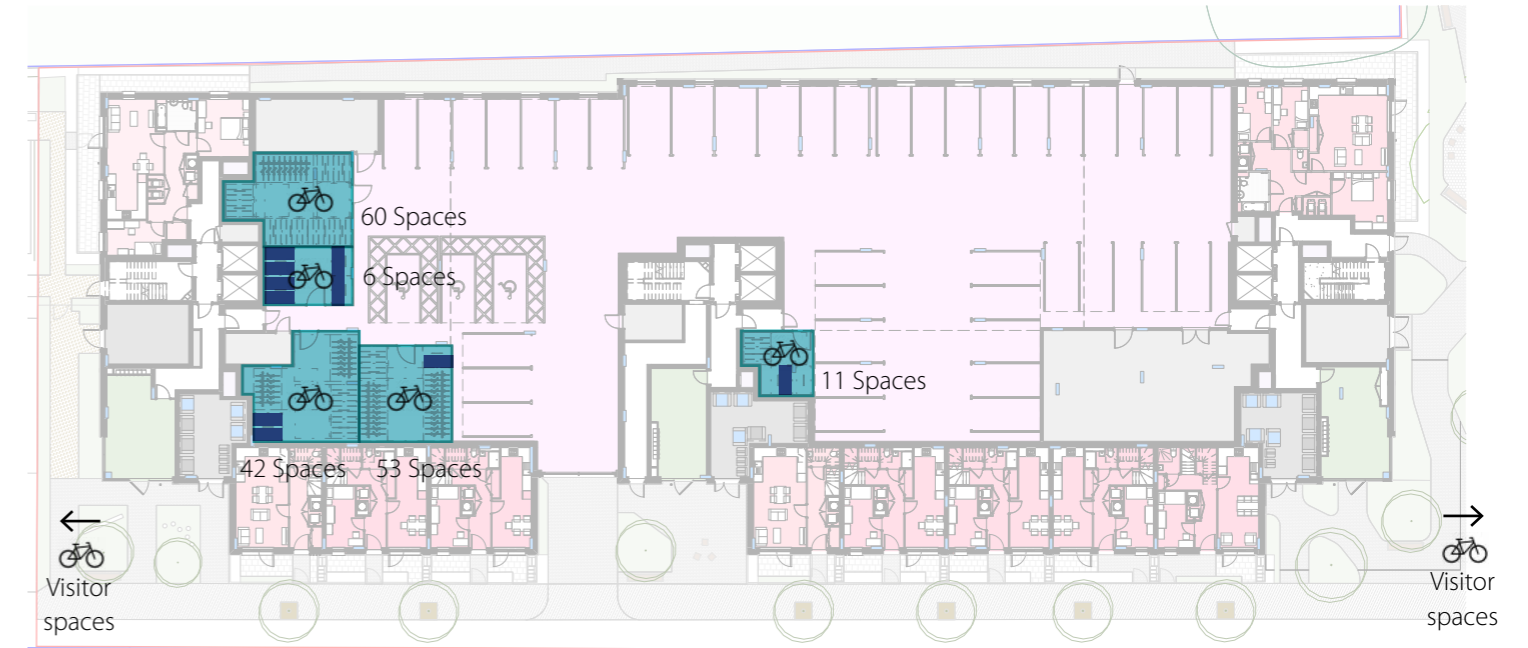

The cycle strategy follows the London Plan policy requirements for provision, aligning with the Outline design submission. Of the total provision, a percentage split by cycle stand type is proposed, catering to various accessibility requirements:

- 75% double stacked
- 20% standard Sheffield stands
- 5% larger Sheffield stand spaces capable of accommodating alternative accessible types of cycles

Long-term spaces for all dwellings are provided in these stores. The layout and design of which follows guidance provided in the London Cycling Design Standards.

Visitors' cycle parking spaces are provided as standard Sheffield stands in the landscaped park connection between phase 2 and 1b. These are located mainly in the landscaped park connection between phase 2 and 1b.

Key

- Secure communal cycle store
- Dedicated spaces for larger, 'accessible' bicycles

London Plan Policy Provision Requirements:

Requirement: Policy	
T5: Cycling	
	Space
Studio	1
1B2P	1.5
2B plus	2

Proposed percentage split of cycle stand type:

Percentage %	
Double	75
sheffield	20
larger bikes	5

A / 110 A / 114

M / 038 M / 103-07 M / 111-13 M / 115

Phase 2 Cycle Parking				
	Double stacked	Single Sheffield	Larger Sheffield	Total
Policy	128	34	9	171
Proposed	128	35	9	172

4.9 PHASE 1B - GROUND FLOOR PLAN

The Phase 1B Ground Floor Plan illustrates the layout of residential units and ground level service facilities, including bin stores, cycle storage and plant rooms. Duplex entrances and resident lobbies are carefully sited to activate the street and create strong, welcoming frontages.



- Outline Planning Application red line (context only)
- Reserved Matters Application red line

Access

- External Cycle Store access
- Duplex Entrance / Flat with external access
- External Bin Store / Plant access
- External Lobby access

Non- Residential

- Residential Lobby and Cores
- Bins
- Cycles
- Plant
- Car Park

Residential

- 4 Bed
- 3 Bed
- 2 Bed
- 1 Bed

A / 055	A / 089	A / 143	A / 231
M / 030-34	M / 037-38	M / 050-51	M / 061
M / 072	M / 075	M / 081	M / 090
M / 103-07	M / 144	M / 221	

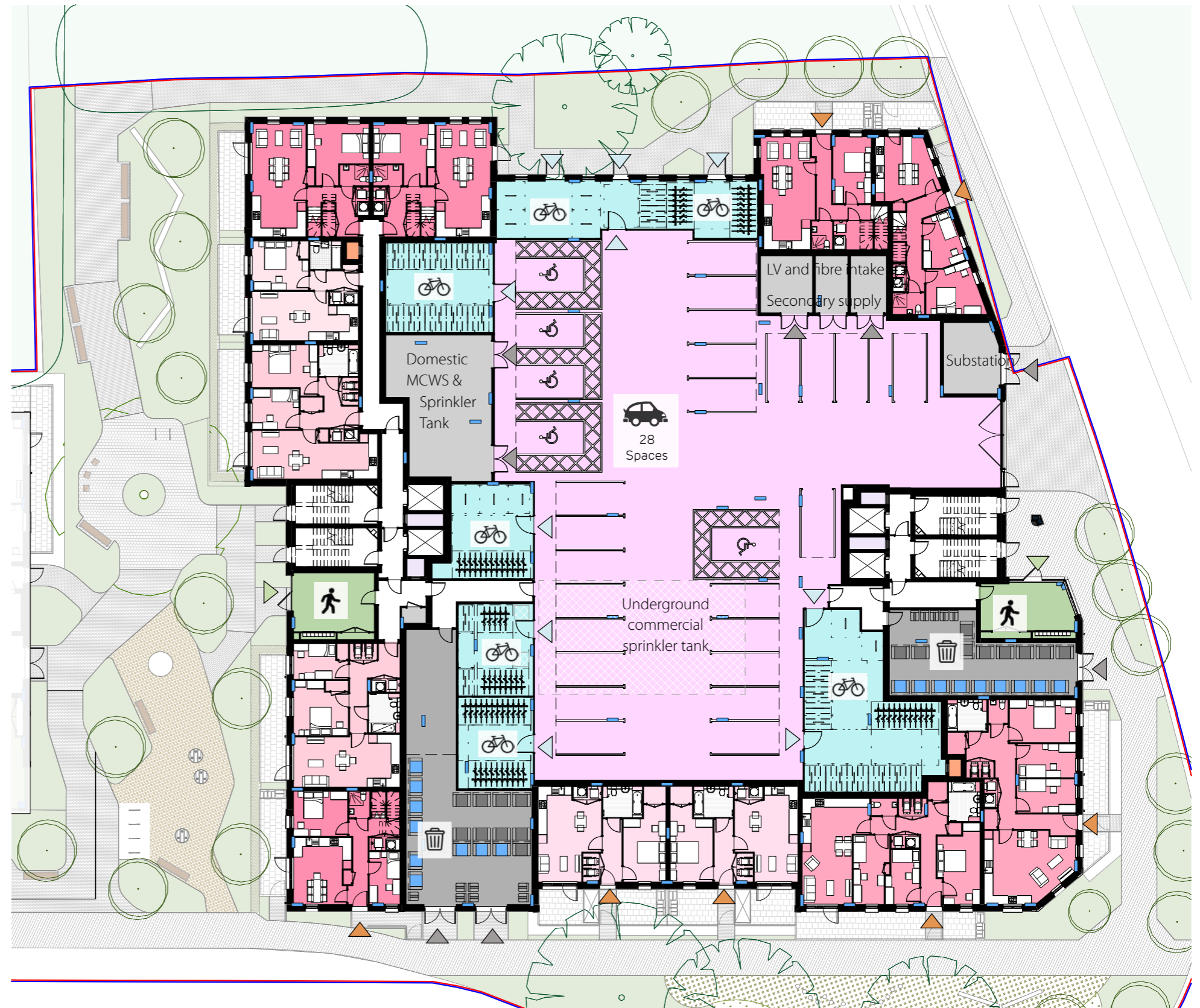

4.10 PHASE 1B - FIRST FLOOR PLAN

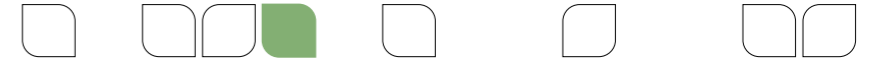

The Phase 1B First Floor Plan illustrates the layout of apartments, communal podium garden accesses and private garden serving units that face the podium. The configuration is designed to maximise daylight and privacy while improving connectivity to external amenity spaces.

The balanced mix of Social Rent and Private units is configured to optimise natural light, privacy and connection to external amenity spaces, ensuring a high quality of living with a tenure blind approach.

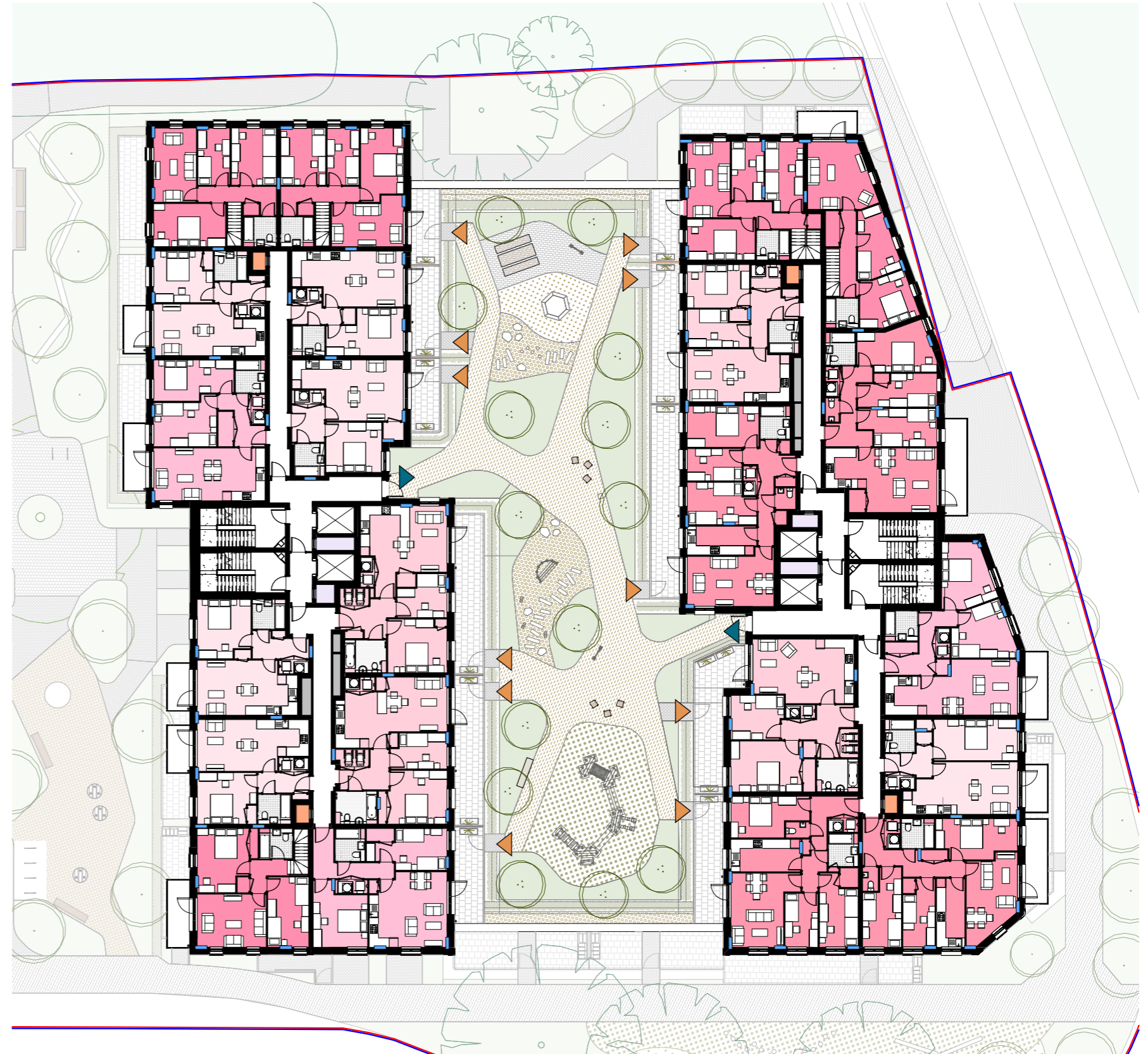

- Outline Planning Application red line (context only)
- Reserved Matters Application red line

Access

- ▶ Communal Podium Access
- ▶ Private Podium Access

Residential

- 4 Bed
- 3 Bed
- 2 Bed
- 1 Bed

A / 088-89

A / 148

M / 147

M / 159-60

M / 297

4.11 PHASE 1B GROUND FLOOR STRATEGIES

4.11.1 Active Frontages

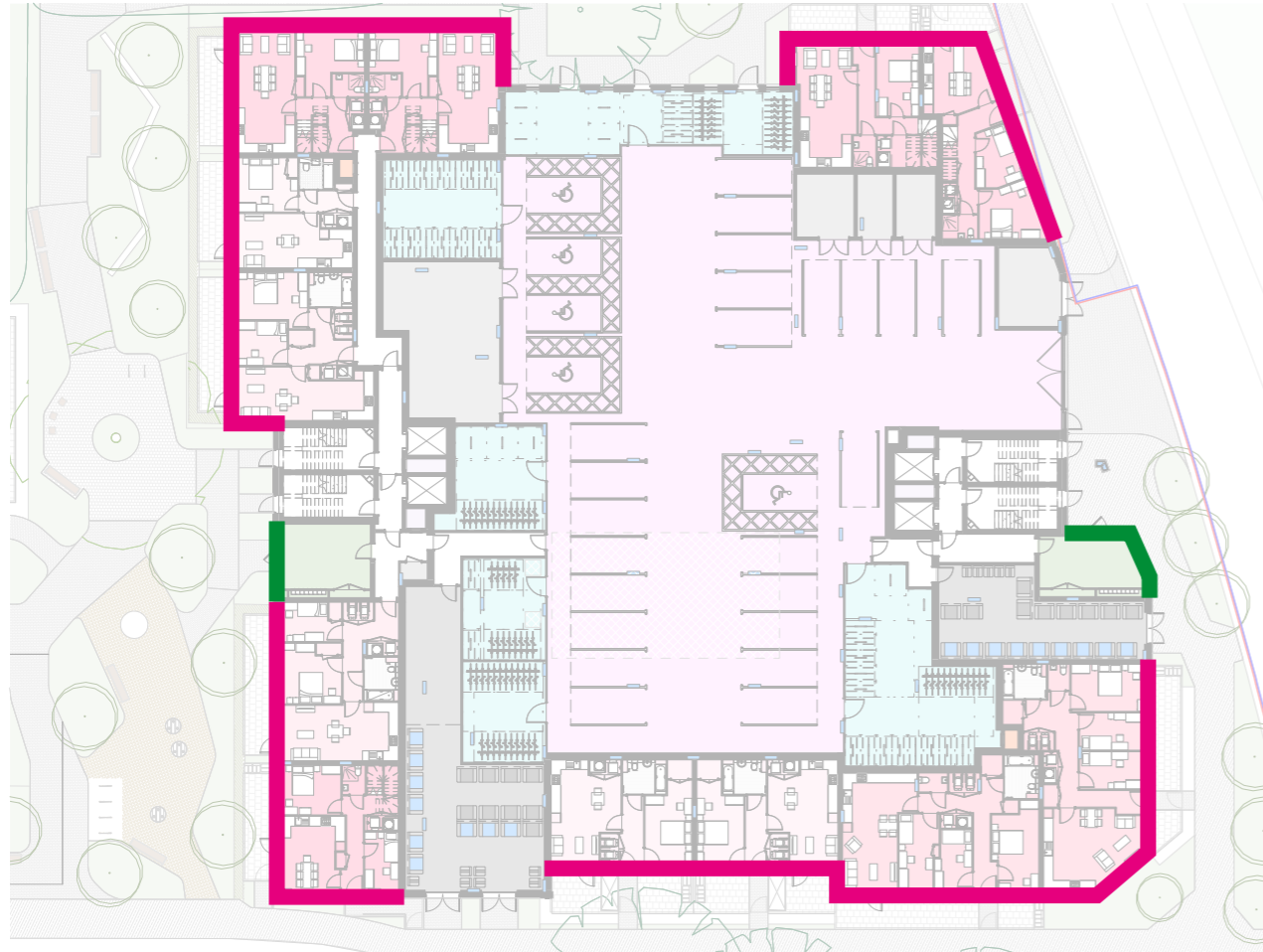

The phase 1b development is surrounded by pedestrian access routes and as such maximises active frontages all the way around the perimeter of the block to ensure all public spaces are reasonably overlooked.

This allows for passive surveillance, providing a safety benefit to the local community, particularly to the West fronting the new proposed landscaped connection to Hitherbroom Park. This will naturally help ensure the space is used appropriately and kept nice for the benefit of all.

To the North, windows are proposed on the return facades into the Northern edge of the podium to ensure this space is still overlooked and kept actively engaged, without the use of single-aspect north-facing dwellings.

Key

- █ Residential Active Frontage
- █ Non-Residential Active Frontage (lobbies)

4.11.2 Lobbies and Postal Strategy



Phase 1B lobbies are accessed from the East/West into the centre of each block, with landscaping leading up to the entrances.

Each lobby contains letterboxes for all residents of that specific block. Combined, these will serve all residents other than those with their own private external accesses, who will have their own letterboxes through their front doors.

Key

- █ Residential Lobbies
- █ Letterboxes within residential lobbies
- ▲ Letterboxes within front door (duplexes)
- ▲ Postal Delivery Access

- A / 010
- A / 042
- M / 030
- M / 033-34
- M / 036-38
- M / 051
- M / 127
- M / 140
- M / 240
- M / 267

PHASE 1B GROUND FLOOR STRATEGIES

4.11.3 Refuse Strategy

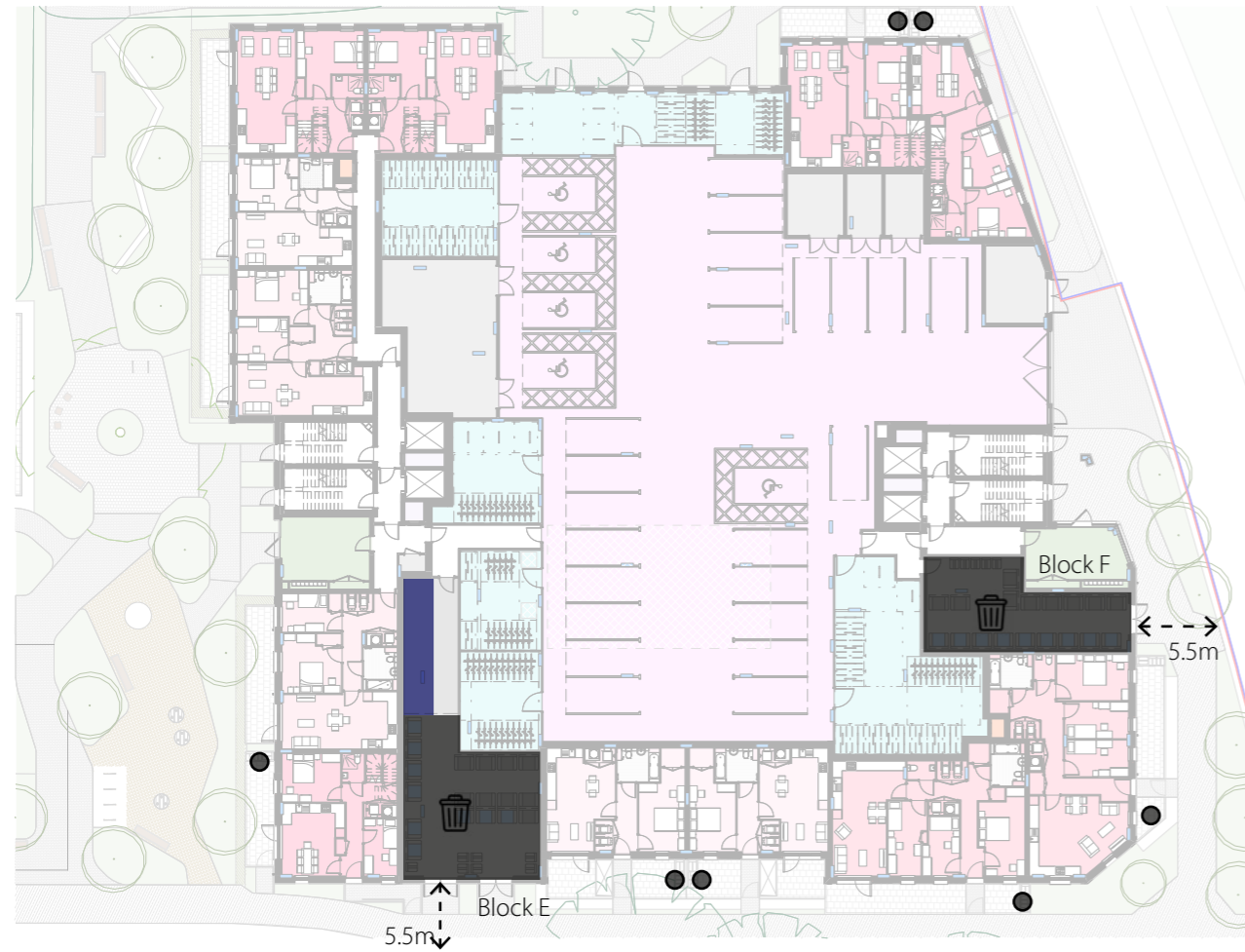

Each communal bin store is sized according to LBH waste requirements and designed to BS5906:2005 Standards. They are located close to existing roads on the South and East sides so as to minimise drag distances for collection crew, well within the recommended 10m drag distances.

Each communal bin store in phase 1B is accessed internally by residents for convenience, along the routes most residents would take to leave the building on an ordinary basis.

Individual, secure, external bin stores are provided to each of the ground floor flats and duplexes with their own private entrances. These will be located in the private defensible space fronting the road and integrated into the landscaping.

For more details on the refuse strategy, please refer to the Operational Waste Management Strategy Report, prepared by Velocity.

- Key**
- Communal Bin Store
 - Communal Bulky Waste Zone
 - Distance to kerb
 - Private External Bin Store (duplexes)

- A / 117
- A / 119-21
- M / 081
- M / 116
- M / 118

4.11.4 Fire and Access Strategy



As a Higher Risk Building under the definitions of the Building Safety Act 2022, phase 1B proposes a dual stair-core to each block providing two independent means of escape in an emergency, each with 2 x dual fire-fighting and evacuation lifts per core. Each core lobby is ventilated by a dedicated natural smoke shaft. Each corridor providing access to residential units is also ventilated by a dedicated mechanical smoke shaft which, when in operation, pulls smoke through allowing it to be replaced with fresh air supplied by the shaft in the lobby.

Each staircase has a direct means of escape out at ground floor, and provides access from a dry riser outlet to every level for fire-fighting purposes. Dry riser inlets are located on the external facades of either the main lobby or direct into the staircase, allowing easy access in an emergency scenario.

To ensure the maximum 18m access distance to the dry riser inlet is not exceeded in Block E, hardscaping allowing for a fire vehicle to park in an emergency scenario has been incorporated into the landscaping design of the park connection space between phases 1B and 2.

- Key**
- Dual Fire-fighting and Evacuation Lifts
 - Staircase with fire-fighting access and dedicated, protected Means of Escape at Ground Floor.
 - Natural Smoke Shaft Ventilating Core Lobby
 - Mechanical Smoke Shaft Ventilating Corridor with Residential Access
 - Mechanical Smoke Shaft with Potential for use Ventilating Corridor / Non-residential
 - Fire vehicle emergency parking on hardscaping along park connection. Accessible from Avondale Drive
 - DRI • Dry Riser Inlet
 - DRO Dry Riser Outlet

For more details on the fire strategy, please refer to the Outline Fire Strategy report, prepared by Introba. A detailed Fire Strategy will be submitted pursuant to condition 31 prior to commencement of development.

PHASE 1B GROUND FLOOR STRATEGIES

4.11.5 Parking and Access Strategy

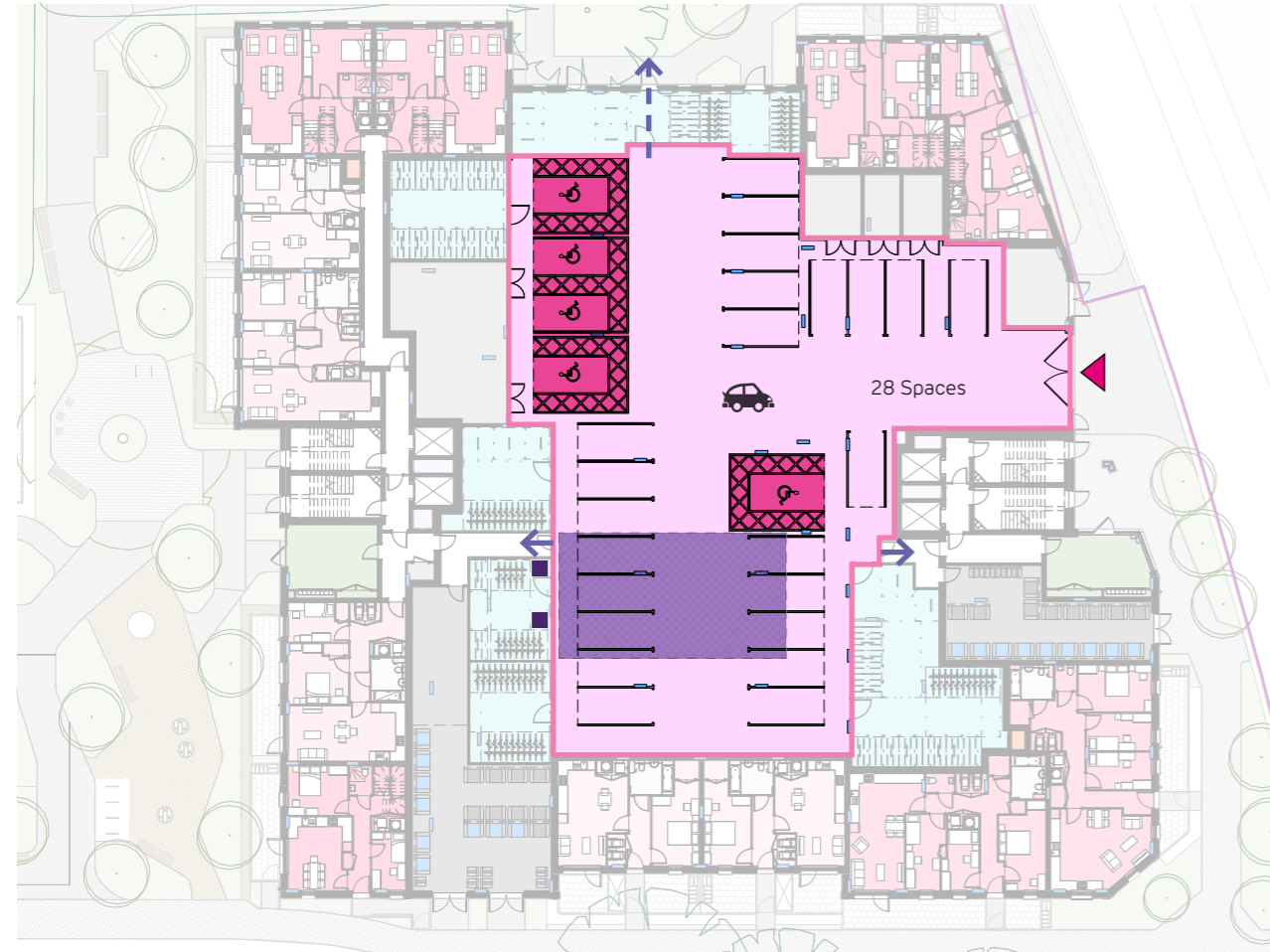

The detailed design for phase 1B proposes an under podium car park accessible by vehicle from Abbotswood Way, providing a total of 28 spaces, inclusive of 5 wheelchair accessible spaces.

Pedestrian access/exit points into each core are proposed, providing means of escape and day-to-day access via the lobbies. An additional pedestrian exit to the North is provided, offering sufficient escape routes in an emergency scenario.

The commercial sprinkler tank for this phase will be located underneath this car park, with 2 access points in the adjacent cycle stores. The exact sizing of the tank and location of access points will be scoped in more detail at the next stage of design.

All access points accord with the requirements placed on the design by Parameter Plan 3 of the Outline submission.

For more details on the parking strategy, please refer to the Parking Design and Management Plan, prepared by Markides.

Key

- Under podium car park
- Accessible parking spaces
- Pedestrian exit
- Underground commercial sprinkler tank (sizing indicative)
- Access hatch for underground commercial sprinkler tank (exact location indicative)
- Vehicular entrance/exit

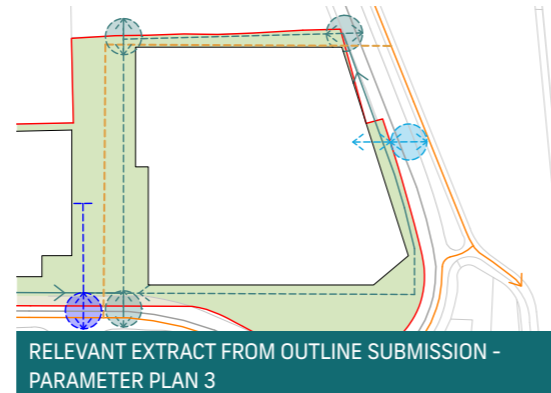

A / 110 A / 114

M / 038 M / 103-07 M / 111-13 M / 115

4.11.6 Cycle Strategy



The cycle strategy follows the London Plan policy requirements for provision, aligning with the Outline design submission. Of the total provision, a percentage split by cycle stand type is proposed, catering to various accessibility requirements:

- 75% double stacked
- 20% standard Sheffield stands
- 5% larger Sheffield stand spaces capable of accommodating alternative accessible types of cycles

Long-term spaces for all dwellings are provided in these stores, other than 2 x 1B2PW flats where the store will be provided in the front garden. The layout and design of the main stores follow guidance provided in the London Cycling Design Standards.

Visitors' cycle parking spaces are provided as standard Sheffield stands in the landscape, shared between development phases. These are located mainly in the landscaped park connection between phase 2 and 1b.

Key

- Secure communal cycle store
- Dedicated spaces for larger, 'accessible' bicycles
- Private store in front garden, accommodating 2 bikes

London Plan Policy Provision Requirements:

Requirement: Policy T5: Cycling	
	Space
Studio	1
1B2P	1.5
2B plus	2

Proposed percentage split of cycle stand type:

Percentage %	
Double	75
sheffield	20
larger bikes	5

Phase 1B Cycle Parking					
	Double stacked	Single Sheffield	Larger Sheffield	Private Store	Total
Policy	234	62	16	4	316
Proposed	234	62	16	4	316

4.12 SITE WIDE STRATEGIES

4.12.1 Site Levels Strategy

The site levels strategy has been developed with inclusive design in mind; it allows for all level changes in the landscape to be gradual with no significant changes in the landscaping other than short areas of ramps, which are designed with ADB part M requirements in mind.

The internal ground floor proposed levels align to the external levels where possible and ensure no steps or ramps to any communal accessed spaces. All level changes are at a gradient of more than 1:20, and occur in BOH spaces like car parks so as to minimise impact.

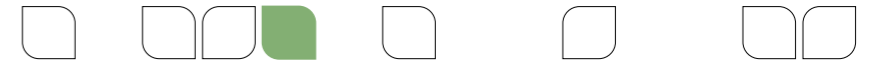

- Key**
- 31.0m AOD
 - 30.7m AOD
 - 30.4m AOD
 - 30.3m AOD
 - Variable @ 1:20 or shallower
 - External Area of gentle gradient 1:20 or shallower
 - External Area of ramp 1:12 - 1:20



SITE WIDE STRATEGIES

4.12.2 Secured By Design

20TH OCTOBER 2025

SBD WORKSHOP

On the 20th October, a meeting was held with Robert Palin from the Metropolitan police to discuss the design proposals.

Support for the proposed outline masterplan and detail design was expressed including the proposed active frontage strategy, lobby strategy and general massing.

A few further early-stage design considerations were discussed as annotated on the plan below, with some more technical considerations lightly touched on and a view to arranging a follow up meeting at technical stage.



Key

- 1.8m fence
- Potential access control points (TBR at later stage)
- Secure fenced line between phases 1A and 2
- ▲ Gated access to phase 1A
- Amenity space with landscape design considerations

Benches not to be located too close to ground floor dwellings to discourage aggravation between neighbours/others using public spaces

Secure line between phases 1A and 2, with gated access preferred. Phase 1A playspace kept for residents only.
Comments incorporated into latest landscape design.

1.8m high fences between amenity spaces and maintenance area



Single doors preferred over double doors to all resident accessed spaces, including lobbies, cycle stores and bin stores (where accessed externally)

Indicative entrance access control strategy, with levels of secure lines (front entrance, lobby to corridor and/or core entrances). Approach to be reviewed at technical design stages

'Standard' bench design encouraged; allows for easy removal later if required. Good lighting required in public space landscape design

A / 223-25

M / 050

M / 219-22

SBD CONSIDERATIONS AND POTENTIAL ACCESS STRATEGY

4.13 PHASE 2 - TYPICAL FLOOR PLAN

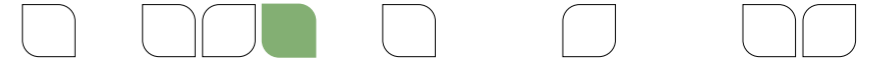

The Phase 2 typical floor plan illustrates upper level residential layouts that maximise natural light and ventilation to habitable rooms through efficient apartment arrangements. The communal corridor strategy limits the distance from the furthest apartment door to the lift core to under 7.5 m, improving accessibility, wayfinding and emergency egress. All stairwells include external windows to provide natural daylight and ventilation.

All dwelling layouts meet the Nationally Described Space Standards (NDSS), providing functional and comfortable homes.

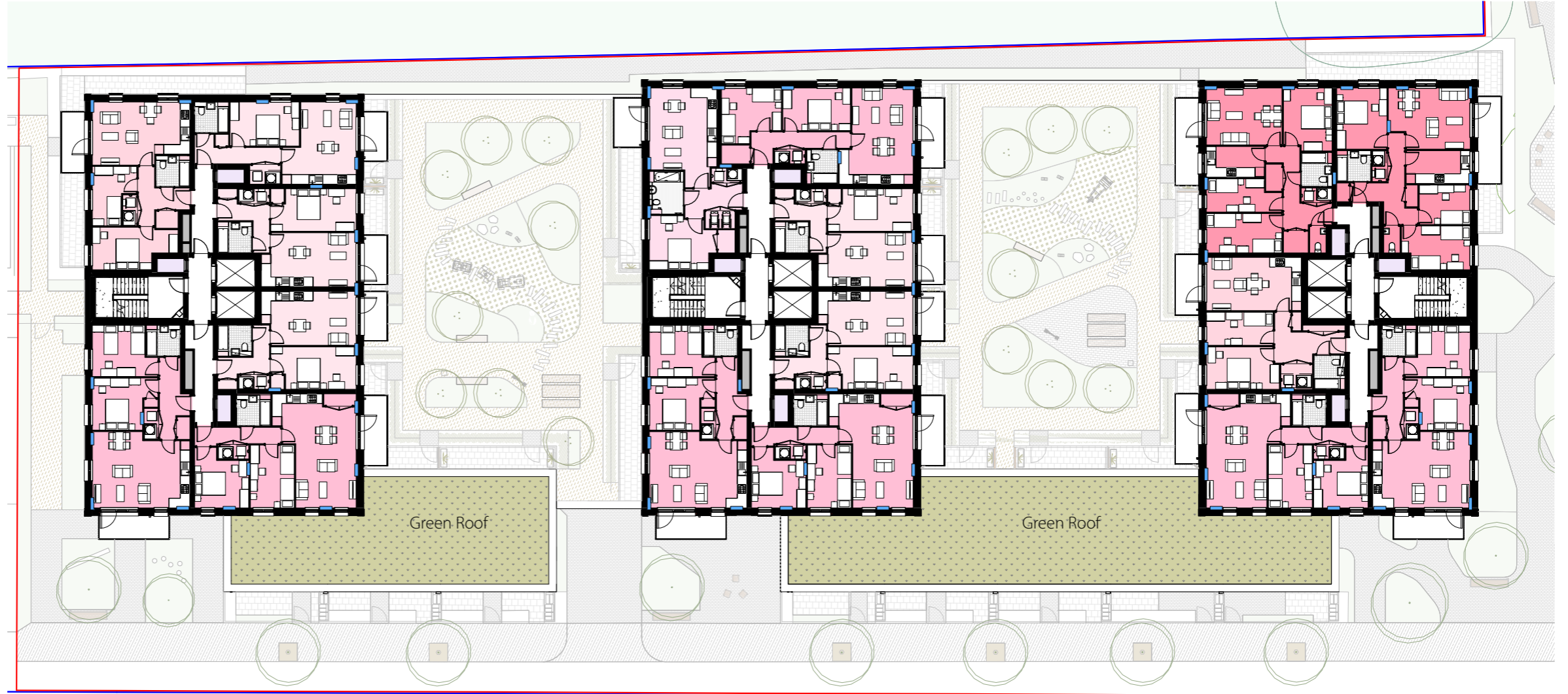

- Outline Planning Application red line (context only)
- Reserved Matters Application red line

Residential

- 3 Bed
- 2 Bed
- 1 Bed

- M / 072
- M / 075
- M / 081
- M / 090

4.14 PHASE 1B - TYPICAL FLOOR PLAN

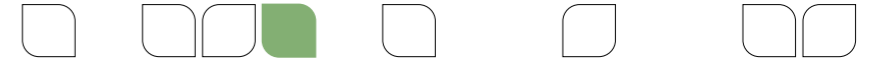

The Phase 1B typical floor plan presents a representative layout of the upper level residential accommodation. It shows efficient internal arrangements that maximise natural light and ventilation to habitable rooms. The mix of social rent and private units is organised to meet the Nationally Described Space Standards (NDSS), providing functional, tenure blind and comfortable homes. A staggered building form breaks down the length of the internal corridor: groups of four to five units to the north and south form smaller zones served by a central lift and staircase, improving privacy and circulation.

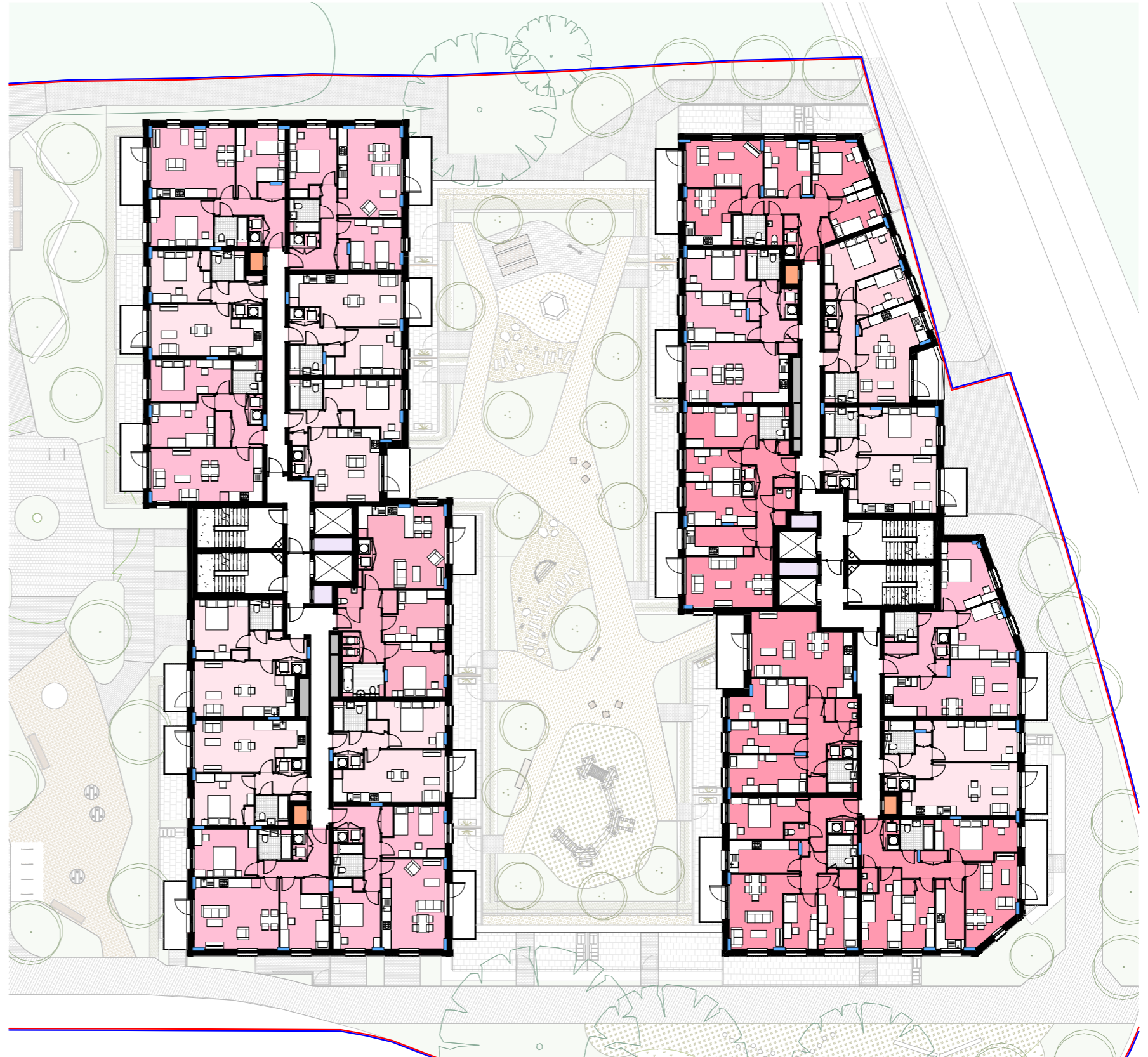

- Outline Planning Application red line (context only)
- Reserved Matters Application red line

Residential

- 3 Bed
- 2 Bed
- 1 Bed

- M / 072
- M / 075
- M / 081
- M / 090

4.15 SITE WIDE UPPER FLOOR STRATEGIES

4.15.1 Daylight, privacy and overlooking strategy

The distances between each block aligns with the Outline design parameters established in Parameter Plan 1 - Development zones. This allows for good levels of daylight to penetrate the proposal into the podium spaces and for all units to receive good daylight and privacy.

To mitigate overlooking onto the school playing fields on the other side of the site boundary, no balconies are proposed along the phase 2 northern facade. No balconies are also proposed on the North of block E in proximity of the existing trees, or primarily facing the East elevation of phase 1A where there is an area of tight proximity, as allowed in the Outline design.

For more details on daylight, please refer to the Daylight and Sunlight Report, prepared by EB7.

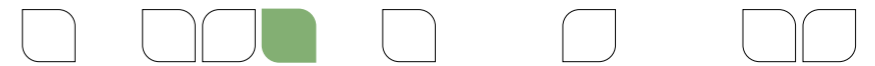

Key

- Distance between buildings
- No balconies facing school fields to North
- No primary balcony frontage where there is a tight proximity to phase 1a block
- No balconies along block E northern boundary due to proximity to existing trees along boundary line

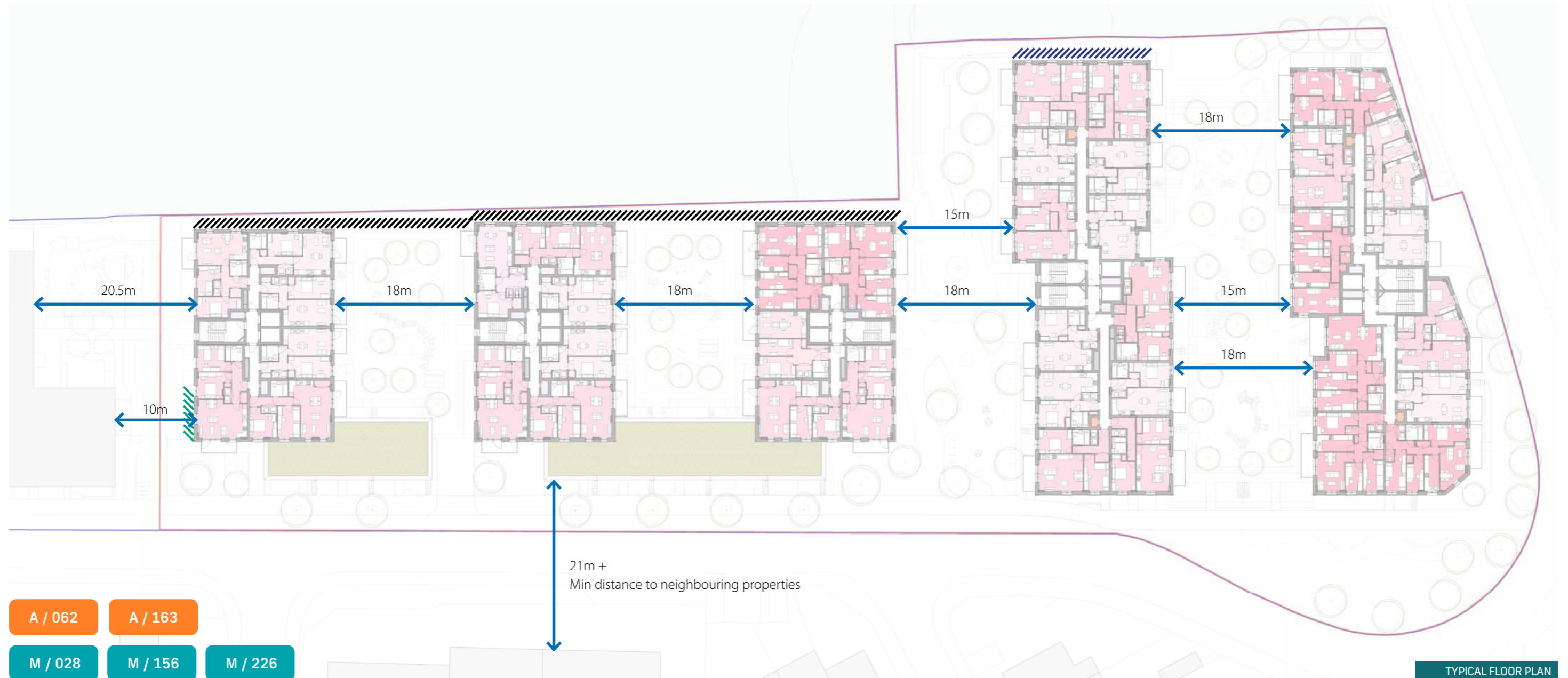

SITE WIDE UPPER FLOOR STRATEGIES

4.15.2 Dual Aspect

Dual aspect units have been maximised within the parameters of the Outline design.

There are no north-facing single aspect homes.

Total units:	266
LHDG definition Dual Aspect units:	123
All Dual and Enhanced aspect units:	160
Ratio:	60%

Key

- Dual Aspect
- Enhanced Aspect

LHDG DUAL ASPECT DEFINITION

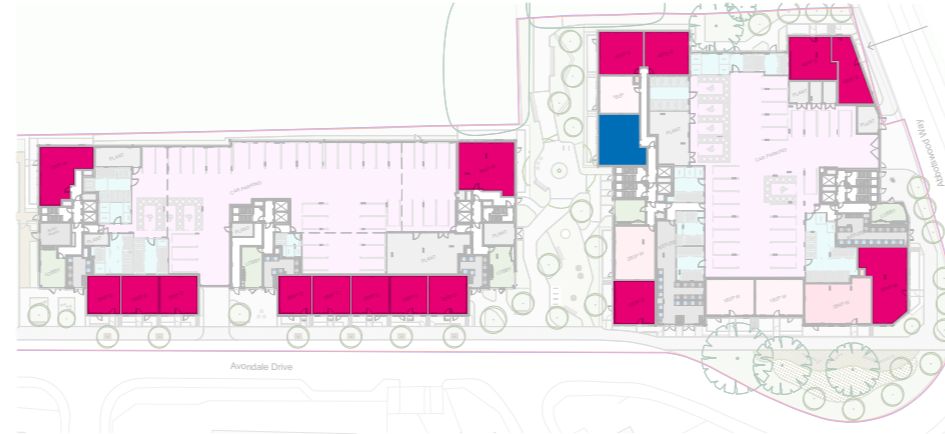
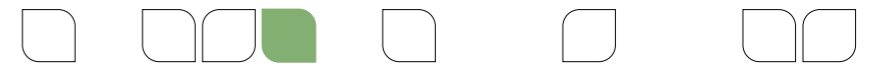
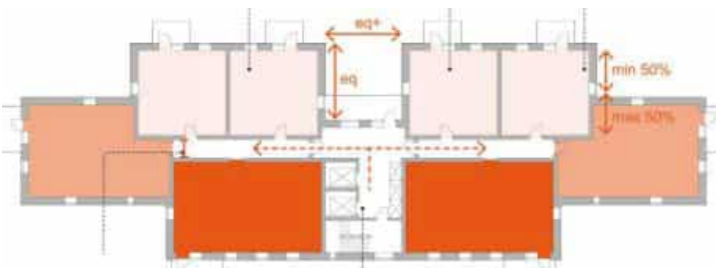

Ground Floor - 17 units



First Floor - 17 units

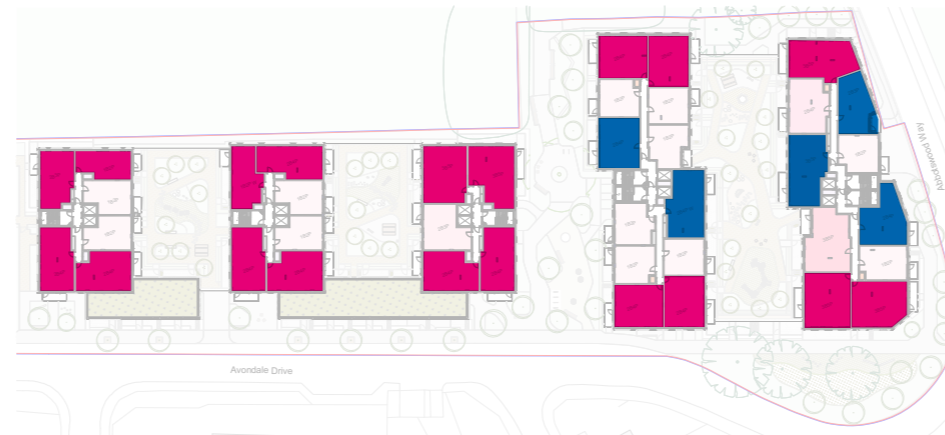

Typical Floor (Levels 2-5) - 24 units per floor

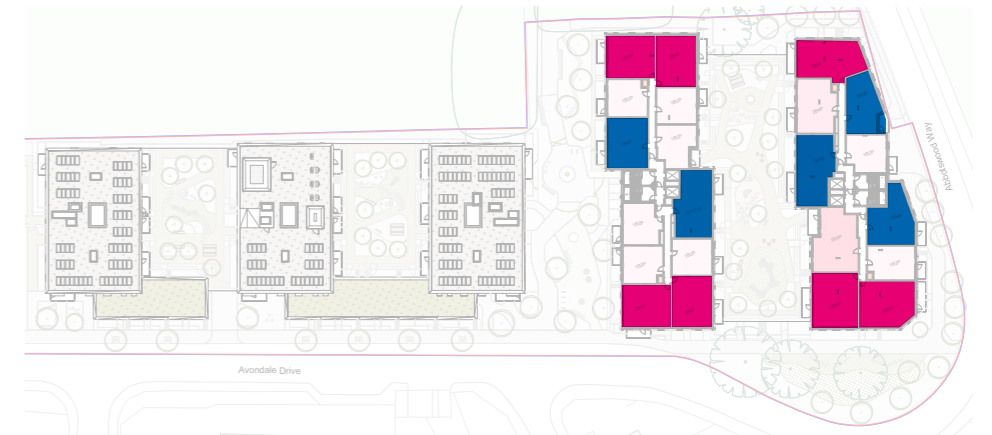

Sixth Floor - 12 units

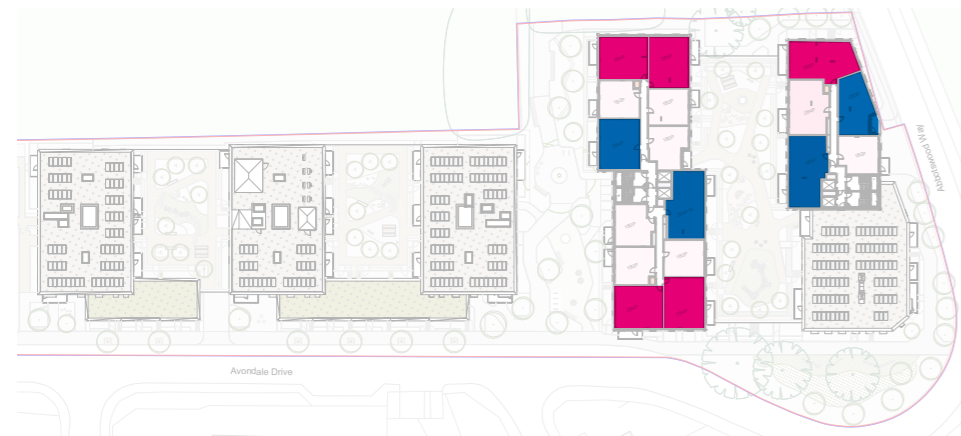

Seventh Floor - 9 units

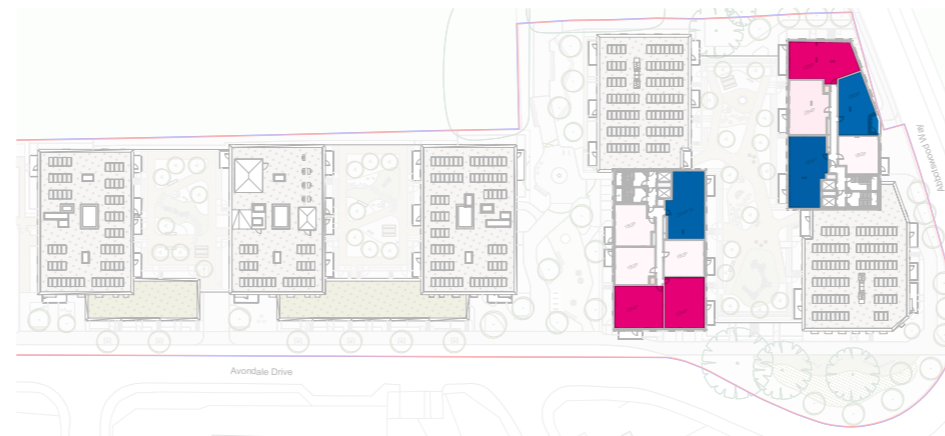

Eighth Floor - 6 units

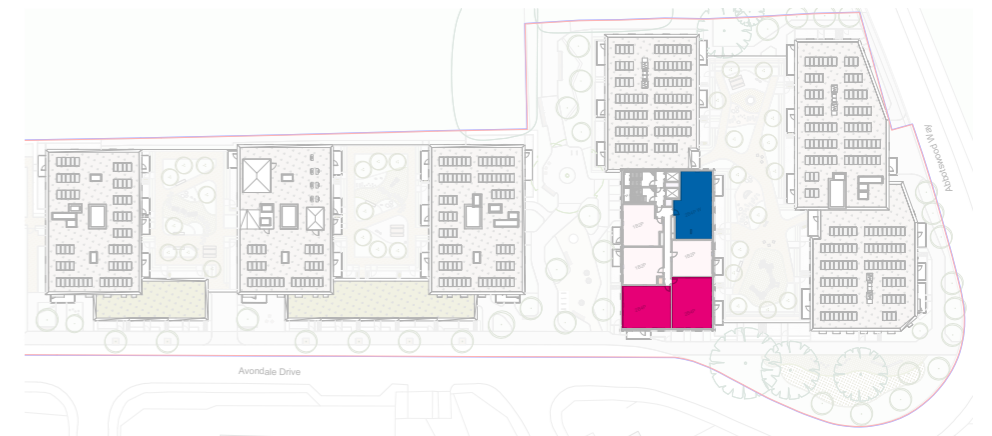

Ninth Floor - 3 units

4.16 PHASE 2 - ROOF PLAN

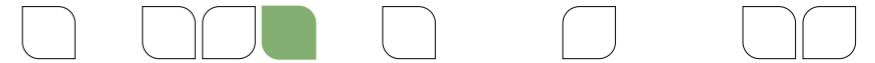

The Phase 2 roof plan sets out the rooftop strategy, demonstrating a strong commitment to sustainability and biodiversity. It shows extensive brown roofs to support local ecology, integrated photovoltaic (PV) panels to offset the building's energy demand, and the block's air source heat pumps (ASHP) located at roof level to preserve active ground floor frontages. Roof access and servicing provisions have also been incorporated to allow safe maintenance of PV and plant equipment.

Green roofs are proposed on the roofs of the duplexes, further enhancing biodiversity and sustainability.

For more information on roof access and maintenance, please refer to section 7.7 under chapter 7 - Technical Considerations.

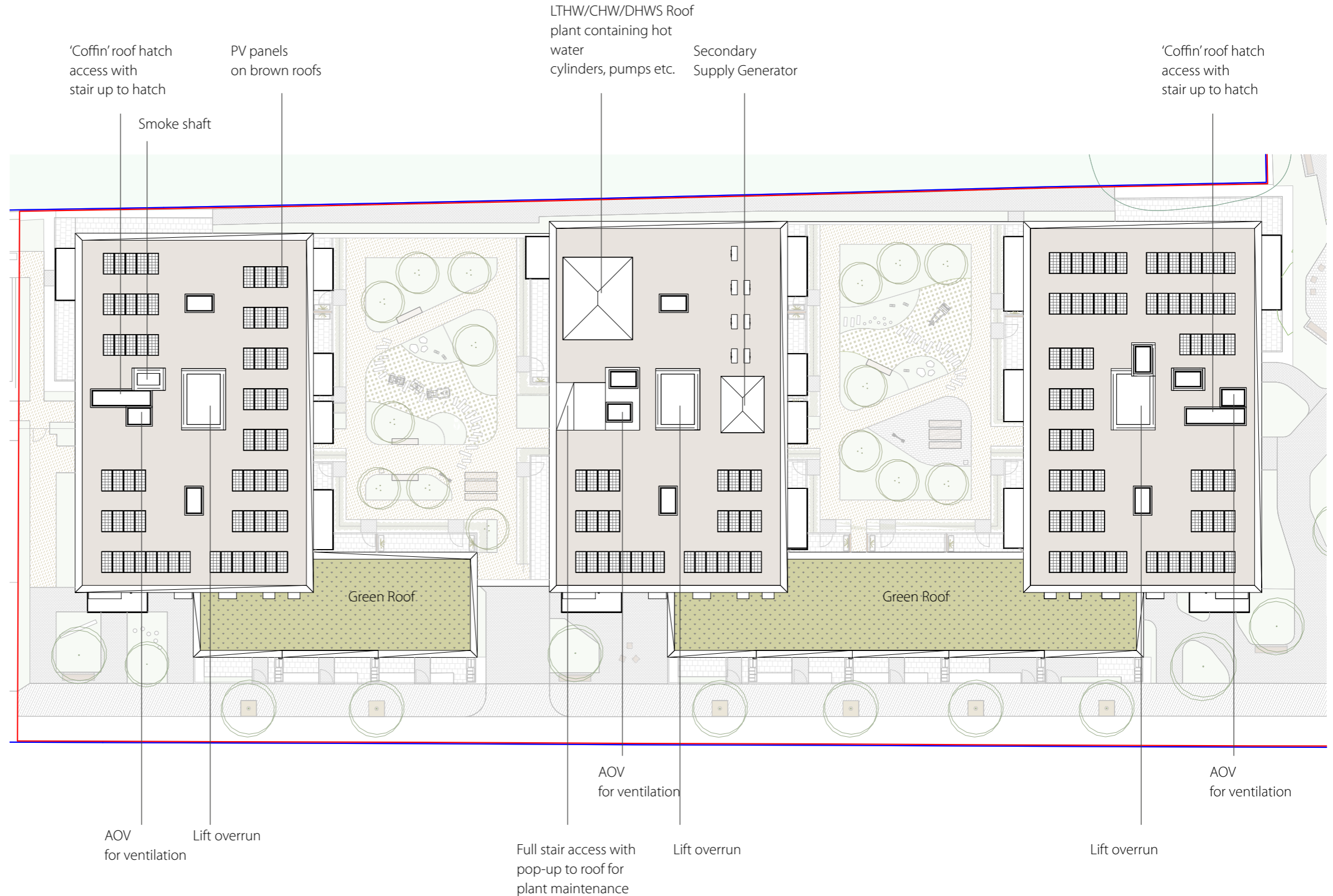

— Outline Planning Application red line (context only)
 — Reserved Matters Application red line

- A / 019
- A / 021-22
- A / 024
- M / 018
- M / 023

4.17 PHASE 1B - ROOF PLAN

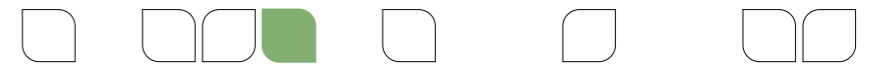

The Phase 1B roof plan sets out the rooftop strategy, demonstrating a strong commitment to sustainability and biodiversity. It shows extensive brown roofs to support local ecology, integrated photovoltaic (PV) panels to offset the building's energy demand, and the block's air source heat pumps (ASHP) located at roof level to preserve active ground floor frontages. Roof access and servicing provisions have also been incorporated to allow safe maintenance of PV and plant equipment.

For more information on roof access and maintenance, please refer to section 7.7 under chapter 7 - Technical Considerations.

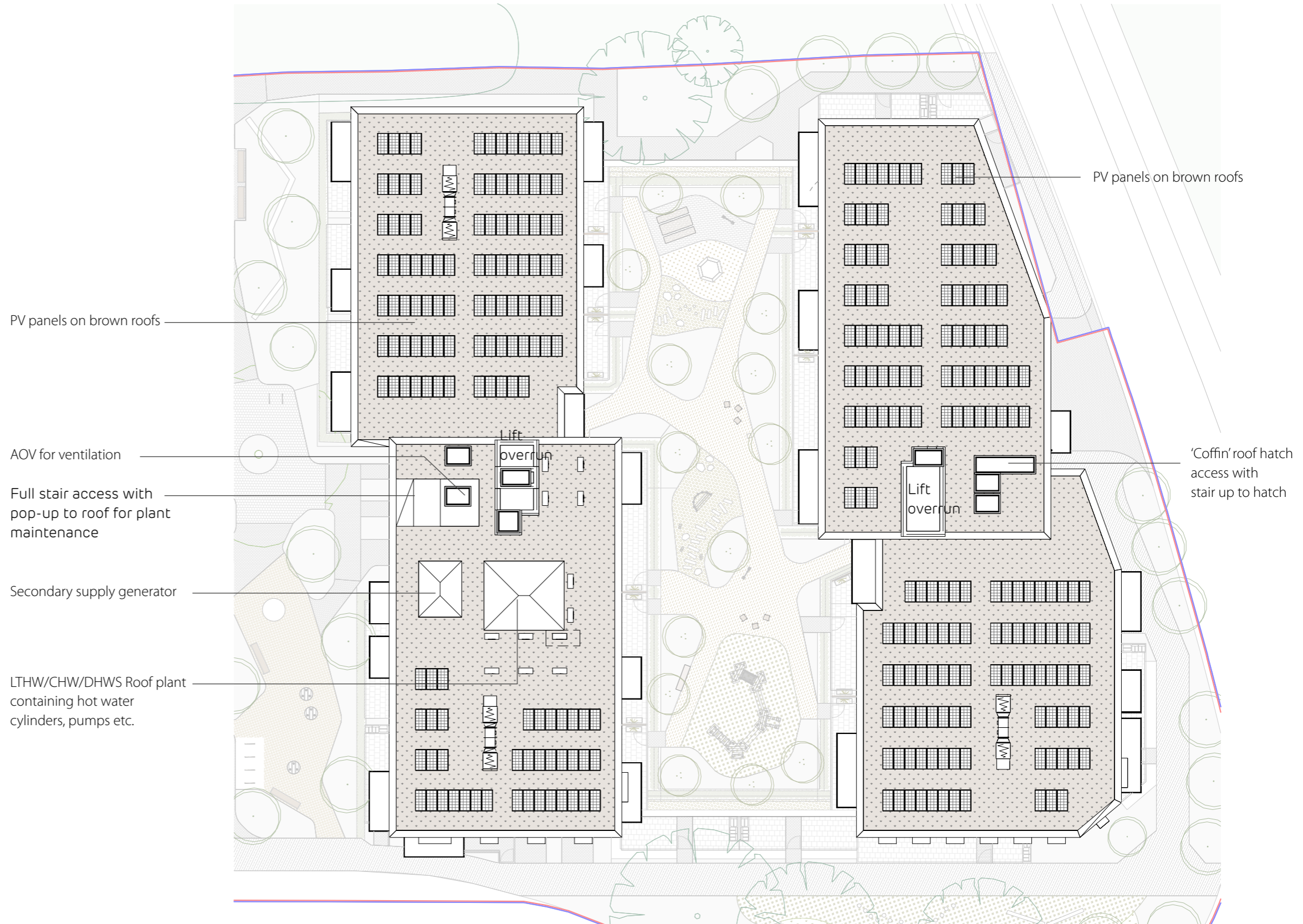

- Outline Planning Application red line (context only)
- Reserved Matters Application red line

A / 019

A / 021-22

A / 024

M / 018

M / 023

4.18 TYPICAL LAYOUTS

4.18.1 4 Bed Duplex

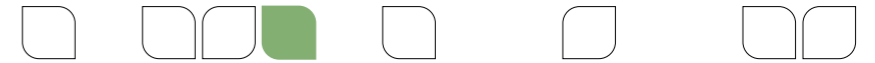

A / 076-80

M / 072

M / 074-75

M / 081

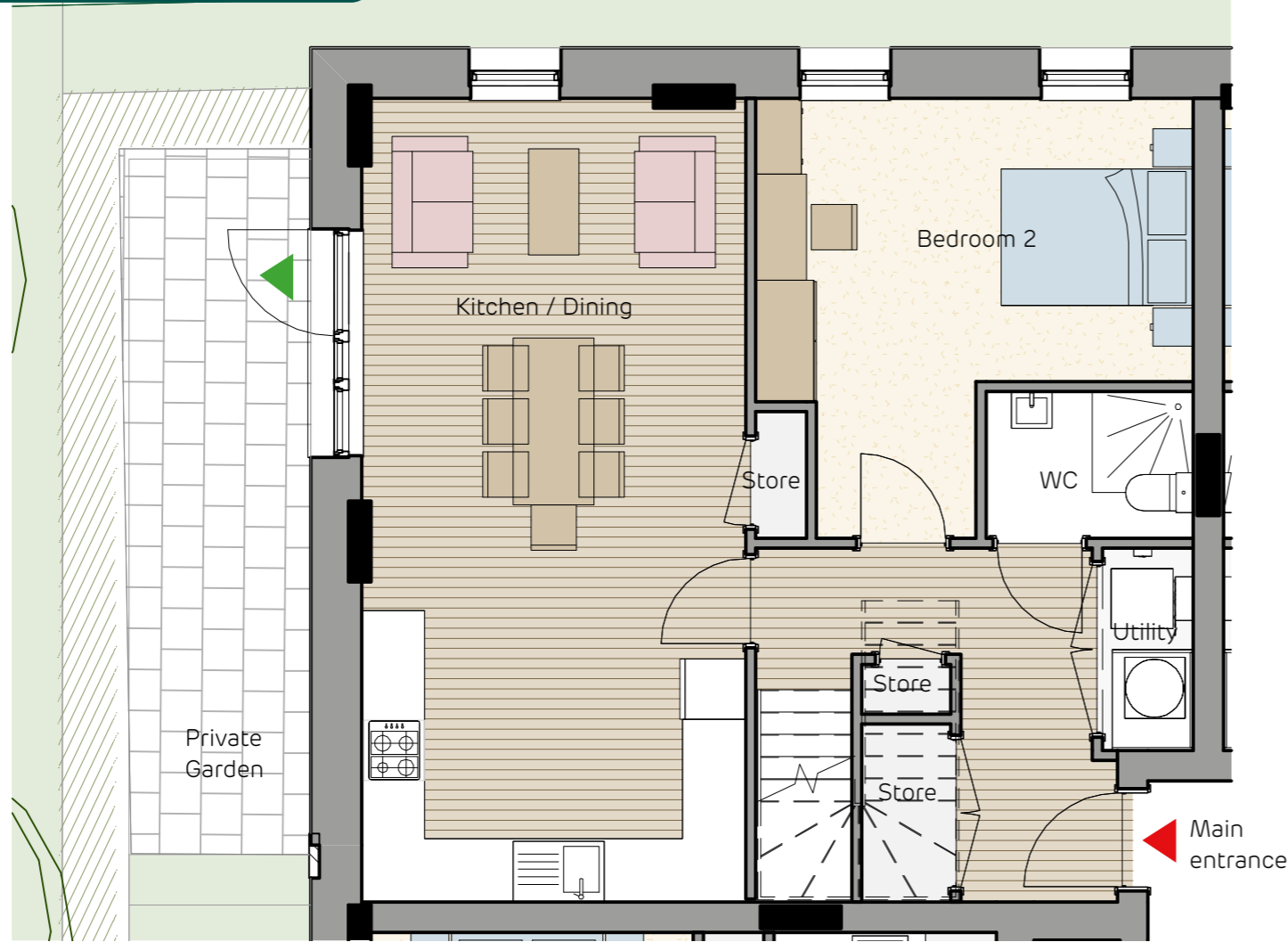

GROUND FLOOR



FIRST FLOOR

TYPICAL LAYOUTS

4.18.2 3 Bed Duplex

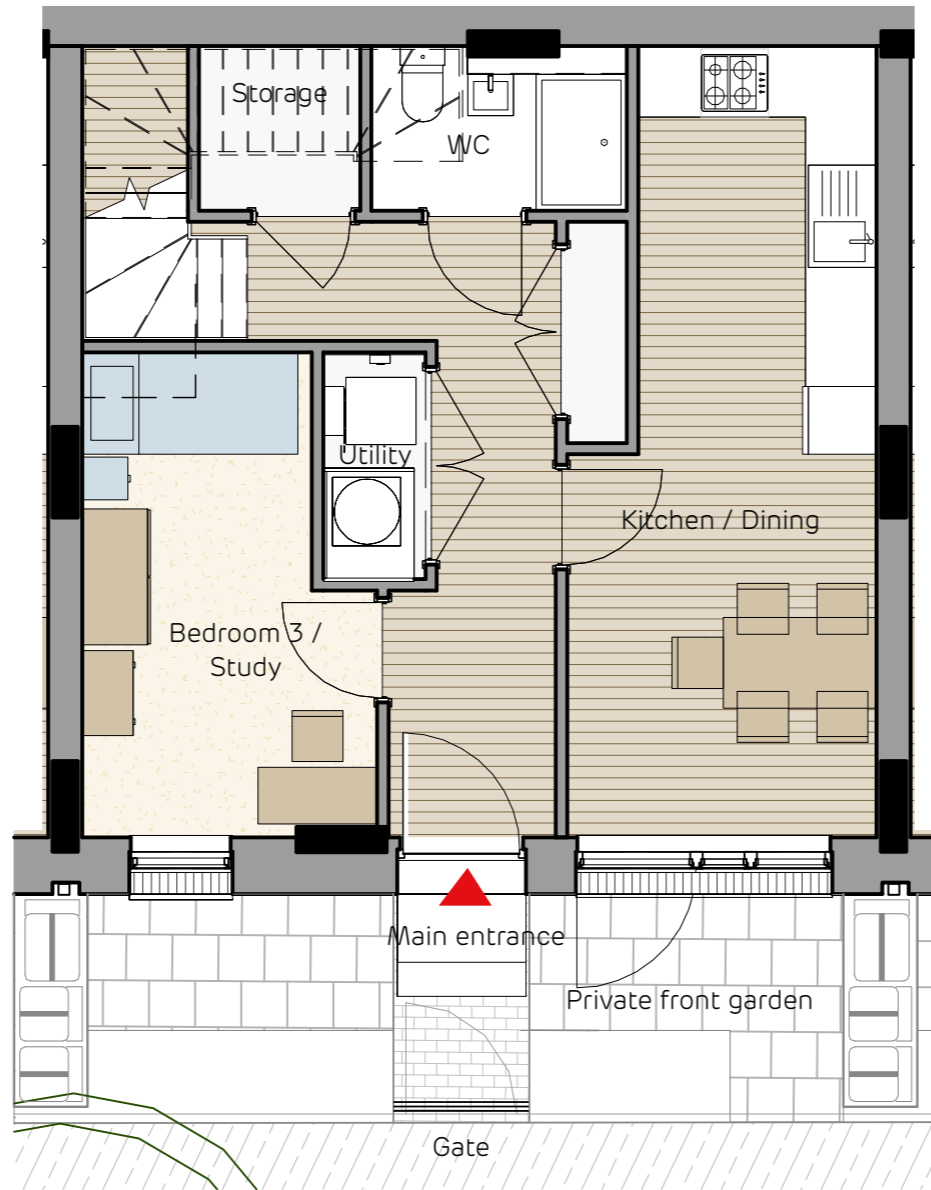
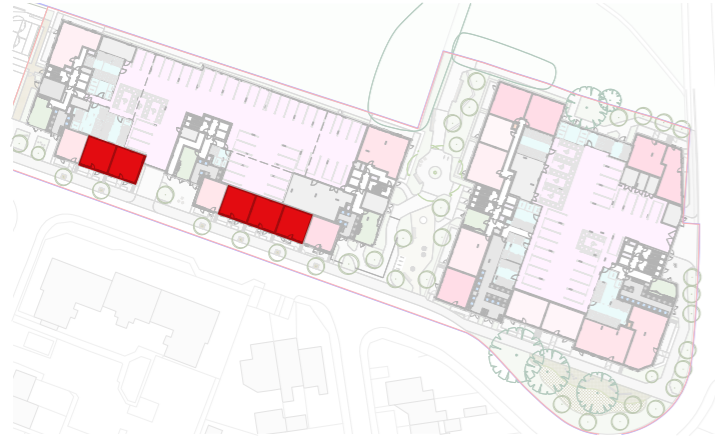

GROUND FLOOR



Access to communal podium garden

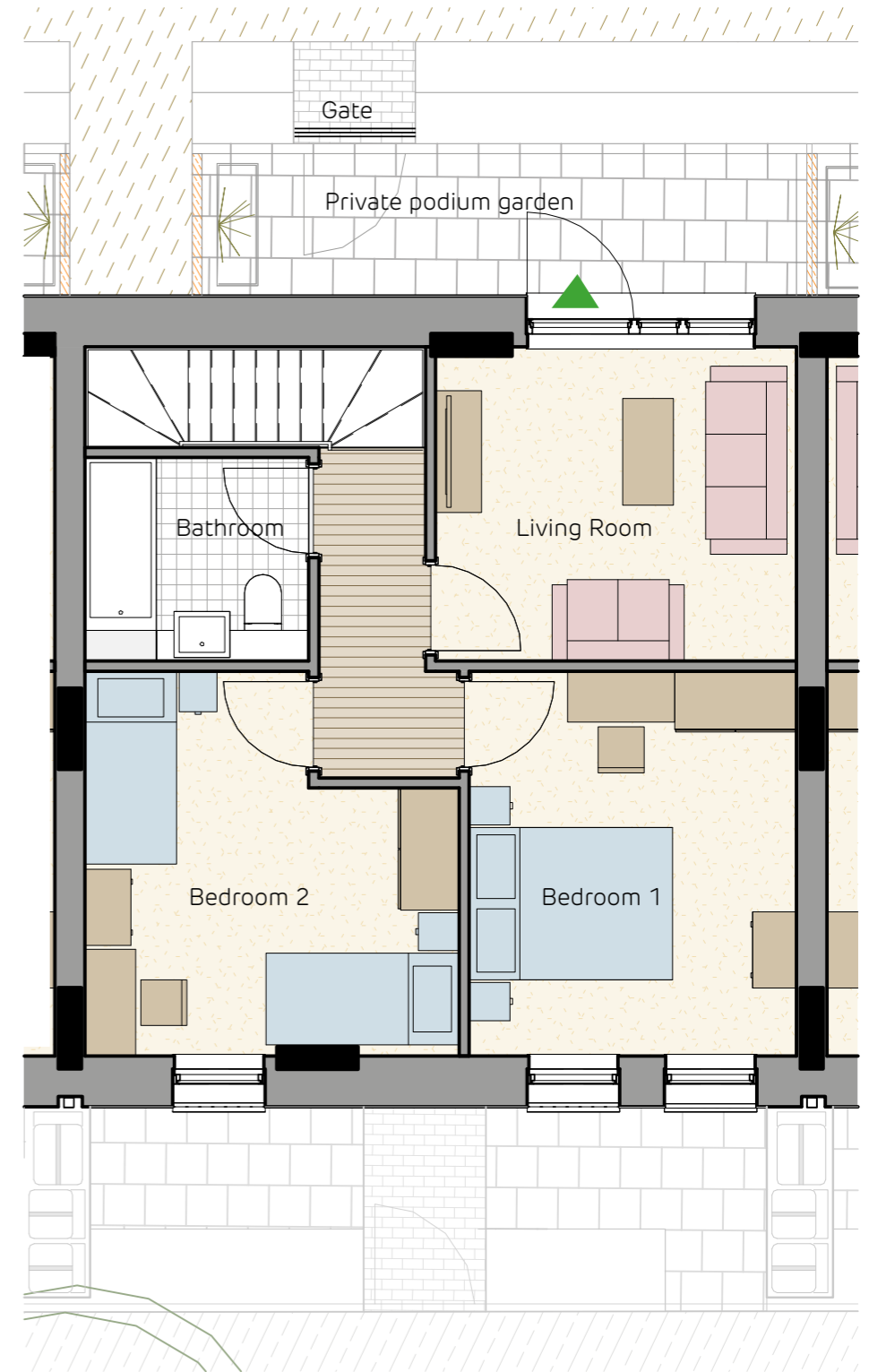

FIRST FLOOR

A / 076-80

M / 072

M / 074-75

M / 081

M / 242

TYPICAL LAYOUTS

4.18.3 2 Bed Duplex

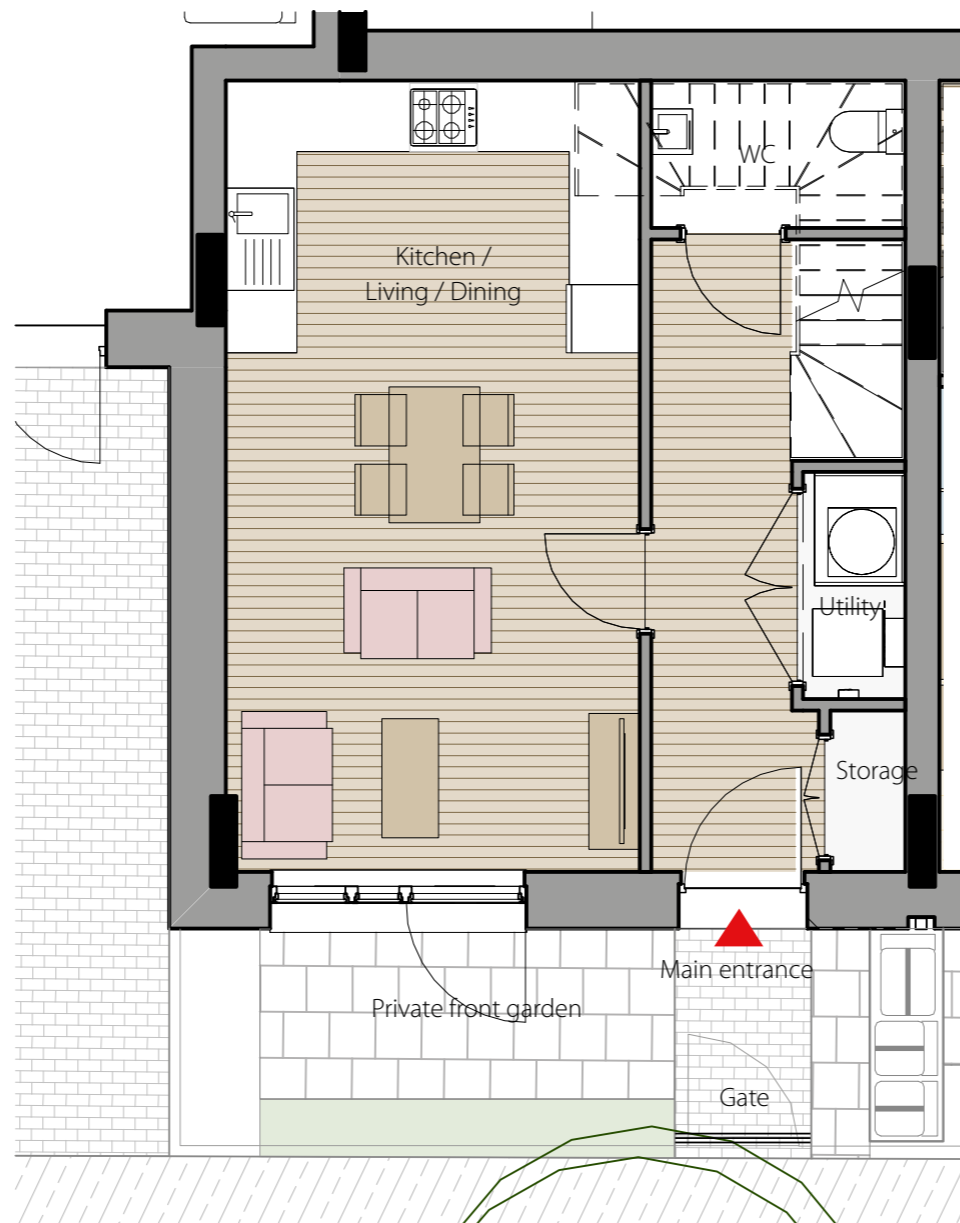
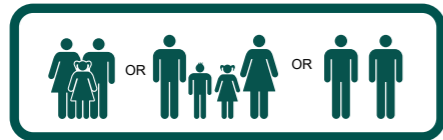

GROUND FLOOR

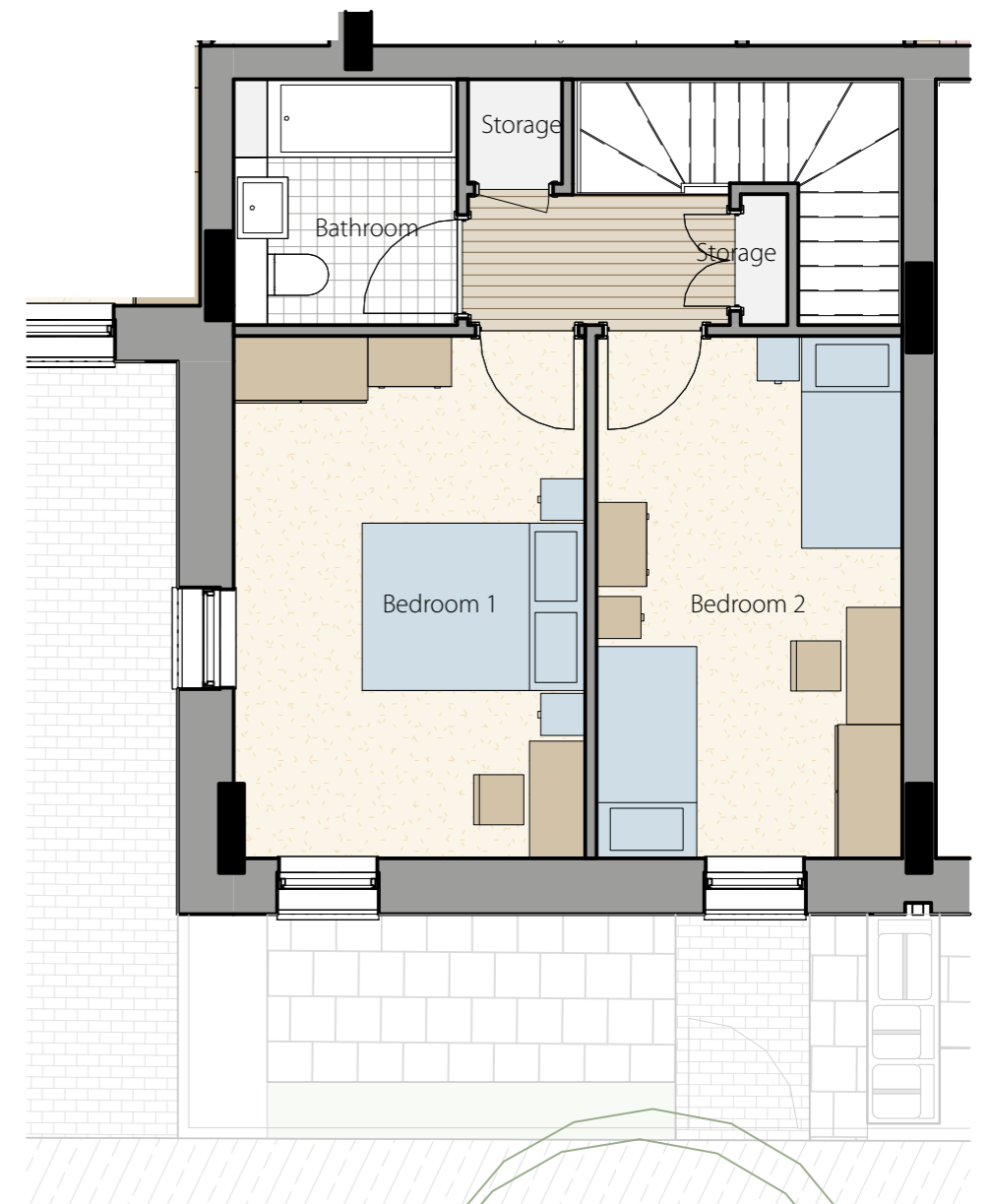

FIRST FLOOR

A / 076-80

M / 072

M / 074-75

M / 081

M / 242

TYPICAL LAYOUTS

4.18.4 3 Bed Flat

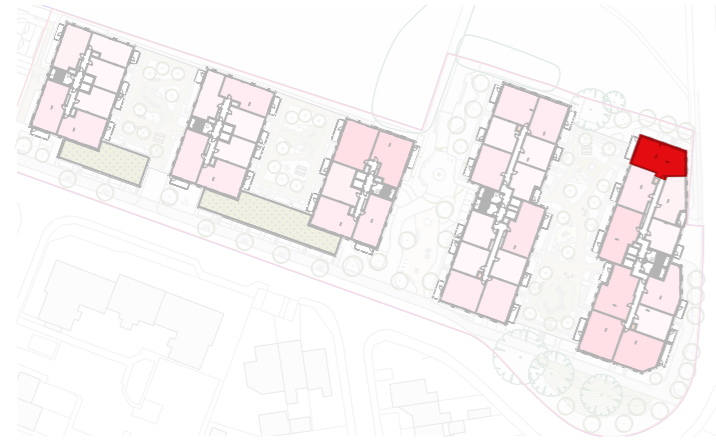
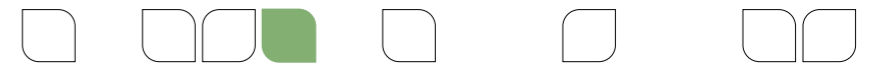

Flexible to have open plan or separate kitchen

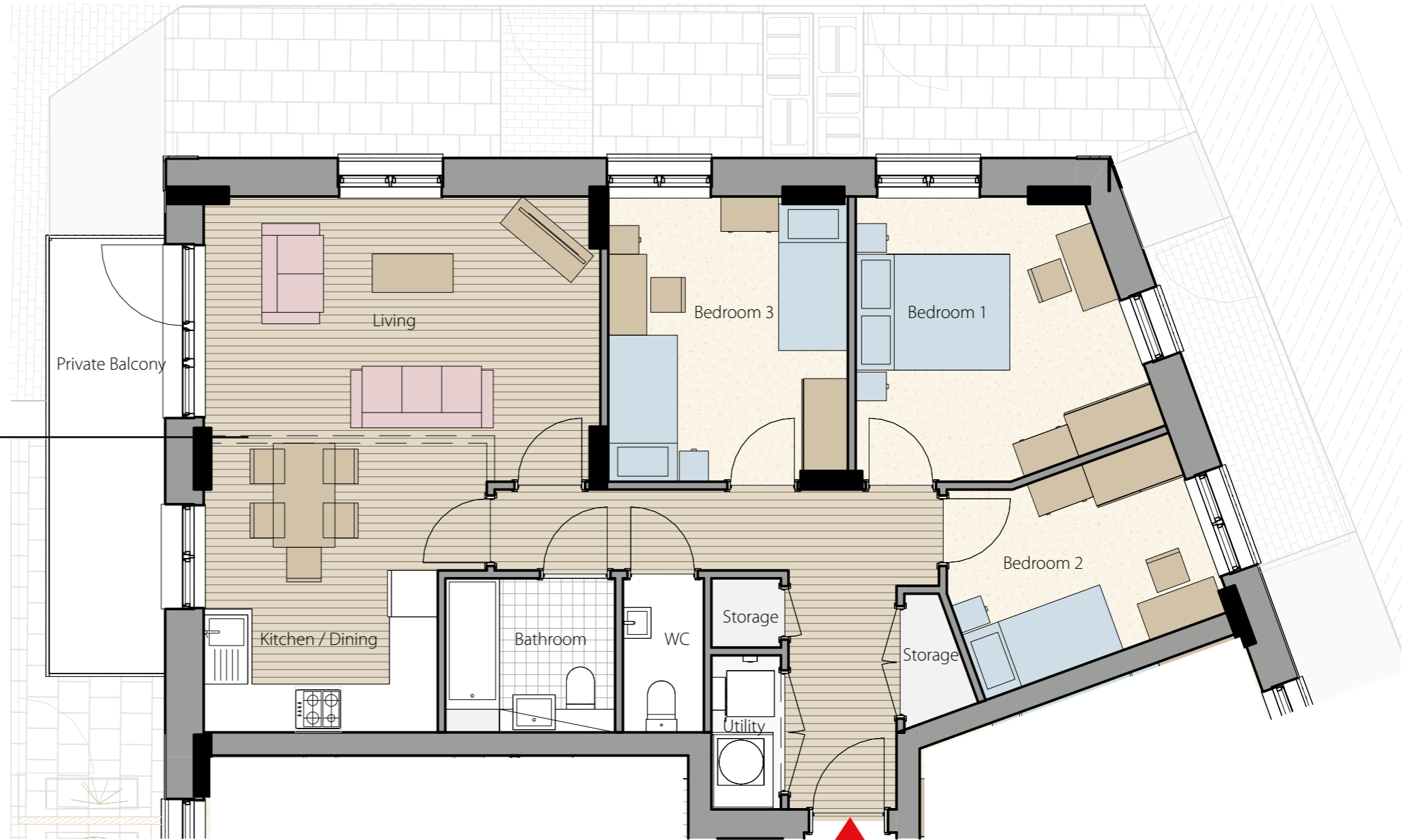

3 BEDROOM FLAT

A / 076-80

M / 072

M / 074-75

M / 081

TYPICAL LAYOUTS

4.18.5 3 Bed Flat Alternative

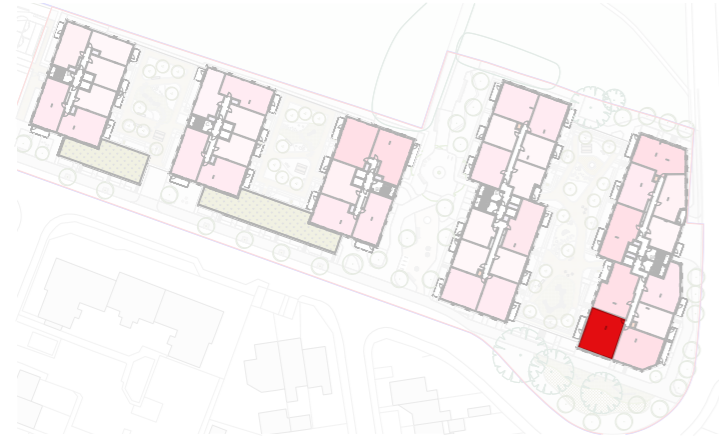
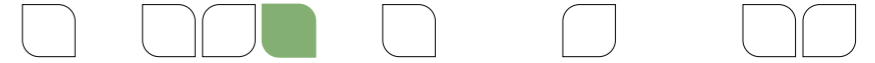

Flexible to have open plan or separate kitchen

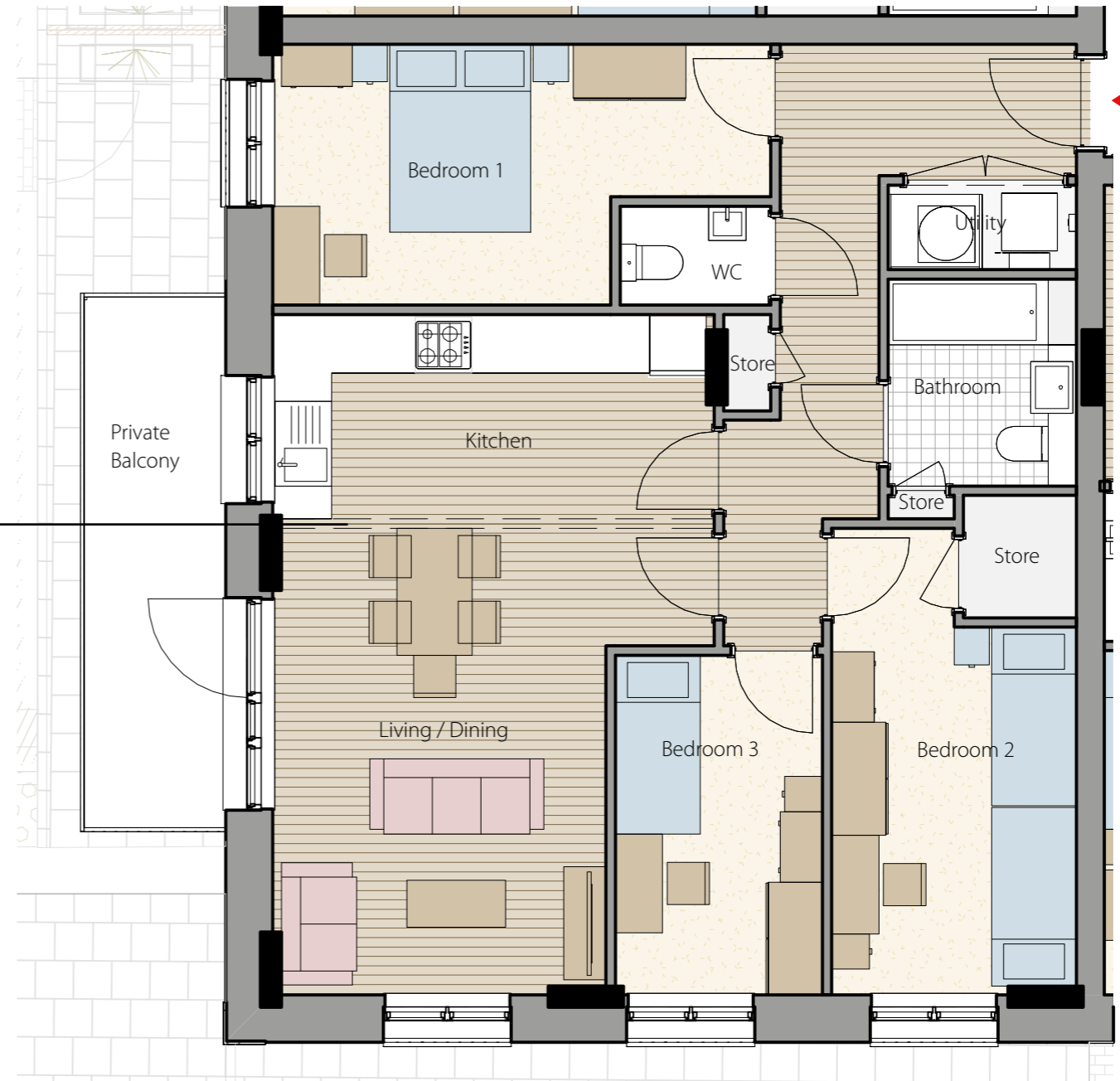

3 BEDROOM FLAT

A / 076-80

M / 072

M / 074-75

M / 081

TYPICAL LAYOUTS

4.18.6 1 and 2 Bed Flats

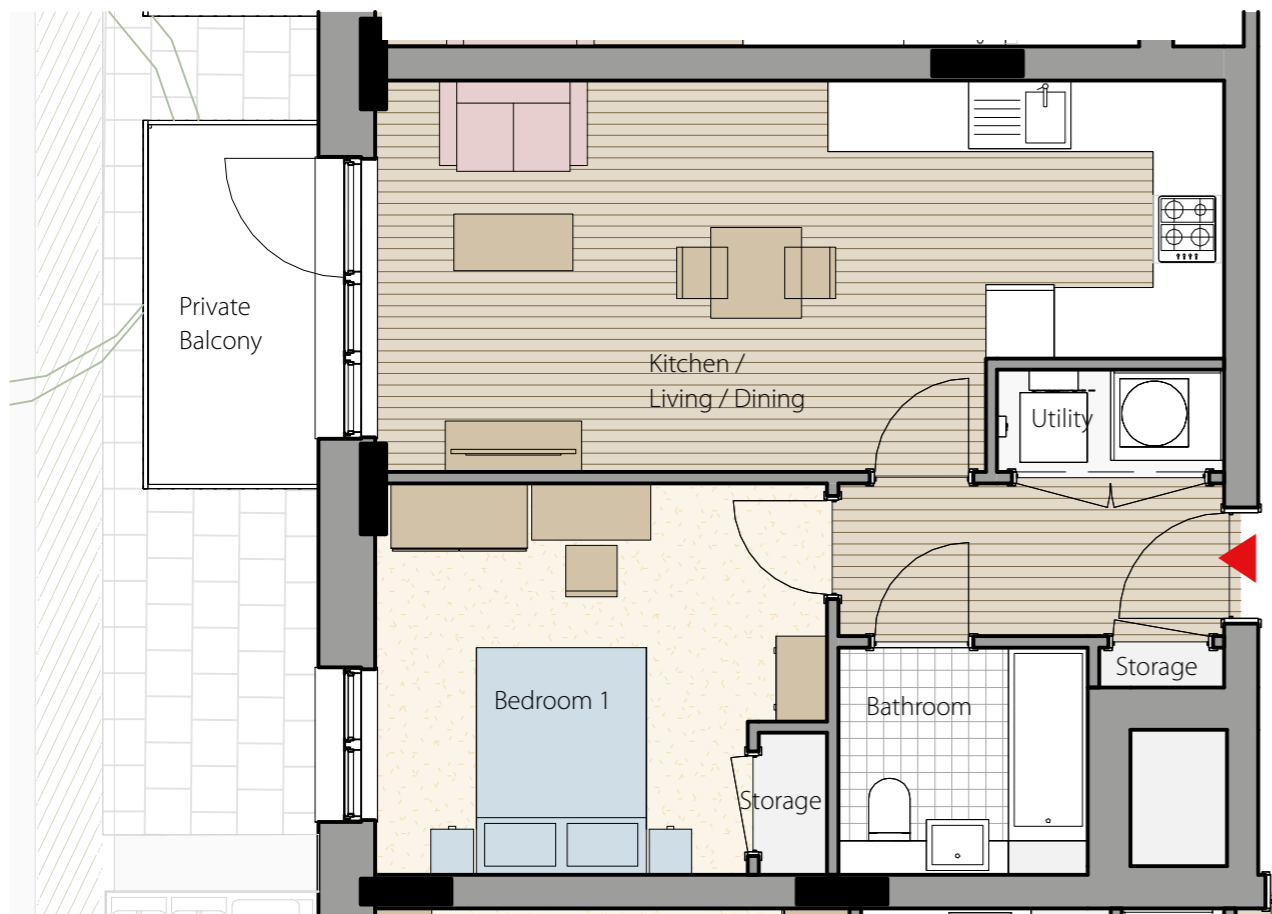
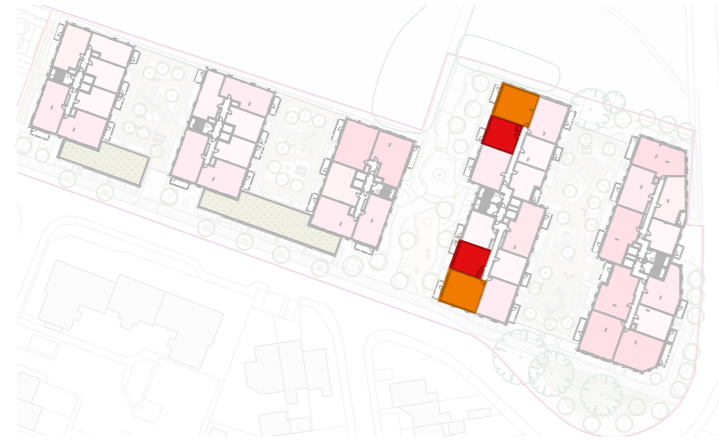
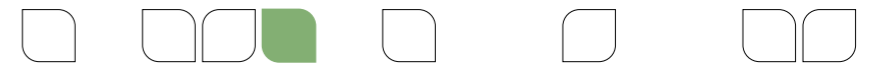

1 BEDROOM FLAT

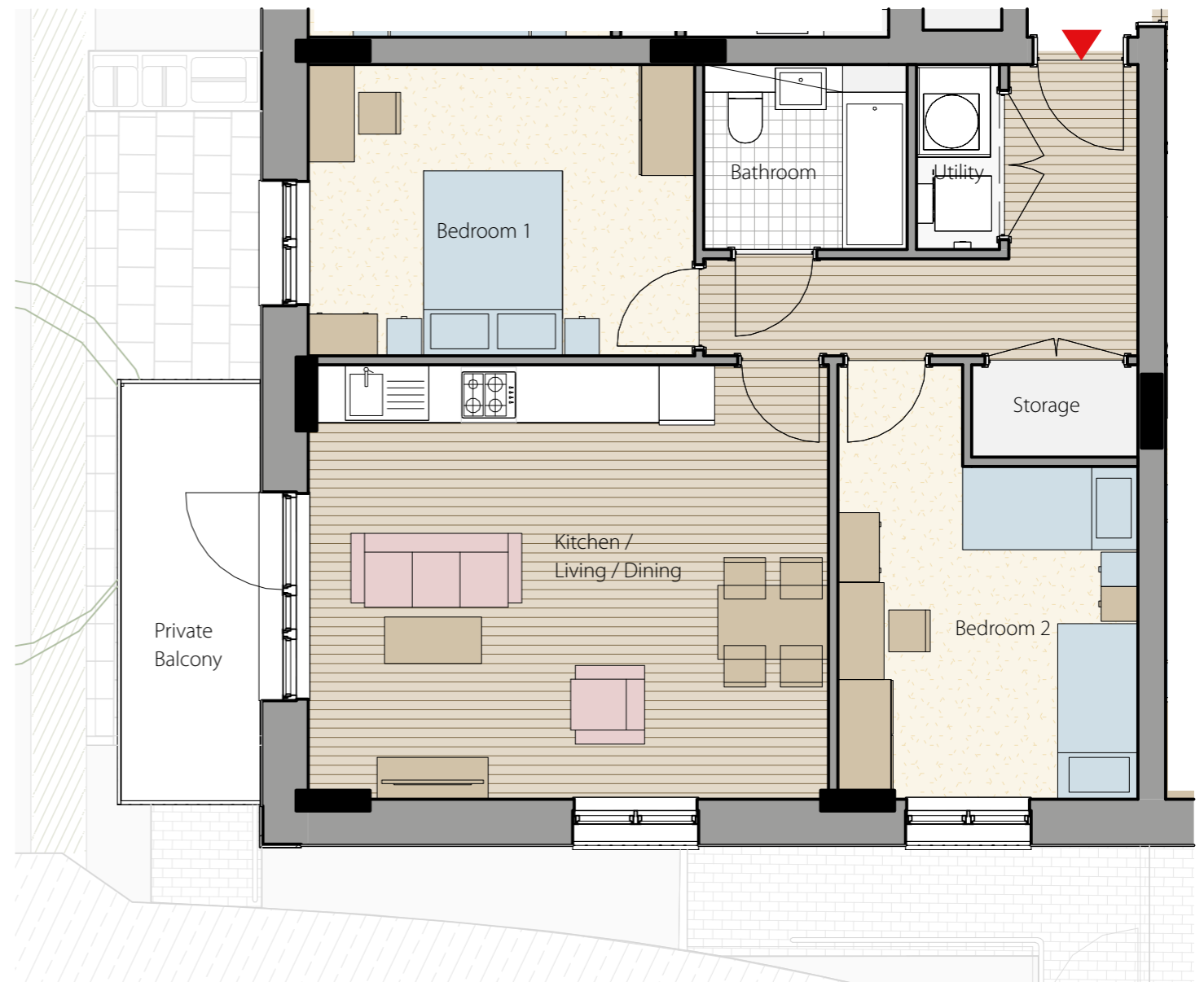

2 BEDROOM FLAT

A / 076-80

M / 072

M / 074-75

M / 081

4.19 INCLUSIVE DESIGN

4.19.1 Inclusive design principles

The proposals adopt a comprehensive approach to inclusive design, integrating accessible homes throughout the development in line with Approved Document M and the London Plan. 10% of homes are designed to M4(3) (wheelchair user dwellings), with the rest meeting M4(2) (accessible and adaptable) standards. These units are distributed across tenures and phases to promote tenure blind design and social inclusion.

Design principles:

- Compliance: All M4(3) homes comply with the standard and have been coordinated with the fire and building services strategies to ensure safe, practical use in everyday living and during emergency evacuation.
- Location and access: M4(3) units are provided at ground floor where possible; additional M4(3) units are served by level lift access to upper floors. Continuous step free routes link accessible homes to entrances, cores, communal amenity, parking and public transport.
- Tenure blind design: Accessible homes are equivalent in finish and external expression to other dwellings, ensuring no architectural hierarchy between tenures.

Private and communal amenity

- Private amenity (gardens, terraces and balconies) associated with accessible homes are designed for step free access, level thresholds and suitable slip resistant finishes.
- Communal amenity, courtyards and podium gardens provide level access routes, a range of seating heights and accessible play/fitness elements where applicable.

Parking and servicing

- Accessible parking bays are provided in accordance with policy standards, with capacity to convert the standard parking spaces into further accessible spaces in the future if required.
- Delivery, refuse and servicing arrangements allow step free access to bin and cycle stores and avoid obstacles on primary routes.

Fire safety and evacuation

- Accessible layouts have been coordinated with the Approved Outline Fire Safety Strategy to ensure compatibility with the chosen evacuation approach and fire-fighting arrangements. Where relevant, refuge areas and evacuation lifts are provided in accordance with guidance and regulations.

KEY

- 1 Bed Accessible WCH unit
- 2 Bed Accessible WCH unit
- 3 Bed Accessible WCH unit
- Accessible parking spaces

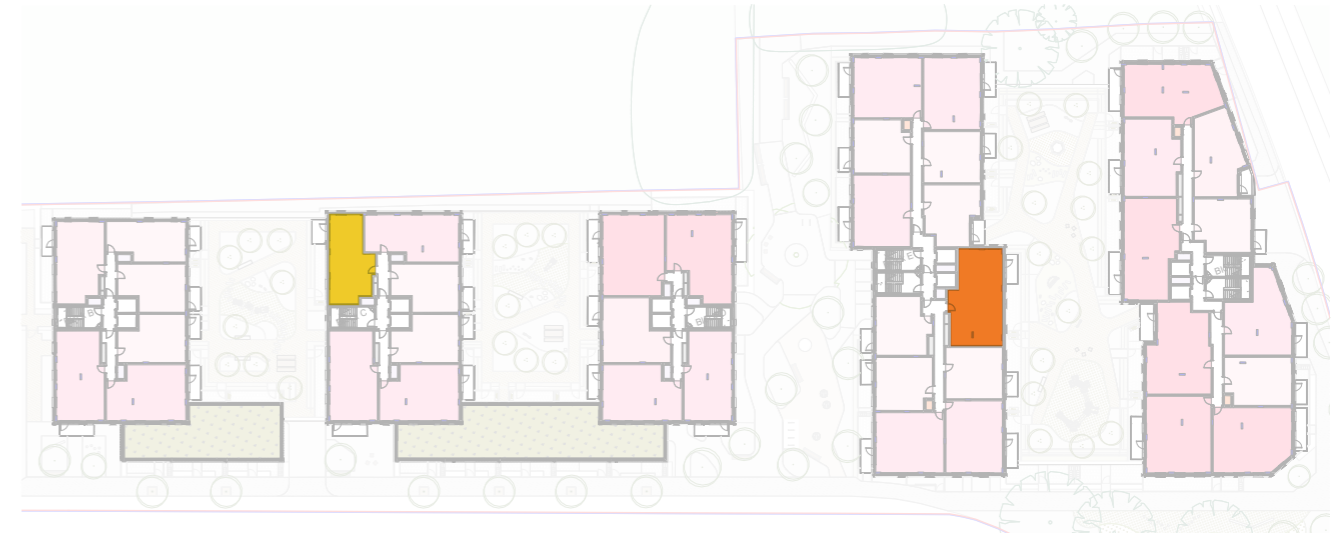

TYPICAL FLOOR PLAN

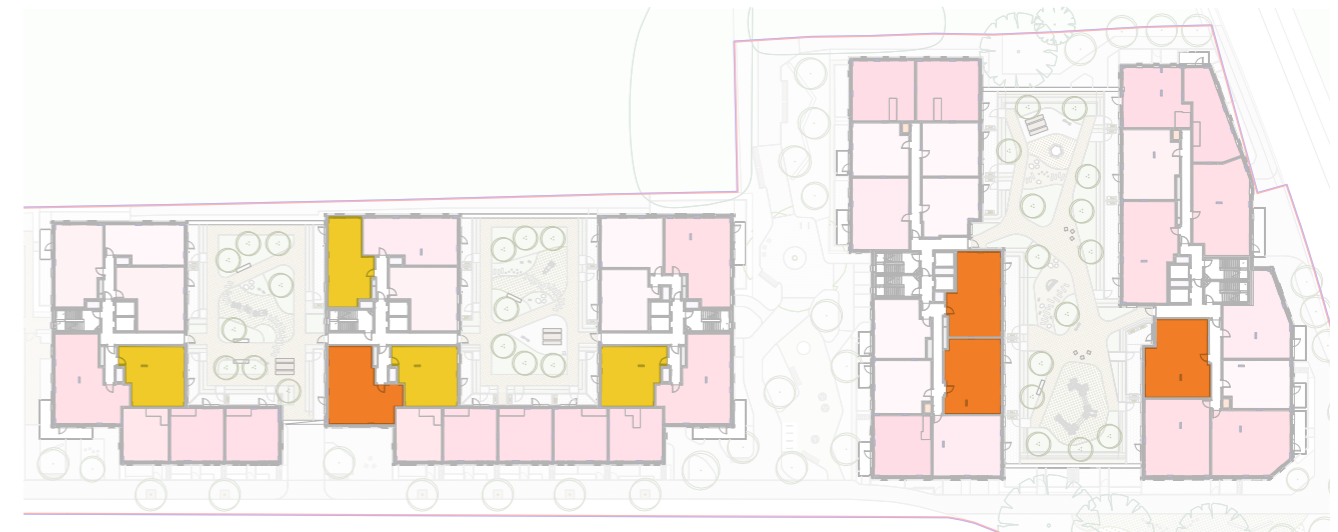

FIRST FLOOR PLAN

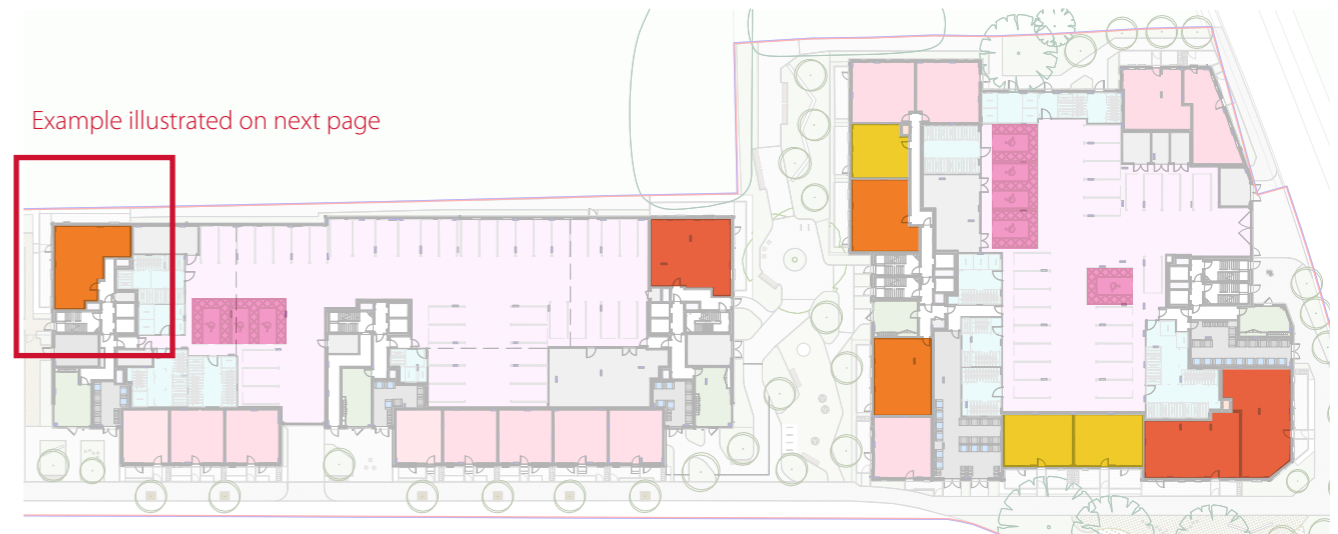

GROUND FLOOR PLAN

A / 091

M / 090

M / 095

INCLUSIVE DESIGN

4.19.2 Accessible flat layouts

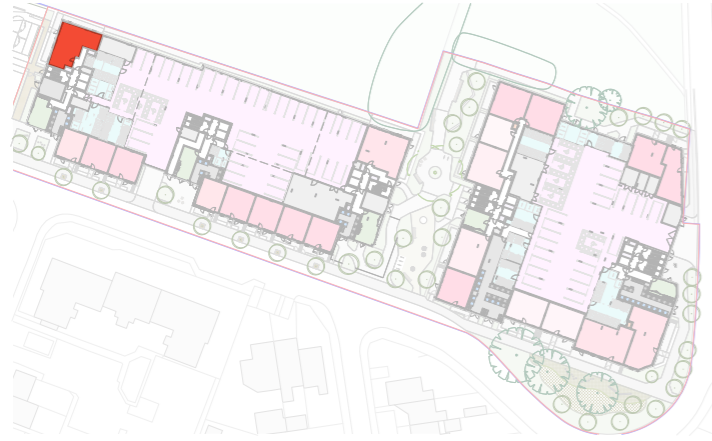

Internal layout and dimensions

- Entrances and circulation: Principal entrance doors provide a minimum clear opening of 850 mm. Hallways and principal routes maintain a minimum clear width of 1,200 mm to enable manoeuvring and access.
- Turning and transfer: A 1,500 mm clear turning circle is provided where required. Dedicated transfer and storage zones of 1,100 x 1,700 mm are incorporated adjacent to entrances.
- Living and sleeping spaces: Living/kitchen/dining areas allow 1,500 mm clear access zones in front of key units and appliances. Principal double bedrooms meet minimum size and circulation requirements to permit bedside access and manoeuvring.
- Bathrooms: M4(3) dwellings include level access showers and layouts that facilitate side and end transfers. Sanitary arrangements allow for clear manoeuvring spaces (for example 1,200 x 800 mm or equivalent as appropriate).
- Kitchens: A minimum 1,500 mm clear access zone is provided in front of and between kitchen units and appliances to enable comfortable use by wheelchair users.

A typical M4(3) 2B/3P ground floor layout is included to the right, illustrating how the proposed accessible dwellings achieve high quality, practical homes for wheelchair users.

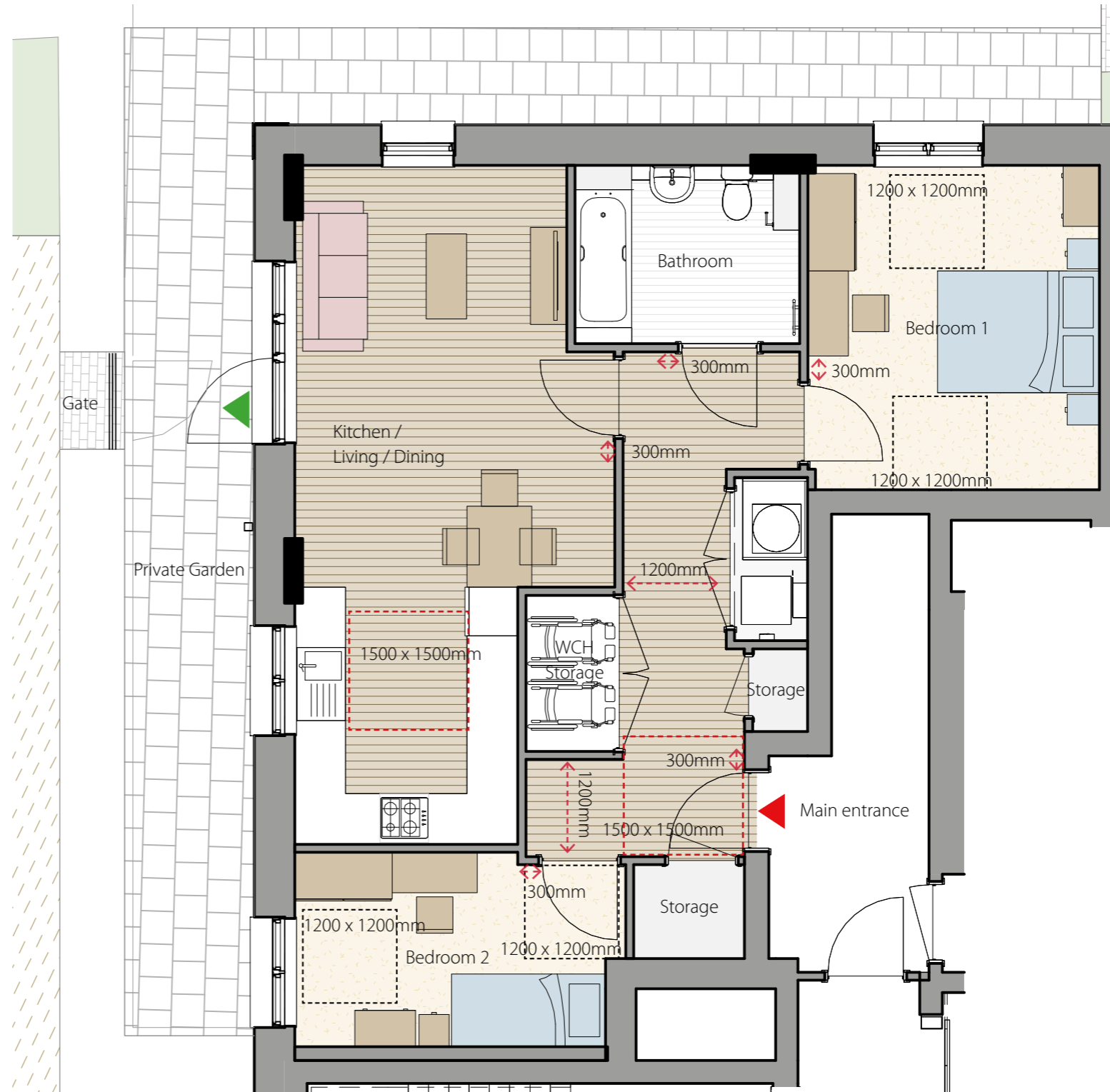

PROPOSED TYPICAL LAYOUT - GROUND FLOOR WCH FLAT

A / 076-80
A / 091

M / 072
M / 074-75
M / 081
M / 090
M / 095

4.20 PRIVATE AMENITY AND DEFENSIBLE SPACE

4.20.1 Site-wide strategy

Private Amenity

Every single home will be provided with at least one form of private external amenity space in accordance with the below:

- All ground floor flats will have private gardens at ground floor level. These will have a dual function to also act as defensible space and improve privacy by mitigating overlooking into the ground floor flats.
- All ground floor duplexes will have private gardens on ground floor; some of them will have additional private garden on first floor podium; some of them will have projecting balcony on first floor. Likely to be occupied by more people, the multiple forms of amenity to the larger dwellings offers variety.
- All apartments on upper levels will have projecting balconies as their private amenity spaces. These have been positioned with consideration in regards to overlooking and to help mitigate overheating.



All amenity spaces are sized according to the number of bedspaces of the dwelling it serves, in accordance with requirements stipulated in the Design Code and the London Plan. A minimum of 5sqm of step-free private outside space is provided for each two bedspace home, with an extra 1sqm for every additional bedspace. Each amenity space is a minimum of 1.5m depth and width.

Defensible Space

All frontages between ground floor dwellings and public space, and between first floor dwellings with podium gardens and communal podium space will have a defensible edge, even if not deep enough to be considered amenity space.

This defensible space will include soft landscaping and planting to act as a buffer, protecting the privacy of the residents.

Key - Amenity

-  Ground Floor Garden
-  First Floor Terrace on Podium
-  Projecting Balcony

Key - Home Type

-  Duplex
-  GF WCH Flat

Key - Defensible space

-  Defensible space buffer (not amenity)

Balconies on corners facing south create interest along Avondale Drive and respond to overheating requirements

Corner balconies on the first floor over the entrance lobbies help highlight the entrance and act as canopies whilst also creating an architectural feature

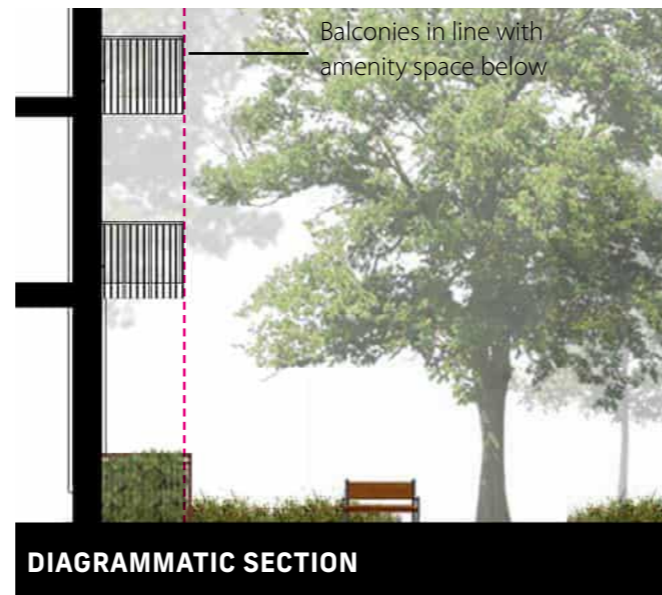

A / 143	A / 153-55		
M / 026-29	M / 032	M / 061	M / 142
M / 144-47	M / 151-52	M / 157-58	M / 248
M / 274	M / 290	M / 298	

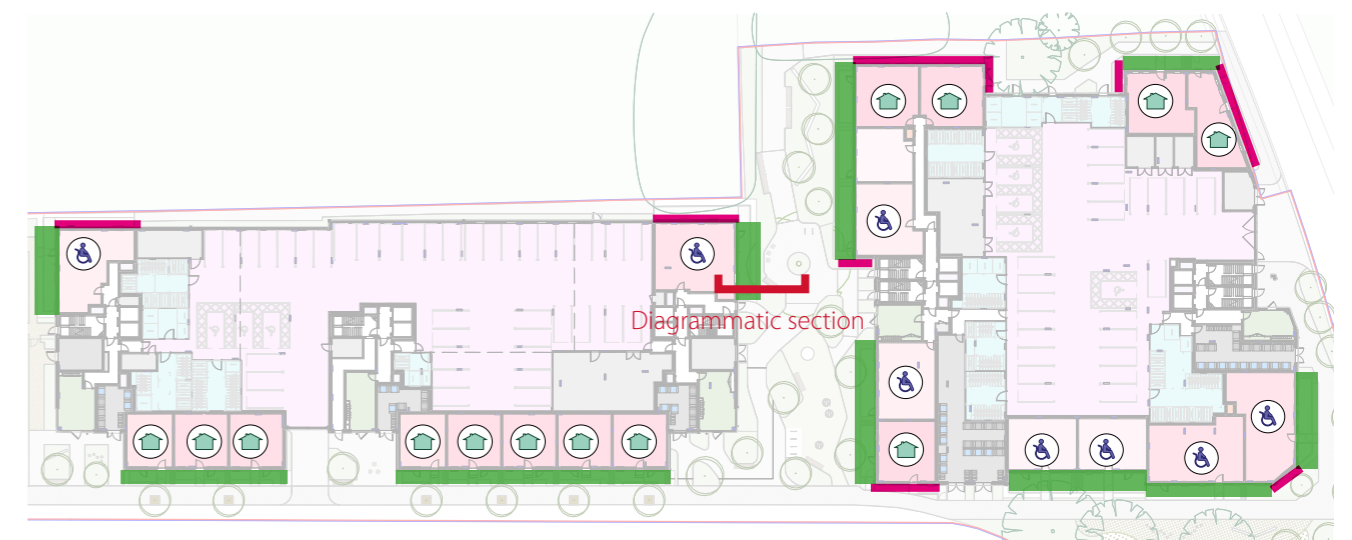
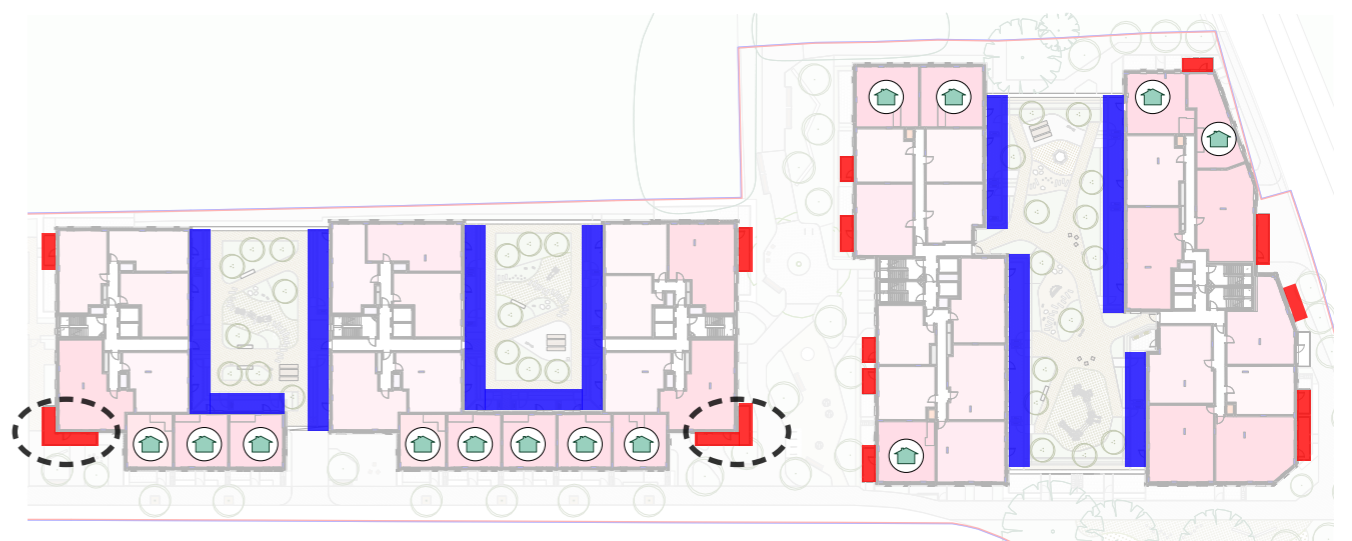
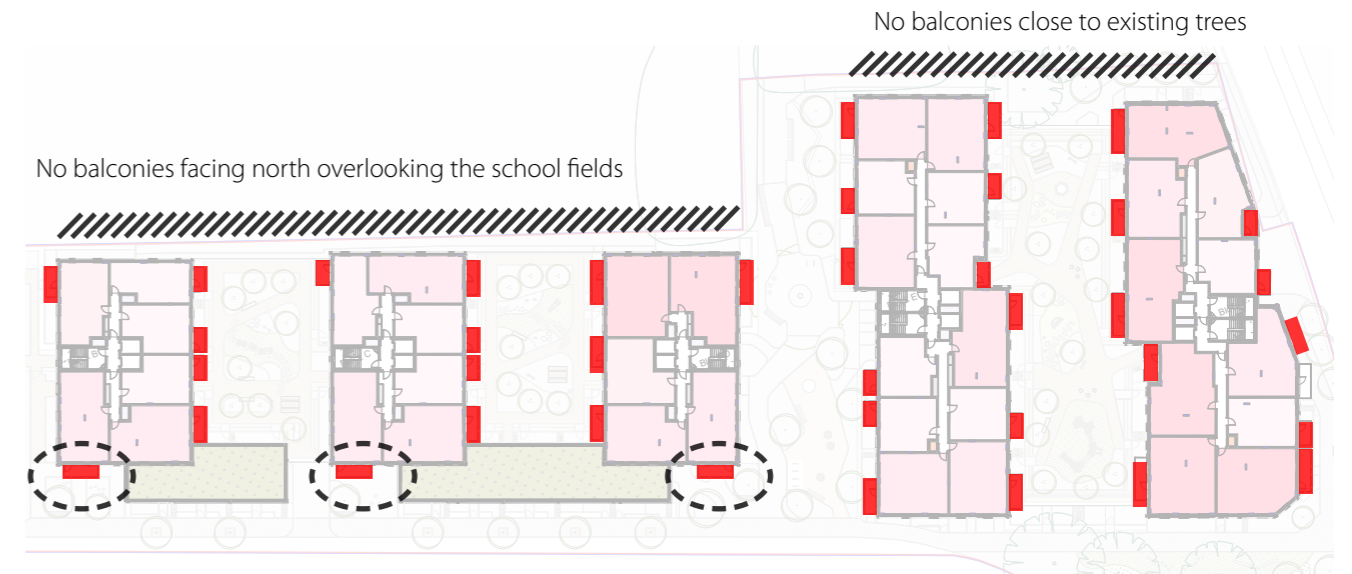
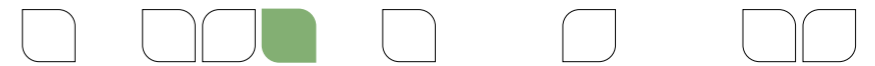

PRIVATE AMENITY AND DEFENSIBLE SPACE

4.20.2 View into landscaped park connection from amenity

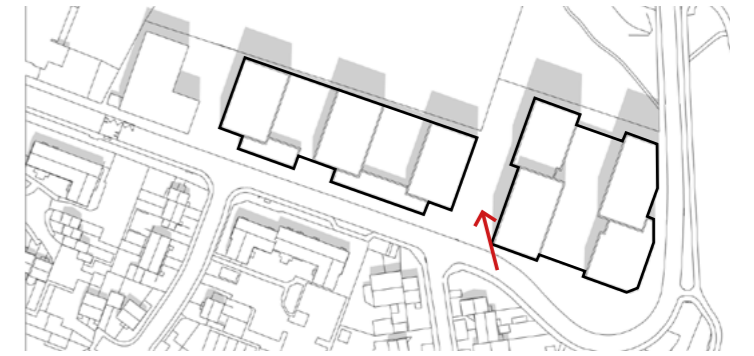
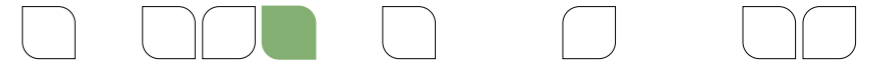

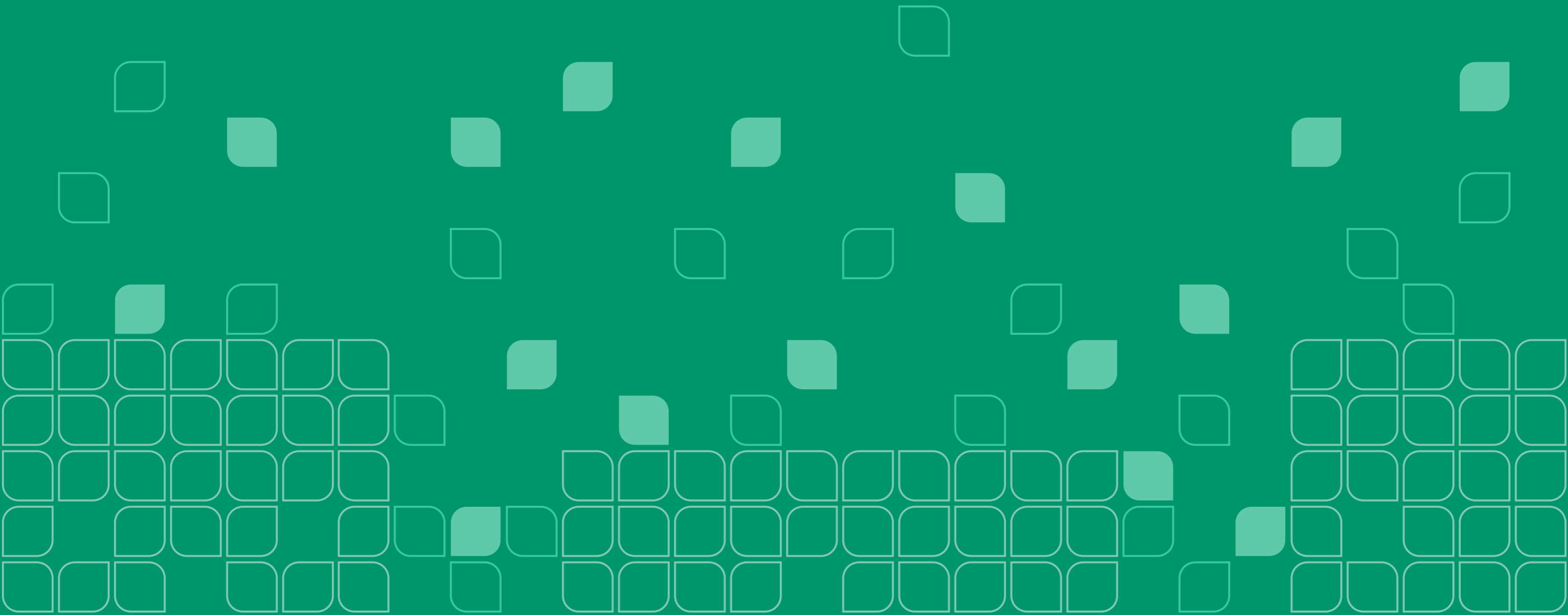

5. LANDSCAPE

5.1 LANDSCAPE STRATEGY

5.1.1 Landscape Masterplan

The Landscape Masterplan follows the principles and layouts set out within the outline scheme. This incorporates the following key areas:

- Street frontage to Avondale Drive and Abbotswood Way; these incorporate tree planting, hedges and private amenity spaces
- Pocket green space connecting Avondale Drive and Abbotswood Way; this area provides play on the way features, set amongst the existing trees. Additional tree and shrub planting is proposed to the roadside.
- Hitherbroom Link; this area of public realm sits between Phases 1B and 2. It includes areas of incidental play, a feature existing Wild Cherry tree, rain gardens and areas of seating.
- Phase 1B Northern Boundary; includes the boundary to the Hitherbroom Park, with enhanced tree planting and a replacement boundary treatment
- Communal gardens; set on the first floor, these include doorstep play features, planting, seating and a varied space for residents to utilise.

BIODIVERSITY STRATEGY

The landscape design has been prepared to provide biodiversity enhancements in accordance with the PEA and ecological consultant recommendations. These include the following principles:

- Tree Planting; extensive tree planting including a variety of species. This includes native species, native cultivars, flowering and fruiting species and cultivars.
- Raised beds; within first floor courtyards all planting is within raised beds. These contains a wide variety of species, including species on the RHS Plants for Pollinators List.
- Insect Hotels; to each first floor courtyard insect hotels are provided and integrate into the landscape. These are designed to provide both ecological and social benefit.
- Nectar rich planting; throughout the scheme large quantities of flowering trees and shrubs alongside herbaceous planting is proposed. A large quantity of planting is from the RHS Plants for Pollinators list.
- Bird boxes; these will be provided as per the ecological recommendations and the outline consent within the detailed design
- External Lighting; the lighting design will ensure the ecological recommendations are followed, with bat sensitive lighting provided to recommended areas.
- Green and Brown roofs; provided to the tops of blocks, green roofs utilise a species rich seed mix, whilst brown roofs are designed for natural colonisation.

The design complies with the open space and public realm designations set out by Parameter Plan 4 of the Outline Planning Permission (as amended).



PARAMETER PLAN 4 - OPEN SPACE AND PUBLIC REALM



M / 122
M / 123
M / 124
M / 126
M / 220
M / 221
A / 128
A / 129

LANDSCAPE STRATEGY

5.1.2 Play Strategy

ACCESS TO EXISTING OPEN SPACE

The outline play strategy plans for play space for 12+ year olds to be met offsite within existing facilities, as these are only 400-800m from the site (as per the Play and Informal Recreation SPG). Play on site is therefore focused on children aged 0 to 11 years.

ON-SITE PROPOSALS

The current proposals are under the GLA policy area requirements, however this follows the outline scheme with no reduction in total area.

The proposals follow the outline strategy of providing doorstep play within the communal spaces, and play on the way features to the public realm to create a child friendly environment for residents and site users.

As per the outline application, the intention is to account for the shortfall in play space area through a financial contribution within the S106 agreement.



Children Yield & Target Play Space (ages 0-17) - Phases 1B & 2 only

Age Group	No. of Children	Target Play Space (m2)
Ages 0-4	70.3	703
Ages 5-11	54.6	546
Ages 12-15	26	260
Ages 16-17	13.7	137
Total	164.6	1646

Play Area Calculation

Area	Play Provision Area (m2)
Phase 1B & 2 - First Floor Communal Gardens	946
Avondale Drive Frontage - Play on the Way	137
Hitherbroom Link	187
Total on-site provision	1270
Target play provision	1646

KEY

- New/improve public amenity space
- Communal residential amenity space
- Equipped play (0-12 year olds)
- Doorstep Play & Play-on-the-way

A / 173

A / 174

A / 175

A / 176

A / 177

M / 171

M / 172

5.2 PUBLIC REALM DESIGN

5.2.1 Street Frontages

The landscape proposals for the frontages to Avondale Drive and Abbotswood Way aim to increase greening through trees and structural planting. The proposals provide additional tree planting to the frontage, with private amenity spaces and entrances delineated through railings and structural evergreen hedging.

To the south-east of the site, where Avondale Drive meets Abbotswood Way, an area of increased planting is provided amongst the existing retained trees. This includes additional tree planting alongside play on the way features.

To Abbotswood Way, rain gardens are proposed with tree planting and a suitable planting mix for both seasonally wet and drought conditions.

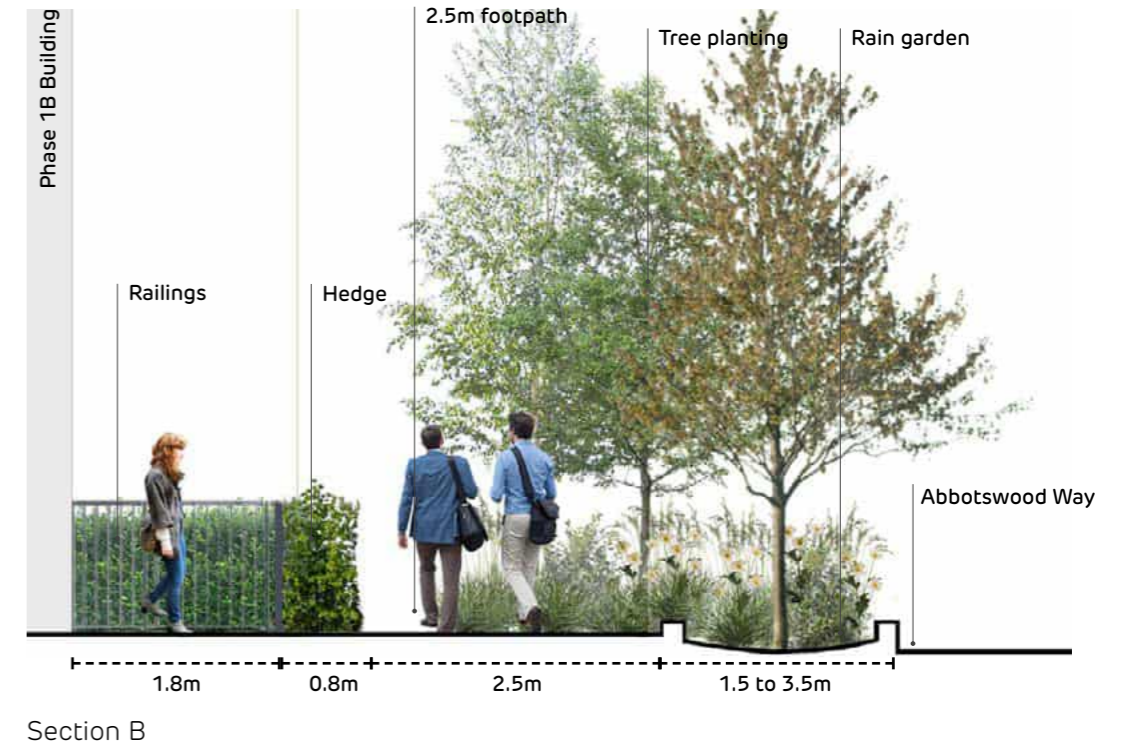
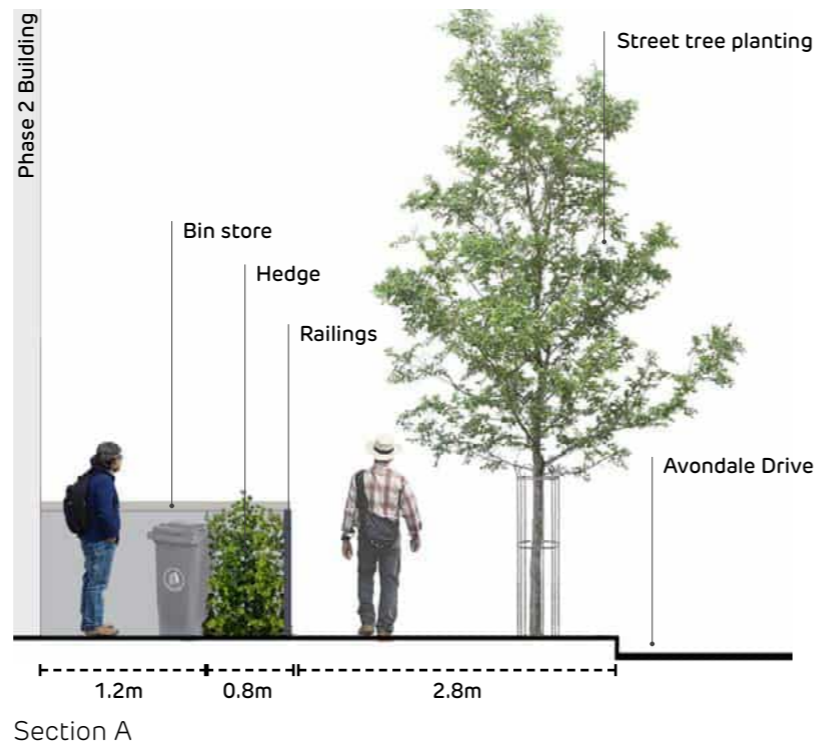

A / 129

M / 122

M / 126

M / 130

M / 137

M / 140

PUBLIC REALM DESIGN

5.2.2 Hitherbroom Link

The Hitherbroom Park provides an area of public realm at the heart of the development, providing a link through to Hitherbroom Park.

The proposals include three key character areas across a unified public realm, the intent being to provide a gradual transition and softening as users approach the park itself. At the centre of the proposals is the now retained Wild Cherry. This provides a strong focal point and instant greening to the space, beneath this is an area of feature paving and seating.

To the Avondale Drive frontage, the design is more open, with visual and pedestrian permeability provided through various walking routes. Incidental play equipment is proposed to create a child friendly environment, whilst rain gardens provide SUDS benefits.

To the north, another large rain garden is proposed with play on the way features leading up to the Hitherbroom Park connection. The main path includes seating opportunities amongst the existing and proposed trees.

Ample seating is provided across the public realm area, allowing various opportunities for rest and socialising in both full sun and areas of shade.

The public realm is flanked by private amenity spaces, these include structural evergreen hedging for defensible space, however they also provide passive surveillance over the public realm area.



- A / 128
- A / 129
- A / 173
- A / 174
- A / 175
- A / 176
- A / 177
- M / 122
- M / 123
- M / 127
- M / 139
- M / 171
- M / 172



JUMPING DISCS BY TIMBERPLAY



SMALL WHEELCHAIR CAROUSEL BY TIMBERPLAY



TIMBER WALKWAY OVER RAIN GARDEN AS PLAY ON THE WAY



EXISTING WILD CHERRY AS FOCAL POINT



ELEMENTS BENCH BY FURNITUBES; TO MATCH PHASE 1



SHEFFIELD CYCLE STANDS; STAINLESS STEEL



MIXED CUBE SEAT BY WOODSCAPE

PUBLIC REALM DESIGN

Hitherbroom Link

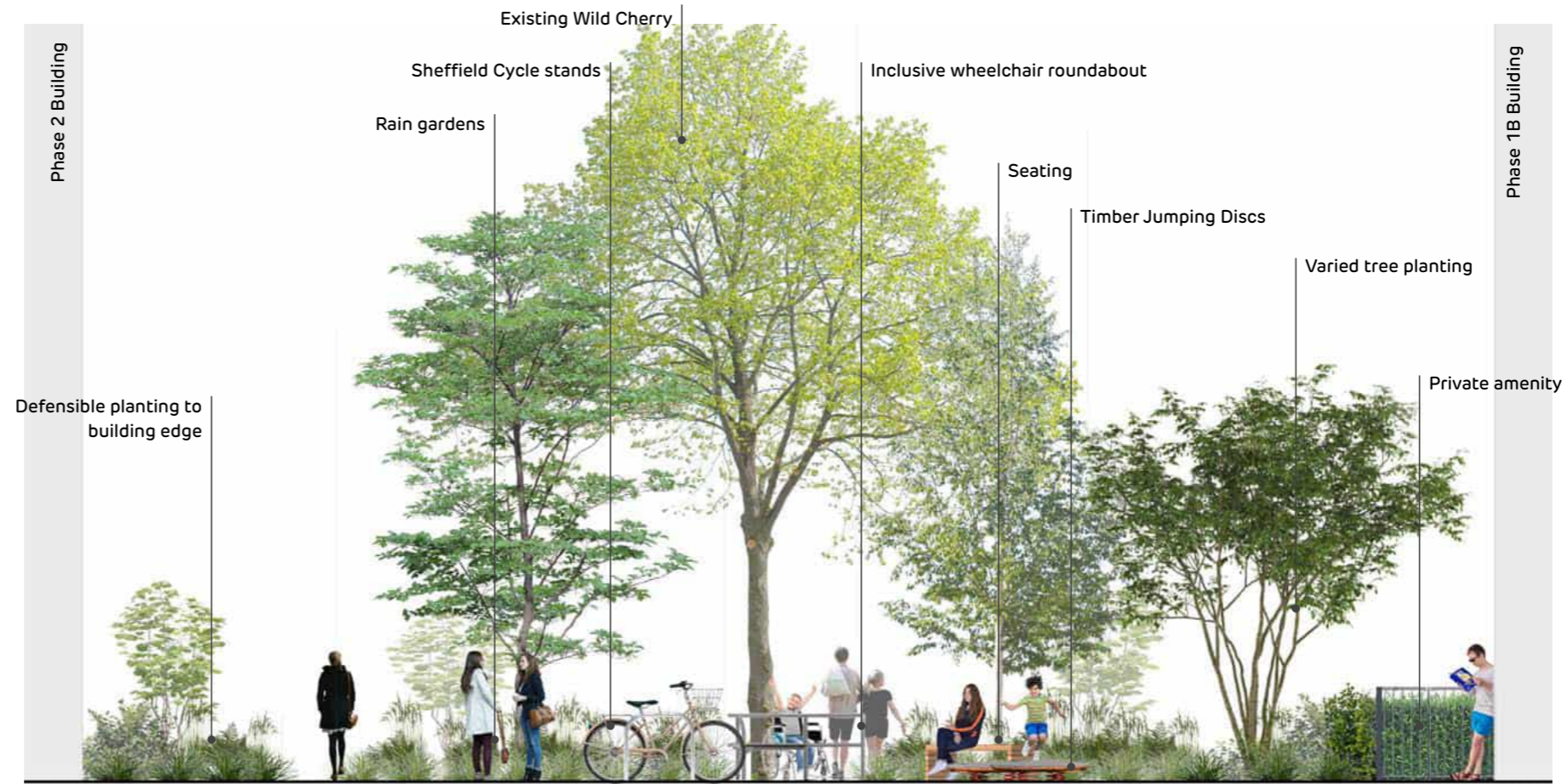

SECTION A

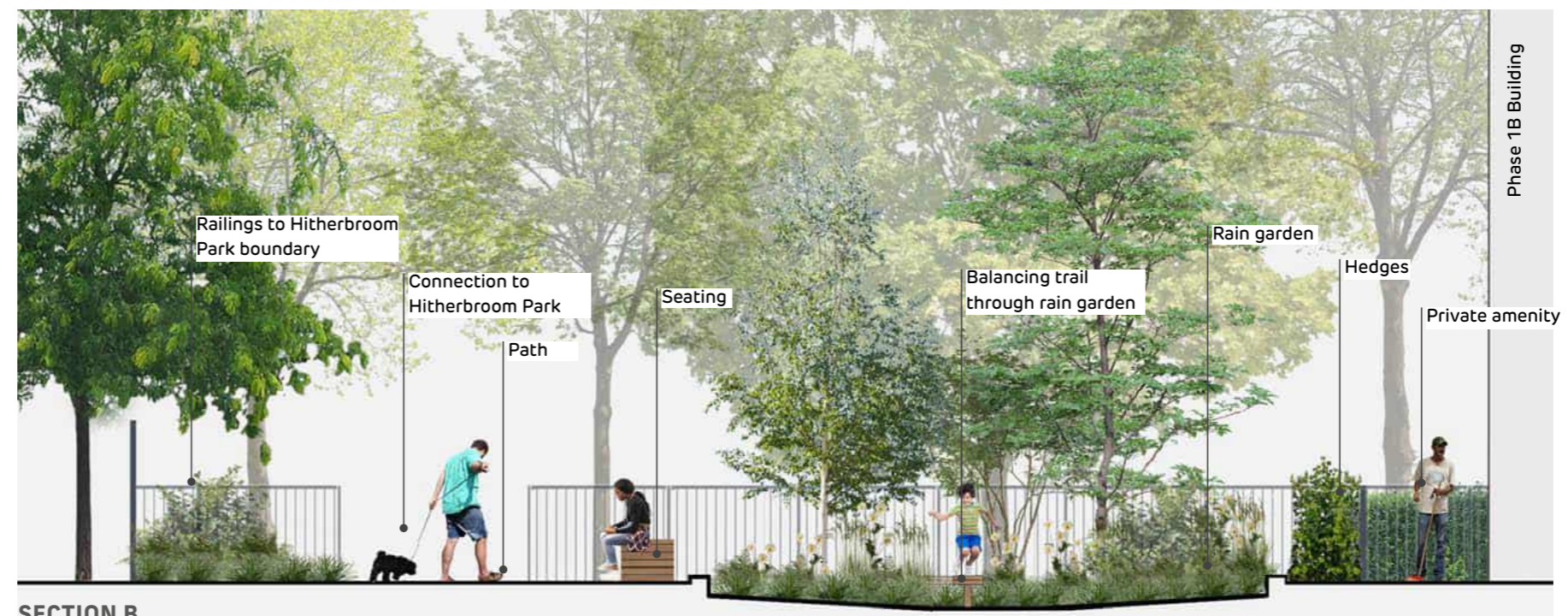

SECTION B

PUBLIC REALM DESIGN

5.2.3 Communal Gardens - Phase 2

The Phase 2 communal gardens occupy two spaces at first floor level. These are intended for recreational use by residents and as doorstep play areas for under 5's.

The designs aim to provide a playful environment, with fixed equipment combining into routes around the spaces. A perimeter path wraps around both courtyards, with tree planting, grass, benches and gravel gardens to the centre.

The majority of planting will be in metal raised beds, with the heights varying to suit planting requirements (additional growing medium for tree planting). Gravel gardens combine with play, providing a natural play feature within each space.

Play is focused on under 5's, with sculpture and imaginative features proposed to assist in child development. These are combined with natural play features and elements such as boulders, planting, and sculptural bee hotels, to create a dynamic space.

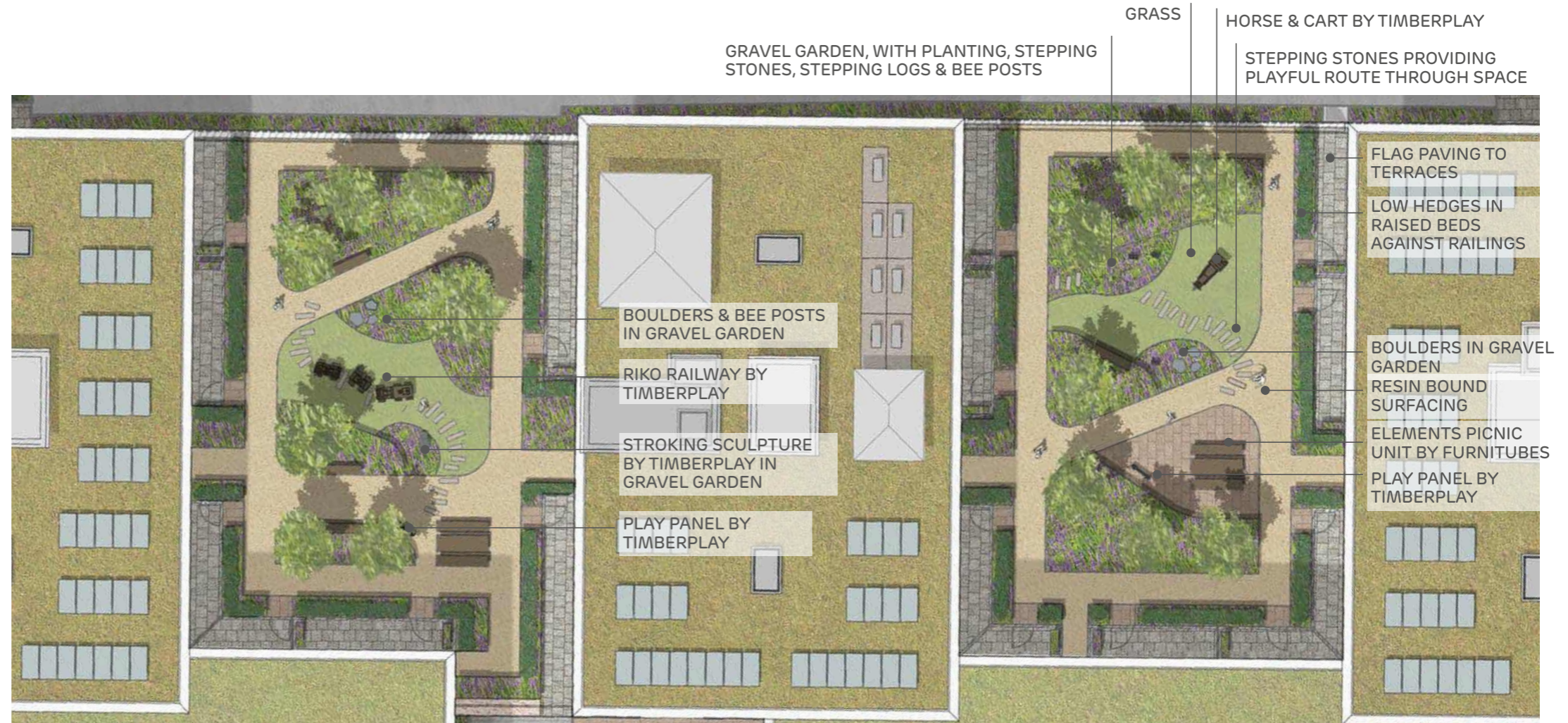

ELEMENTS PICNIC SET BY FURNITUBES; FRAME ENDS

ELEMENTS PICNIC SET BY FURNITUBES; FRAME ENDS



TIC-TAC TOE BY TIMBERPLAY



BEE HOTELS BY VESTRE



SMALL PLAY BOULDERS IN GRAVEL GARDENS



'STROKING' SCULPTURES BY TIMBERPLAY (IMAGE ILLUSTRATIVE)



RIKO RAILWAY BY TIMBERPLAY



HORSE AND CART BY TIMBERPLAY



STEPPING LOGS



STEPPING STONES CREATING PLAYFUL ROUTES/TRACKS

- A / 162
- A / 163
- A / 164
- A / 165
- A / 166
- A / 167
- A / 168
- A / 170
- A / 175

- M / 157
- M / 158
- M / 159
- M / 160
- M / 161
- M / 171
- M / 172

PUBLIC REALM DESIGN

5.2.4 Communal Garden - Phase 1B

The Phase 1B communal garden follows similar principles to Phase 2, however includes a wider area. This allows for large equipment for toddlers, alongside inclusive equipment.

The design links the spaces together with primary routes, these then connect into the private amenity spaces which have access directly onto the communal garden.

Planting is within raised beds, with large beds where tree planting is included.



- PLAY PANEL BY TIMBERPLAY
- ELEMENTS PICNIC UNIT BY FURNITUBES
- ROCKING PLATE BY TIMBERPLAY (SUITABLE FOR WHEELCHAIR USERS)
- GRAVEL GARDEN WITH BOULDERS, STEPPING ROUTE & BEE HOTELS
- INDIVIDUAL PLANTERS WITH CLIMBERS AGAINST PRIVACY SCREENS
- MIXED CUBE SEATS BY WOODSCAPE
- GRAVEL GARDEN, WITH BOULDERS, BEE HOTELS, STROKING SCULPTURES & STEPPING STONE TRAIL
- COMES AROUND BY TIMBERPLAY; CHILD IMAGINATIVE SEAT
- PLAY PANEL BY TIMBERPLAY
- MIXED CUBE SEATS BY WOODSCAPE
- TOTTER TRAIL BY TIMBERPLAY
- LAWN



TOTTER TRAIL BY TIMBERPLAY



ROCKING PLATE BY TIMBERPLAY (SUITABLE FOR WHEELCHAIR USERS)



MIXED CUBE SEAT BY WOODSCAPE



STEPPING LOGS



BEE HOTELS BY VESTRE



CANTILEVER BENCH ON METAL PLANTERS



COMES AROUND BY TIMBERPLAY



SMALL PLAY BOULDERS IN GRAVEL GARDENS

- A / 162
- A / 163
- A / 164
- A / 165
- A / 166
- A / 167
- A / 168
- A / 170
- A / 175
- M / 157
- M / 158
- M / 159
- M / 160
- M / 161
- M / 171
- M / 172

5.3 PLANTING STRATEGY

5.3.1 Retained & Removed Trees

Existing trees are retained where possible, with those retained utilised as key features within the landscape.

The loss of existing trees is countered by the large quantity of new trees proposed across the two phases as identified on the follow pages and within the planting proposals.

For further information on the existing trees and vegetation refer to the Arboricultural Impact Assessment produced by Middlemarch in November 2025, submitted as part of the pending S73 application.

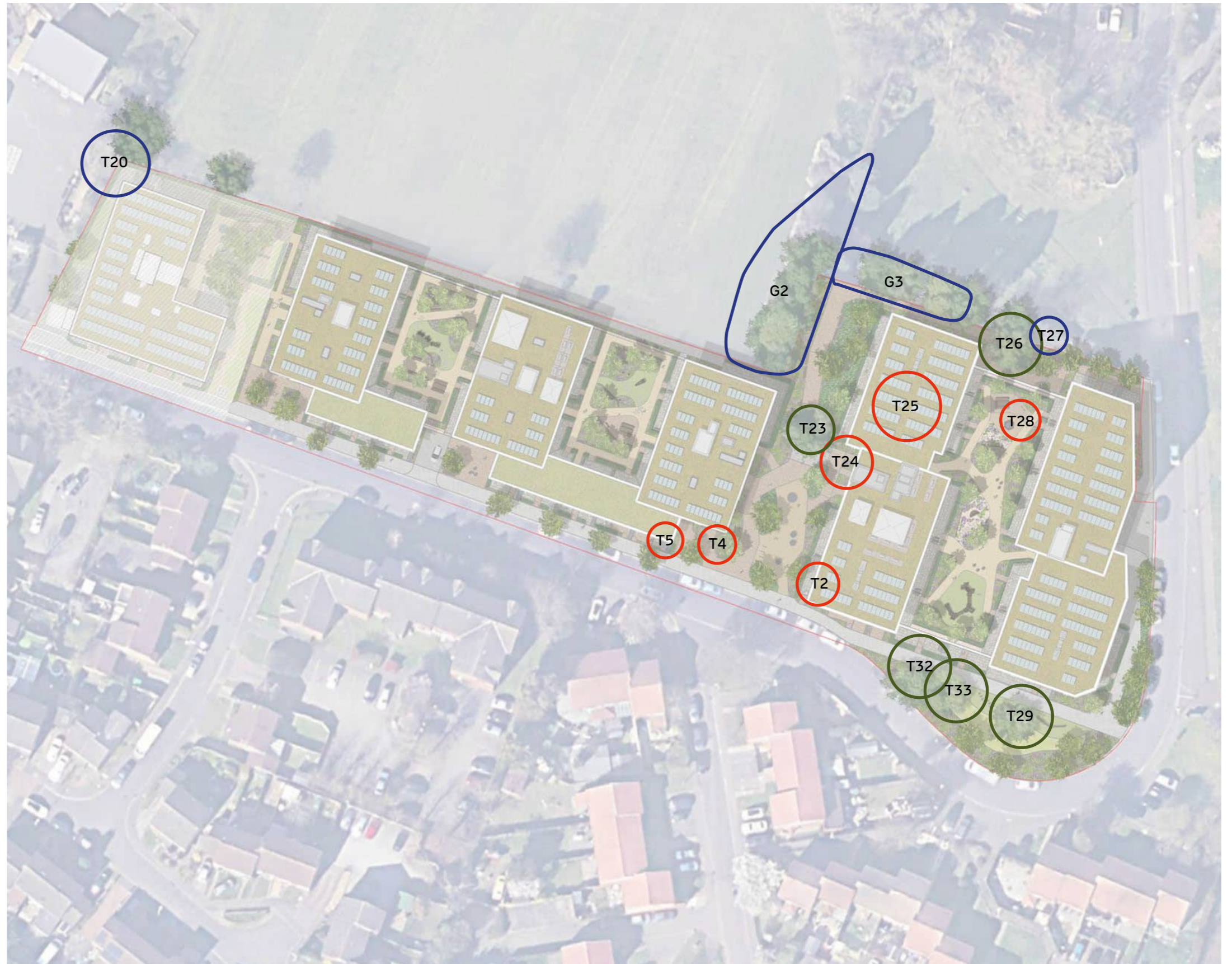

KEY

- Existing trees to be removed
- Existing trees retained - on site
- Existing trees retained - off site, overhanging
- T11 Existing tree reference; as per Middlemarch Arboricultural Report

PLANTING STRATEGY

5.3.2 Tree Planting Strategy



The tree planting strategy has been developed based on the following core principles:

- Provide greening to public realm
- Provide urban greening/canopy cover
- Demonstrate seasonal interest throughout year
- Be climate resilient (heat and flood resistant where required)
- Incorporate a wide range of species for improved biosecurity
- Include native cultivars where suitable
- Create interest through varied texture, shadow, and silhouettes
- Provide tree lined streets to Avondale Drive and Abbotswood Way
- Provide variety in height and form through the use of clear stem and multi-stem specimens.
- Incorporate pollution tolerant and pollution absorbing species to streets where suitable.

The scheme has been developed with a strong focus on climate resilience and biosecurity. This involves planting a wide range of species, alongside ensuring the majority of species are suited to drought and flood conditions. The table on the following page provides an evidence based approach to tree selection based on climate resilience factors.

In total a total of 64 new trees are proposed on the scheme. 36 of these are at ground floor, with 28 proposed to the 1st floor courtyard.

For precise tree specifications and locations refer to drawings: AVD-LLA-ZZ-GND/01-GA-L01-1201 to 1207



KEY

- Trees in hard landscape
- Specimen trees
- Rain Garden Tree
- Small/medium sized trees to public realm
- Medium/large sized native tree to Avondale Drive/Abbotswood Way open space
- Multi-stem tree to 1st floor courtyards

A / 166	A / 168	A / 190	A / 191	A / 198	A / 199	A / 200	A / 202	A / 203	A / 224
M / 194	M / 195	M / 196	M / 214						

PLANTING STRATEGY

5.3.3 Key Tree Species



STREET TREES



H
Ulmus 'New Horizon'



N RG
Alnus glutinosa 'Laciniata'

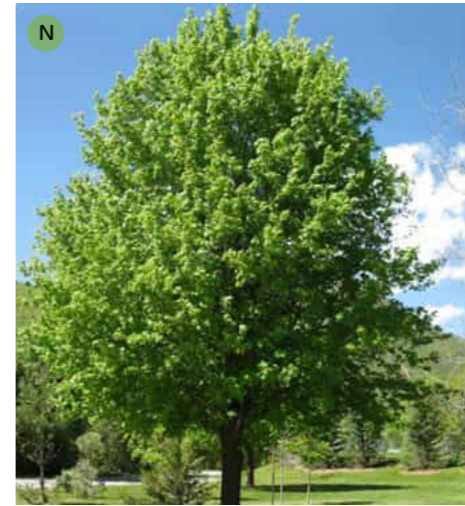

N
Acer campestre



N
Carpinus betulus

HITHERBROOM LINK TREES



S
Gleditsia triacanthos 'Skyline'



S MS
Koelreutia paniculata



RG
Ginkgo biloba

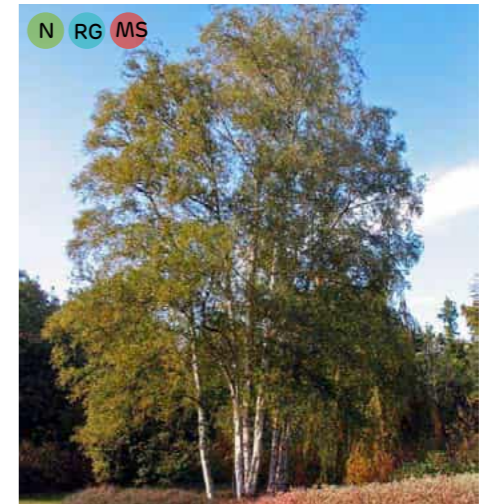

N RG MS
Betula pendula

PODIUM COURTYARD TREES



MS
Cornus mas



MS EG
Magnolia grandiflora 'Ferruginea'



MS
Amelanchier lamarckii



MS
Cercis silaquastrum

- Key
- H** Hard Landscape Tree - suitable for planting with structural cells
 - N** Native or Native Cultivar
 - RG** Rain Gardens (suitable for)
 - S** Specimen Tree
 - MS** Multi-stem
 - EG** Evergreen (as part of wind mitigation strategy)

PLANTING STRATEGY

5.3.4 Climate Resilience

Table indicates an assessment of each tree proposed, identifying characteristics and aspects of climate resilience. Trees have been selected to provide a highly resilient scheme, whilst maintaining native and native cultivars wherever possible. A wide variety of species is proposed for biosecurity purposes.

Mature sizes taken from Barchams, RHS and Van den Berk data.

Drought, flood, wind and salt tolerance from 'The Tree Selection Guide' by H. Sjoman & A Anderson (in association with Royal Botanic Gardens, Kew).

Species	Characteristics	Mature Size	Drought Tolerance	Flood Tolerance	Wind Tolerance	Salt Tolerance	Native Cultivar
Acer campestre	<ul style="list-style-type: none"> Pioneer species Seasonal interest (autumn foliage) Air pollution tolerant 	H: 7-12m D: 4-8m	High	Medium	High	Low	Y
Acer campestre 'Lienco'	<ul style="list-style-type: none"> Narrow, fastigate species Seasonal interest (autumn foliage) Air pollution tolerant 	H: 7-12m D: 3-5m	High	Medium	High	Low	Y
Acer platanoides 'Crimson Sentry'	<ul style="list-style-type: none"> Columnar tree (used closer to building) Season interest (autumn foliage) 	H: 3-8m D: 3-5m	Low	Medium	High	High	N
Acer x freemanii 'Autumn Blaze'	<ul style="list-style-type: none"> Large feature tree Seasonal interest (autumn foliage) 	H: 12-17m D: 9-14m	Medium	High	Medium	Medium	N
Alnus glutinosa 'Laciniata'	<ul style="list-style-type: none"> Pioneer species Planted in rain gardens to suit wet soils Air & ground pollution tolerant & absorbent Finely cut deep green leaves (creates interesting shadows/silhouettes) 	H: 17-22m D: 7-10m	Low	Medium	High	Medium	Y
Alnus incana	<ul style="list-style-type: none"> Pioneer species Planted in rain gardens to suit wet soils Air & ground pollution tolerant & absorbent Narrow for than Alnus 'Lacinata' for slightly narrow spaces 	H: 17-22m D: 4-8m	Medium	High	High	High	N
Amelanchier lamarckii	<ul style="list-style-type: none"> Year round seasonal interest (blossom, berries, autumnal foliage) Multi-stem - provides low level/understorey greening 	H: 3-5m D: 3-4m	Medium	Low	High	Low	N
Betula pendula	<ul style="list-style-type: none"> Pioneer species Winter interest (bark) Multi-stem 	H: 12-17m D: 8-10m	Low	Medium	High	Medium	Y
Carpinus betulus	<ul style="list-style-type: none"> Large native tree 	H: 20+ D: 8-12m	Medium	Low	High	Medium	Y
Cercis siliquastrum (1st floor Courtyards)	<ul style="list-style-type: none"> Small specimen Season interest (flowering & foliage colour) 	H: 3-7m D: 4-6m	High	Low	Medium	Medium	N
Cornus mas (1st floor Courtyards)	<ul style="list-style-type: none"> Multistem Seasonal interest (flowers, autumn colour) 	H: 5-6m D: 5-6m	High	Low	High	High	N
Corylus colurna	<ul style="list-style-type: none"> Thrives in urban environments Can tolerate maintenance for crown lifting (used to Hitherbroom Park boundary), allows for surveillance & openness to be maintained 	H: 20+m D: 8-12m	High	Low	High	High	N
Ginkgo biloba	<ul style="list-style-type: none"> Thrives in urban environments Pollution tolerant (air & soil) 	H: 20+m D: 4-8m	High	Low	High	High	N
Gleditsia triacanthos 'Skyline'	<ul style="list-style-type: none"> Thrives in urban environments Pollution tolerant (air) Salt tolerant 	H: 12-17m D: 7-11m	High	Medium	High	High	N
Koelreutia paniculata	<ul style="list-style-type: none"> Feature tree Harder, highly climate resilient species Seasonal interest (flowering & autumnal foliage) Pollution tolerant 	H: 10-15m D: 5-9m	Medium	Low	Medium	Medium	N
Magnolia grandiflora 'Ferruginea' (1st Floor Courtyards)	<ul style="list-style-type: none"> Evergreen (used as part of wind mitigation) Season interest (flowering) Multi-stem 	H: 4-8m D: 4-8m	Low	Low	Medium	Low	N
Ulmus 'New Horizon'	<ul style="list-style-type: none"> Suitable for urban environments Provides strong structural form 	H: 8-12m D: 4-8m	High	Low	High	High	N

PLANTING STRATEGY

5.3.5 General Planting Strategy

The planting proposals intend to provide a dynamic, vegetated environment for site users, working with the architectural form and public realm design. Planting is designed to demonstrate seasonal interest, create movement, include plants for pollinators, and provide a dense, green, planting palette. Hedges and evergreen shrubs provide year round interest and a backbone to the proposals, whilst herbaceous perennials provide moments of seasonal colour and interest.

For full planting proposals and species-lists to palettes refer to drawings:

AVD-LLA-ZZ-GND/01-GA-L01-1201 to 1207.

KEY

- Palette 1; Street Frontage
- Palette 2; Rain Garden - Site Periphery
- Palette 3; Rain Garden - Internal
- Palette 4; Northern Boundary Planting
- Palette 5; South-Eastern Road Edge
- Palette 6; East/West Facing Ornamental
- Palette 11; 1st Floor - Central Feature Beds
- Palette 12; 1st Floor - Building Edge
- Hedging
- Climbers to Phase 2 Northern Boundary
- Lawn
- Species-rich Meadow



- A / 166
- A / 168
- A / 191
- A / 192
- A / 204
- A / 205
- A / 206
- A / 215
- M / 208
- M / 214



PLANTING STRATEGY

5.3.6 Green & Brown Roofs

The building roofs include a large coverage of both green and brown/biodiverse roofs.

Biodiverse/brown roofs cover the majority of the higher roof levels. These are designed as a suitable substrate and allowed to self-colonise. These areas are continued beneath the PV panels. The plans indicate these areas indicatively, additional paths and perimeters will need to be included between access, plant and maintenance areas.

Substrate depths are to be between 80-150mm, allowing for undulations for increase habitat creation. Beneath PV panels substrate is to be level.

Areas of additional habitat creation are to be located to green roof areas and larger areas of brown roofs, this can include items such as gravel, crushed concrete, fixed log piles, rope coils etc. to a qualified ecologists recommendations.

Green roof seeded with species-rich wildflower seed mix. Seed mix to be specialised to urban situations, containing plants that are able to absorb pollution and CO2 and include Plants for Pollinators.

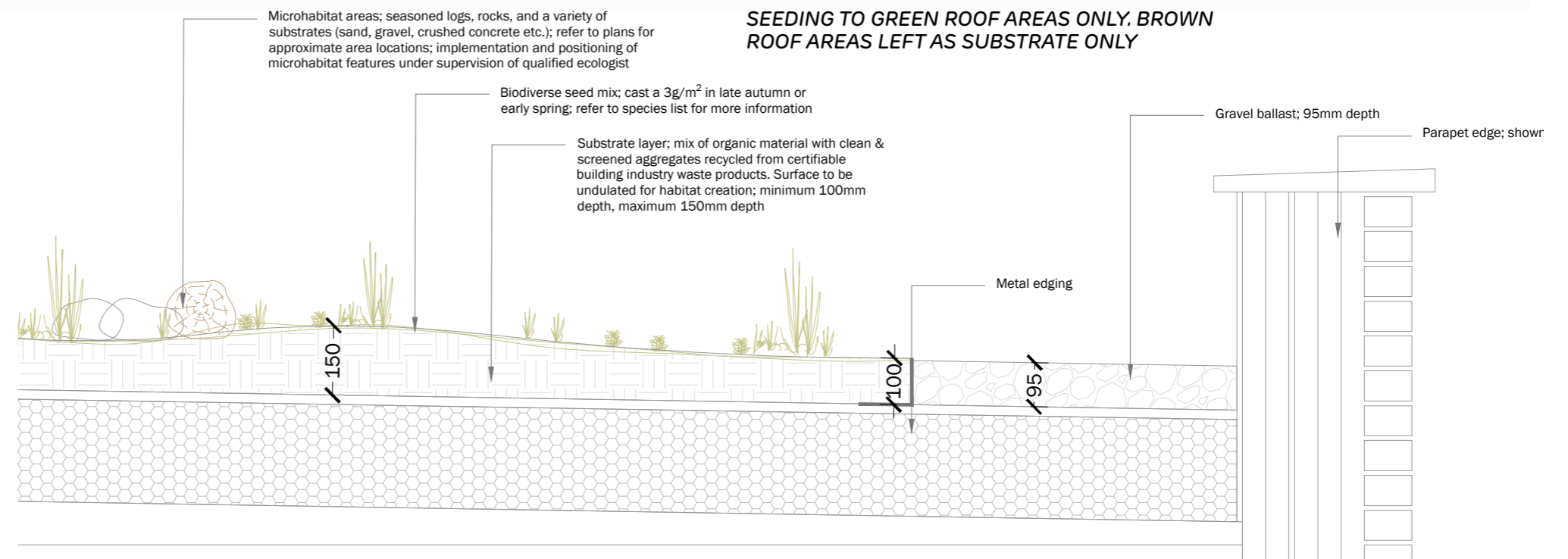

KEY

 Brown roofs; substrate only, no seeding/ planting

 Green roofs; substrate with wildflower seeding

5.4 LANDSCAPE MATERIAL STRATEGY

5.4.1 Surfacing Strategy

The surfacing strategy is designed to provide a coordinated and unified proposal with the architectural treatment and the existing Phase 1 development.

The proposals are based off the following key criteria:

- Continuity with Phase 1 materiality
- Complement architectural treatment; particularly brick colour
- Signify areas of pedestrian priority and use through changes in materials, particular to the Hitherbroom Link public realm
- Provide a subtle approach that emphasises existing and proposed trees, alongside the extensive areas of soft landscape.
- Provide a functional and durable landscape with longevity and minimal maintenance.



KEY

- Block paving to private entrances & Hitherbroom Link; Burnt Ochre colour; stretcher bond
- Block paving to vehicle entrances; grey
- Macadam pavements
- Private patios/terraces; flag paving; stretcher bond; as per Phase 1
- Resin bound paths to communal gardens; buff; as per Phase 1
- Setts; 100x100mm; grey; no dig buildup
- Wetpour surfacing; buff/eggshell colour



LANDSCAPE MATERIAL STRATEGY

5.4.2 Boundary Treatment Strategy

The diagram illustrates the proposed boundary treatments for the site. This follows the precedent from Phase 1, and is based on the following key points:

- School boundary; following feedback from the public consultation, the boundary here is to be screened with vegetation where possible. The existing mesh fence is retained, with evergreen hedging plant to the two ends of Phase 2. To the centre, climbers are planted to provide a green wall to the northern elevation of the Phase.
- Private terraces follow the Phase 1 design, coordinating with it and the architectural metalwork
- The Hitherbroom Park boundary is to be replaced with a 1.2m high metal railing. This is intended to improve surveillance and provide greater openness to the route to the north of Phase 1B.



KEY

- Existing boundary treatment retained. Hedges grown to private terraces, climbers against building for majority of Phase 2 for visual screening
- Tall railings to match Phase 1
- Metal railings to Hitherbroom Park; black; vertical bar
- Metal railings to private terraces/front gardens; to match Phase 1
- Balustrade on parapet to architects details for fall protection
- Timber batten fences as privacy panels to communal terraces
- G Gate locations; to match railings
- External private bin stores; as front terrace division

LANDSCAPE MATERIAL STRATEGY

5.4.3 External Furniture Strategy





External furniture is situated throughout the development, providing various places to sit within different site conditions.





To the ground floor, seating areas are positioned to the main core entrances, alongside within the Hitherbroom Link public realm design. Seating opportunities have been developed based on the daylight/sunlight analysis, providing areas for rest within areas of regular sun and shade.

The proposals have been developed with input from the wind mitigation specialists, allowing for the careful positioning of seating areas to suit likely wind conditions.



KEY

-  Proposed seating
-  Proposed litter bins
-  Proposed cycle stands
-  Proposed removable bollards

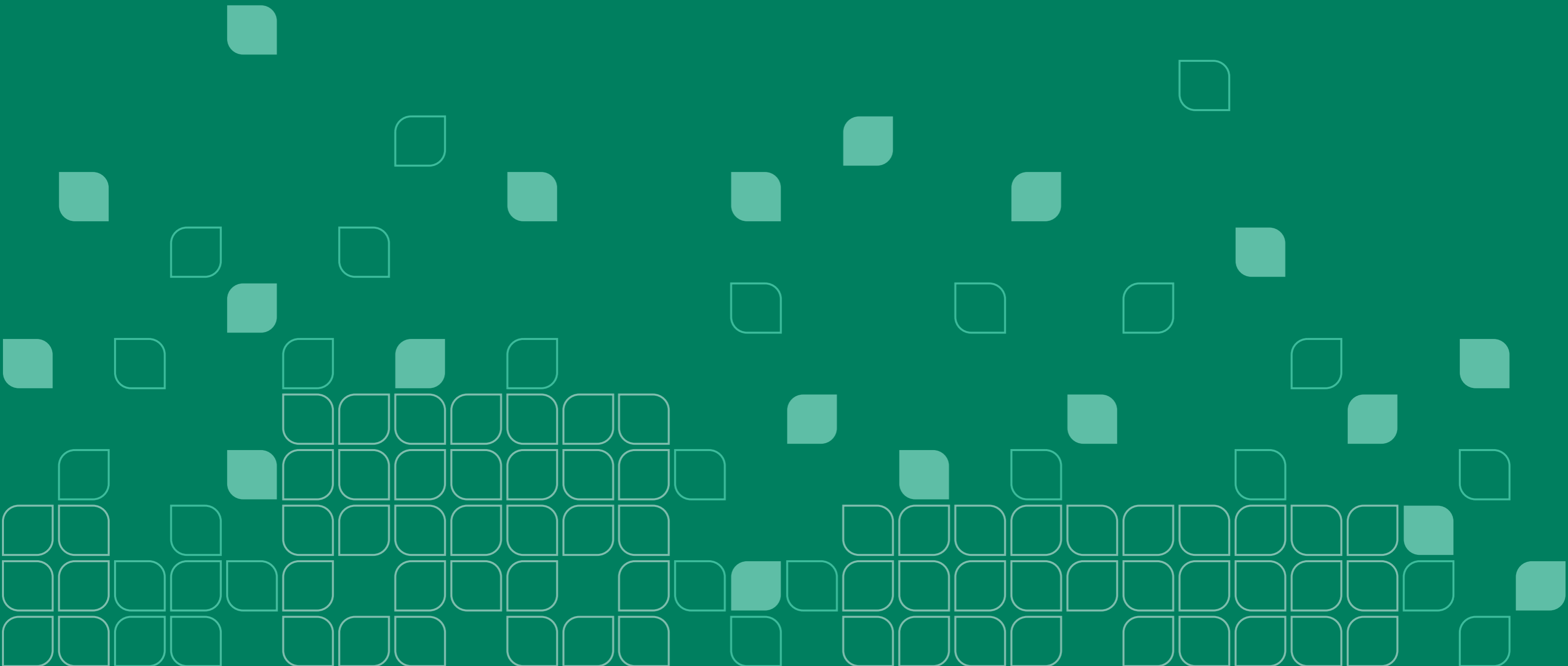

6. ARCHITECTURAL EXPRESSION

6.1 CONTEXT STUDIES

6.1.1 Surrounding Context

IMMEDIATE CONTEXT

The site sits in a mostly residential area, surrounded by lots of 2-3 storeys and low-mid rise blocks of flats.

1980's housing developments are located opposite the site on Avondale Drive and to the north of Hitherbroom Park consisting of low rise apartment buildings and houses. The wider area is predominantly post-war semi-detached houses.

Whilst varying stylistically with the ages at which each house was built, a continuous domestic architectural language and detailing is characteristically dominant in the area, reflective of the largely residential uses.

VARYING ARCHITECTURAL STYLES



Avondale Drive Estate



Minet Clinic



Avondale Drive



Clivesdale Drive



Hitherbroom Road 1960's Houses



Birchway 1920's Houses

CONTEXT STUDIES

6.1.2 Material & Architectural detailing study

IMMEDIATE MATERIAL CONTEXT

Brick is used as the primary building material, featured in a range of different tones across the local area. Varying red-ish tones are most predominant, but lighter buff, yellow and darker tones are also used in clusters of houses.

IMMEDIATE DETAILING CONTEXT

Architectural detailing of the immediate context is generally quite simple and domestic, given the nature of the predominantly low-rise homes. Simple horizontal banding, brick header coursings and corner details are frequently used to add some architectural interest to domestic building forms.

The nearby Minet Clinic expresses a simple Art Deco style with it's wide horizontality and window proportions contrasted by a long vertical window expressing the staircase behind.

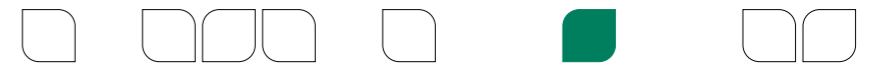

BRICK TONES

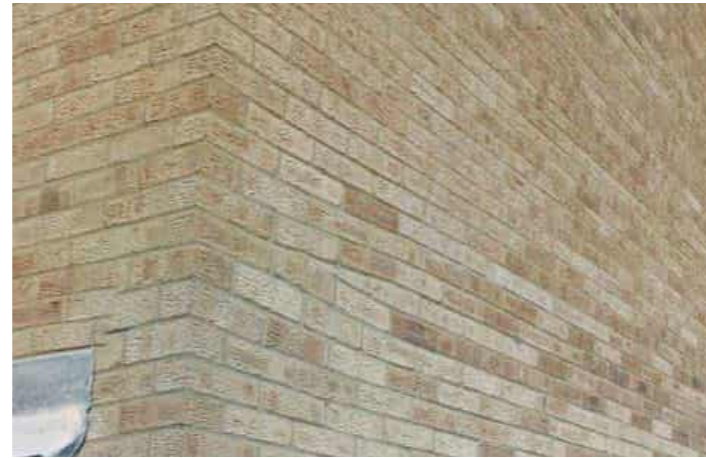

Light brick

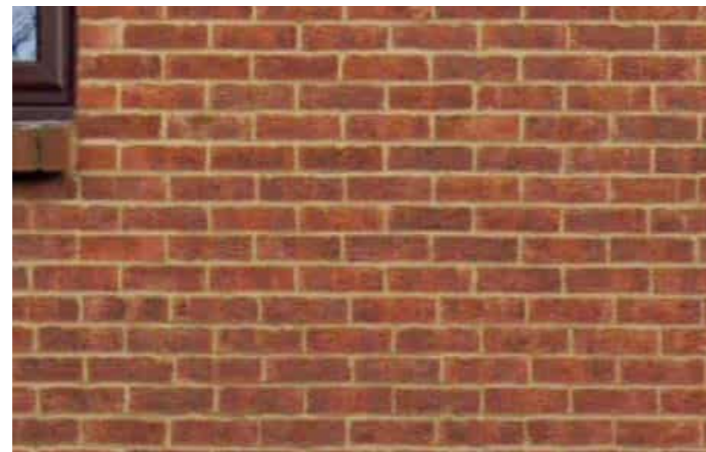

Medium brick



Dark brick

RESIDENTIAL DETAILING



Inset banding



Corner details

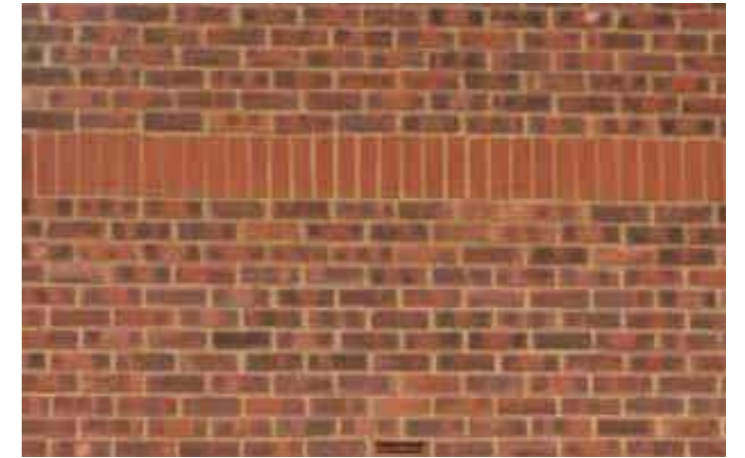

Patterned brickwork coursing

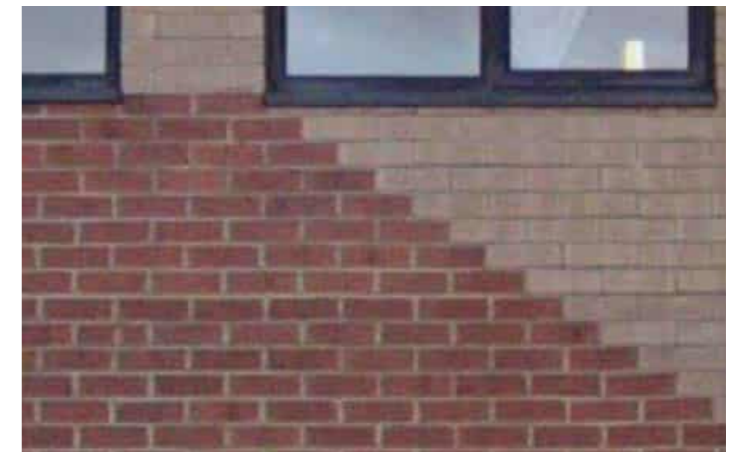

Patterned brickwork colours

MINET CLINIC DETAILING



Expressed Horizontality



Vertically expressed staircase fenestration

CONTEXT STUDIES

6.1.3 Avondale Drive Phase 1A

PHASE 1A CONTEXT

The completed phase 1A block sits on the West-side of the site, setting an architectural language precedent for the rest of the outline development to respond to.

The base brick is a red-brown colour, used for the main facade. Brick detailing, inspired by the surrounding context, using a dark claret colour is then used around the entrance, duplex frontages along the street, around balconies and windows to upper floors, to the top of the building, and around the corners.

This detailing expresses the ground floor uses and enriches the pedestrian experience of the building at the level it is most engaged with publicly.

PLANNING STAGE



CONSTRUCTED BUILDING



BRICK COLOURS

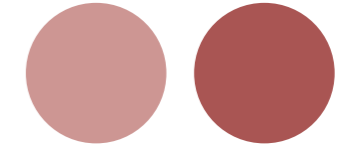

WINDOW FRAME & METAL COLOUR



6.2 ELEVATIONAL CONCEPT

6.2.1 Summary from Outline Stage

SUMMARY

The elevational concept at Outline stage focused on diagrammatically expressing the proposed massing with reference to elevational techniques used on phase 1A and found in the local context.

This focused on 3 key strategies:

- Expressing the ground floor uses, similar to the approach used on phase 1A
- Expressing each volume individually with changing main brick colours that pick up the changing brick tones of the immediate context
- Expressing the corners, similar to the technique employed on phase 1A and as per brick detailing found in the local context

A / 007-10

A / 068

M / 064-65



GROUND FLOOR EXPRESSION

"A key principle of the illustrative architectural strategy is to express the duplexes and residential lobbies individually, to signal to the building's users where the entrances are. These areas are to have a richer level of detailing as the parts that people will interact with most."

Along Avondale Drive, the duplexes along the street will have a close relationship with the residential houses opposite; the proposed architectural strategy articulates that relationship further and contrasts the massing further from the mid-scale blocks behind."

- S73 DAS Addendum to Outline Submission

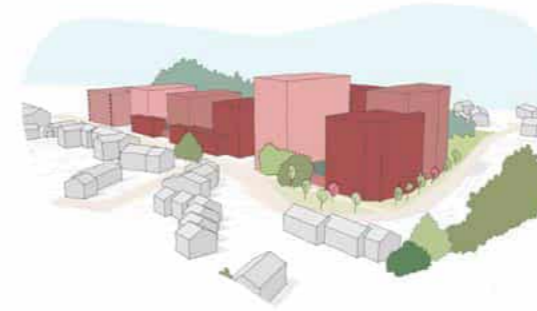
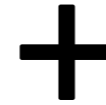

VOLUME EXPRESSION

"To provide contrast and variation throughout the masterplan, a colour gradient by block is proposed to articulate the massing and legibly differentiate volumes."

A range of bricks in complimentary colours will be used to achieve this effect, specifically chosen to compliment the phase 1a design and materiality of the surrounding context. In order to keep a calm and consistent approach across the masterplan, the number of colours will be limited, with the proposed variation and detailing highlights alternating per block, similar to the approach used on phase 1a."

- S73 DAS Addendum to Outline Submission

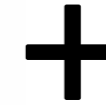

VERTICAL EXPRESSION

"Vertical expression on the corners will be used to further define the volumes adding a richness of detailing in a manner similar to that used on phase 1a. This will articulate the block's definition and complement the detailing proposed at ground floor level around entrances and duplexes."

- S73 DAS Addendum to Outline Submission



ELEVATIONAL CONCEPT

Combining these ideas formed the basis for the outline architectural elevational strategy.

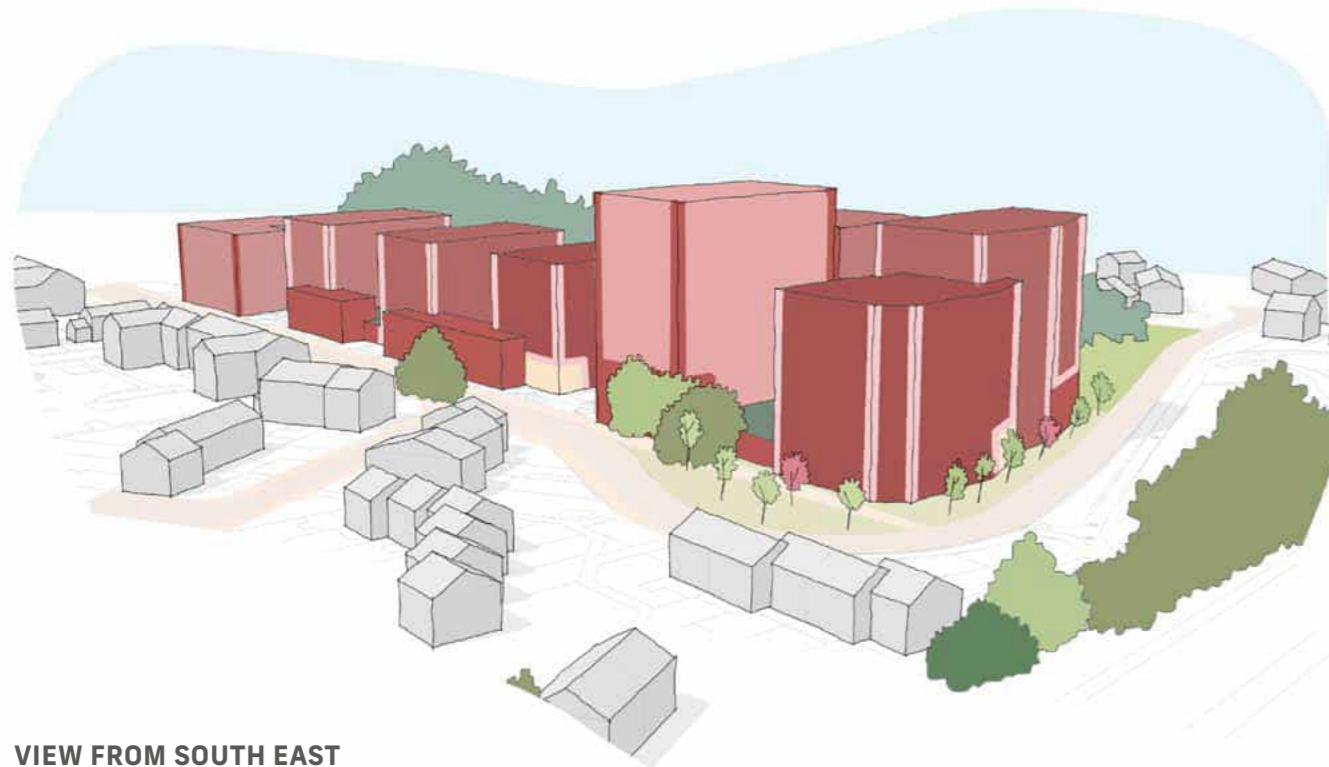

VIEW FROM SOUTH EAST



VIEW FROM NORTH WEST

ELEVATIONAL CONCEPT

6.2.2 Refined concept for RMA proposal

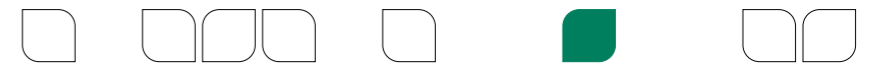

PROPOSED ELEVATIONAL CONCEPT

Refining the concept developed at Outline stage, we have kept the same 3 key strategies evident in the final RMA design, with a clearer and simpler, considered approach to materiality.

A concise palette of 3 main tones is used to express volumes, composing of a light, medium and dark brick - outlined in more detail in following pages. The intention is that the medium of these tones could match the phase 1A primary brick colour.

The vertical expression to each larger-scale block, whilst relating in language to the similar detail of phase 1A, would introduce a 4th brick tone used consistently for detailing only, similar to how the darker tone on phase 1A was used.

Refinements from the Outline concept and intentions for its application are annotated below:

GROUND FLOOR EXPRESSION CONCEPT PRECEDENTS



Phase 1A



VOLUME EXPRESSION CONCEPT PRECEDENTS



VERTICAL EXPRESSION CONCEPT PRECEDENTS



Phase 1A

A / 007-10

A / 068

M / 064-65

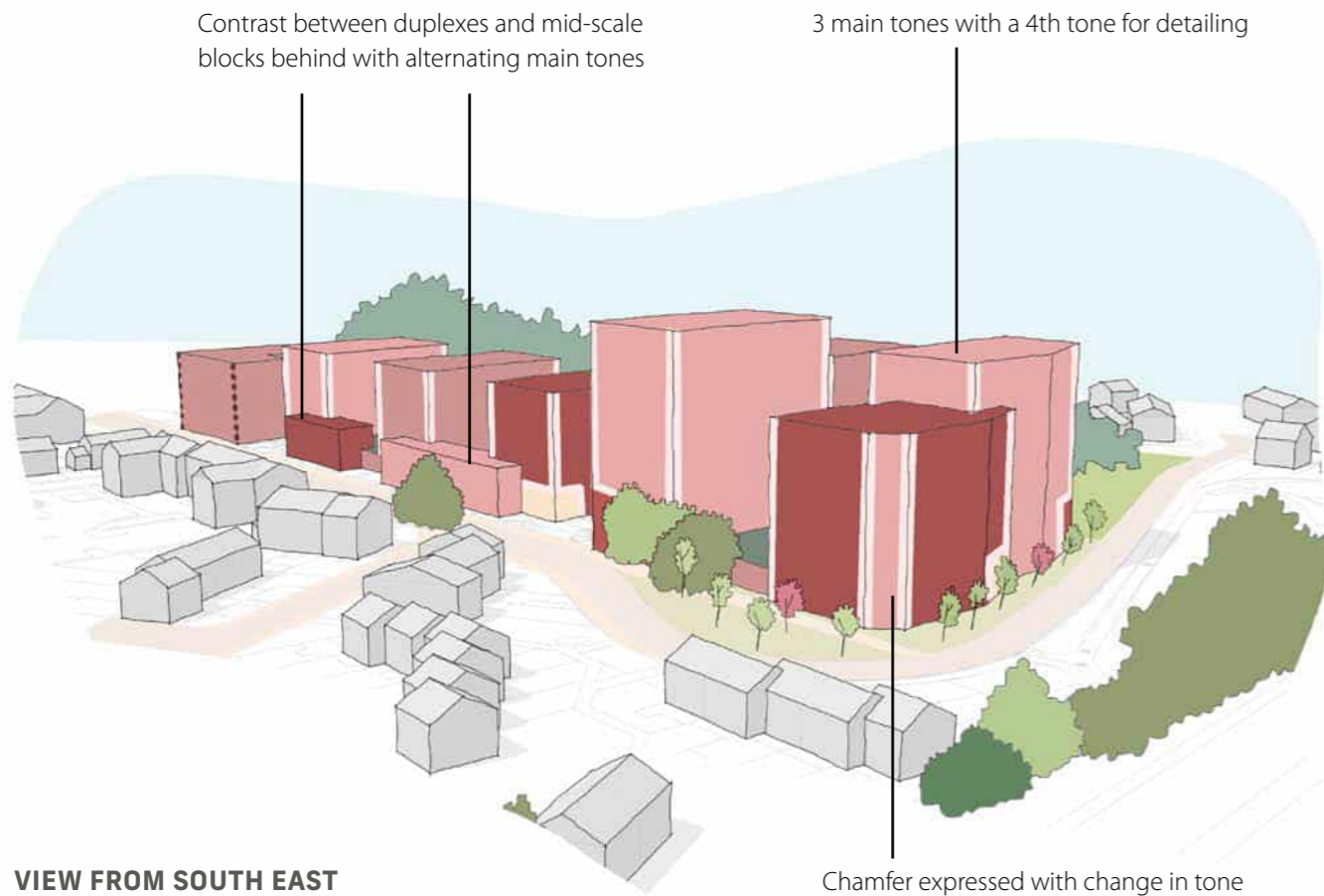

VIEW FROM SOUTH EAST

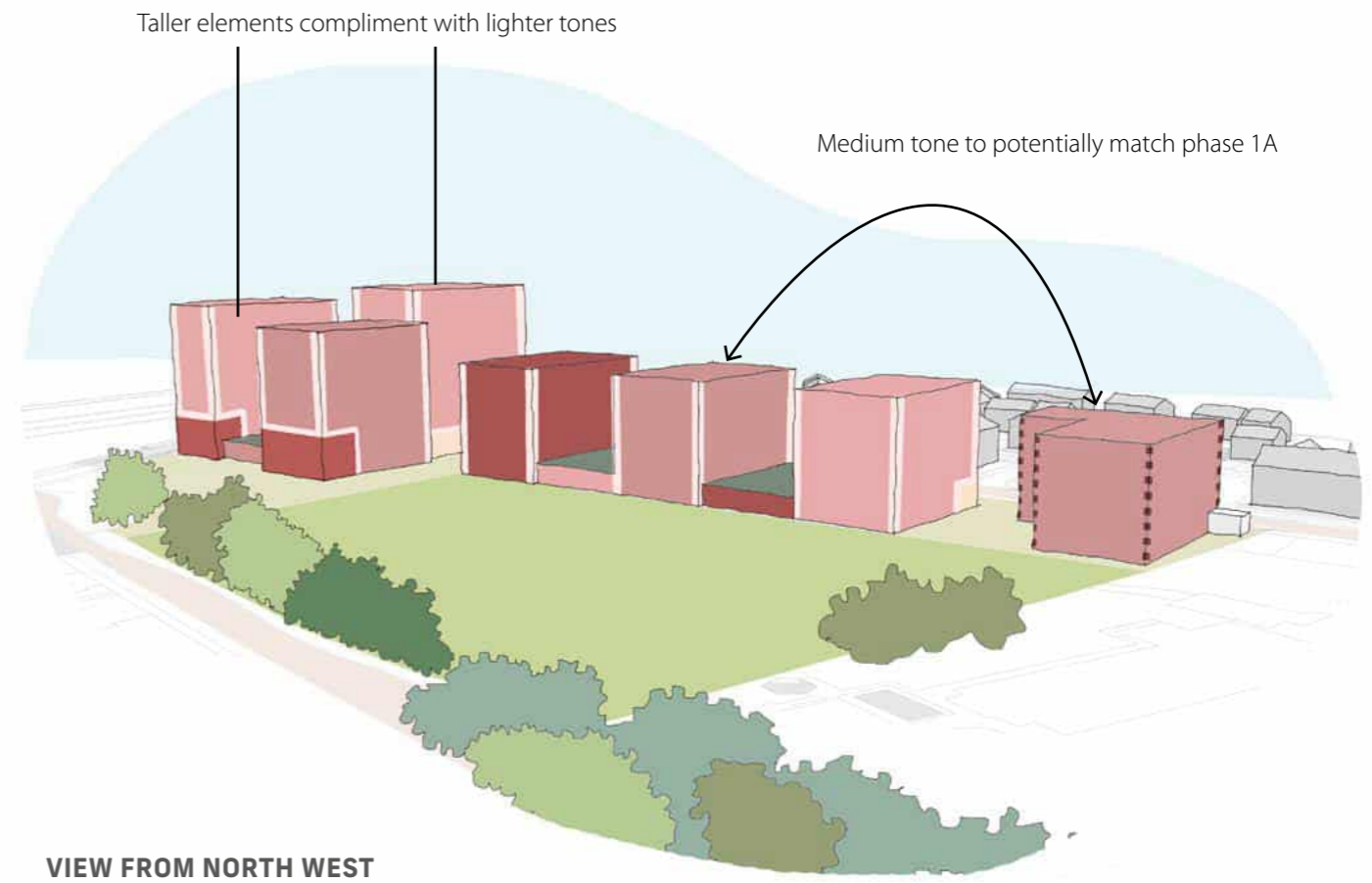

VIEW FROM NORTH WEST

6.3 MATERIALITY AND COLOUR PALETTE

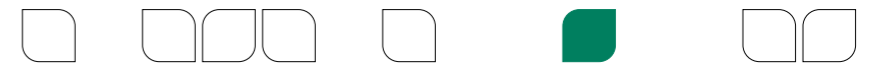

PROPOSED BRICK SELECTIONS

We have explored options for the 3 main tones: light, medium and dark as shown here.

The intention is for the medium brick to match or closely replicate the main brick colour of phase 1A, with complimentary lighter and darker red-ish tones to be used for the other main brick colours. This also responds to the predominant red-toned brick in the immediate context.

A white brick is proposed as the 4th brick tone used for detailing as it will contrast significantly with each of the 3 main tones, used to emphasise the key concepts of ground floor expression and vertical (corner) expression as intended in the elevational strategy.

CONGRUENT METALWORK

Each of the 3 main brick types will have its own congruent-toned metalwork for use in that block, creating a harmonious feel, contrary to the contrast that the white brick detailing is intended to have.

Each metalwork colour will be used for all metalwork in the block including window frames, balcony railings, canopies, panels, parapet copings, and brise soliels. Where possible, RWPs and air bricks will be colour matched too.

CONGRUENT METAL WORK AND BRICK TONES PRECEDENTS



- A / 068
- A / 071
- M / 029
- M / 046
- M / 063-66

BRICK AND METAL COLOURS



Light Brick

A light, red/pinkish toned brick with some tonal variations of a similar colour and quality to the examples given below.



Example quality - Michelmerch, Florens Reflections Poggio



Congruent Light Metalwork tone



Example quality - Michelmerch, Reflections Avorio



Congruent Light Metalwork tone



White/Pale brick

A white/off-white brick with minimal tonal variations of a similar colour and quality to the example given below.



Example quality - Bespoke Brick Company, Karma White



Medium Brick

A medium, warm red toned brick with some tonal variations of a similar colour and quality to the examples given below.



Example quality - Bespoke Brick Company, Red Multistock



Congruent Medium Metalwork tone



Example quality - Michelmerch, Gothiek

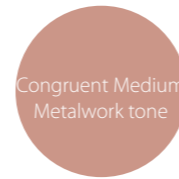

Congruent Medium Metalwork tone



Dark Brick

A dark brown, warm toned brick with less tonal variations of a similar colour and quality to the examples given below.

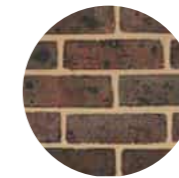

Example quality - Michelmerch, Selected Dark



Congruent Dark Metalwork tone



Example quality - Bespoke Brick Company, Gallion Rustic



Congruent Dark Metalwork tone

KEY

Light



Dark



Medium



White

(detailing only)

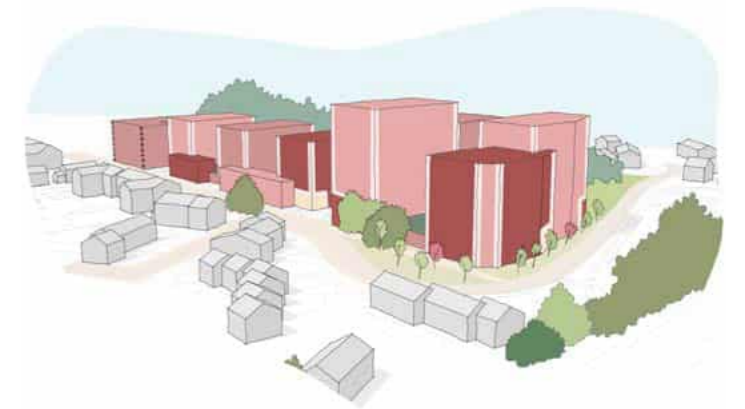

6.4 CHARACTER AREAS

6.4.1 Character areas, marker building and elevational hierarchy strategies

CHARACTER AREAS

The Design Code identifies a number of distinct character areas and street types, primarily shaped by their immediate context. Beyond considerations of built form, scale, and landscape design, specific elevational detailing further enhances the unique character of each area.

MARKER BUILDING

As outlined in the Design Code, a marker building is strategically placed at the corner of the proposed pedestrian connection to Hitherbroom Park. This building functions as a key way-finder, and in addition to its notable height, specific elevational considerations have been incorporated to generate visual interest.

ELEVATIONAL HIERARCHY

The Design Code establishes a clear hierarchy of elevations, prioritizing those facing Avondale Drive / Abbotswood Way and the park edge. This approach dictates a more elaborate design along primary elevations and a simpler treatment for secondary elevations. Furthermore, this hierarchy directly correlates with changes in character areas, influencing the level of detailing applied at ground floor and the consistency with which the elevational language, particularly window grids, is implemented.

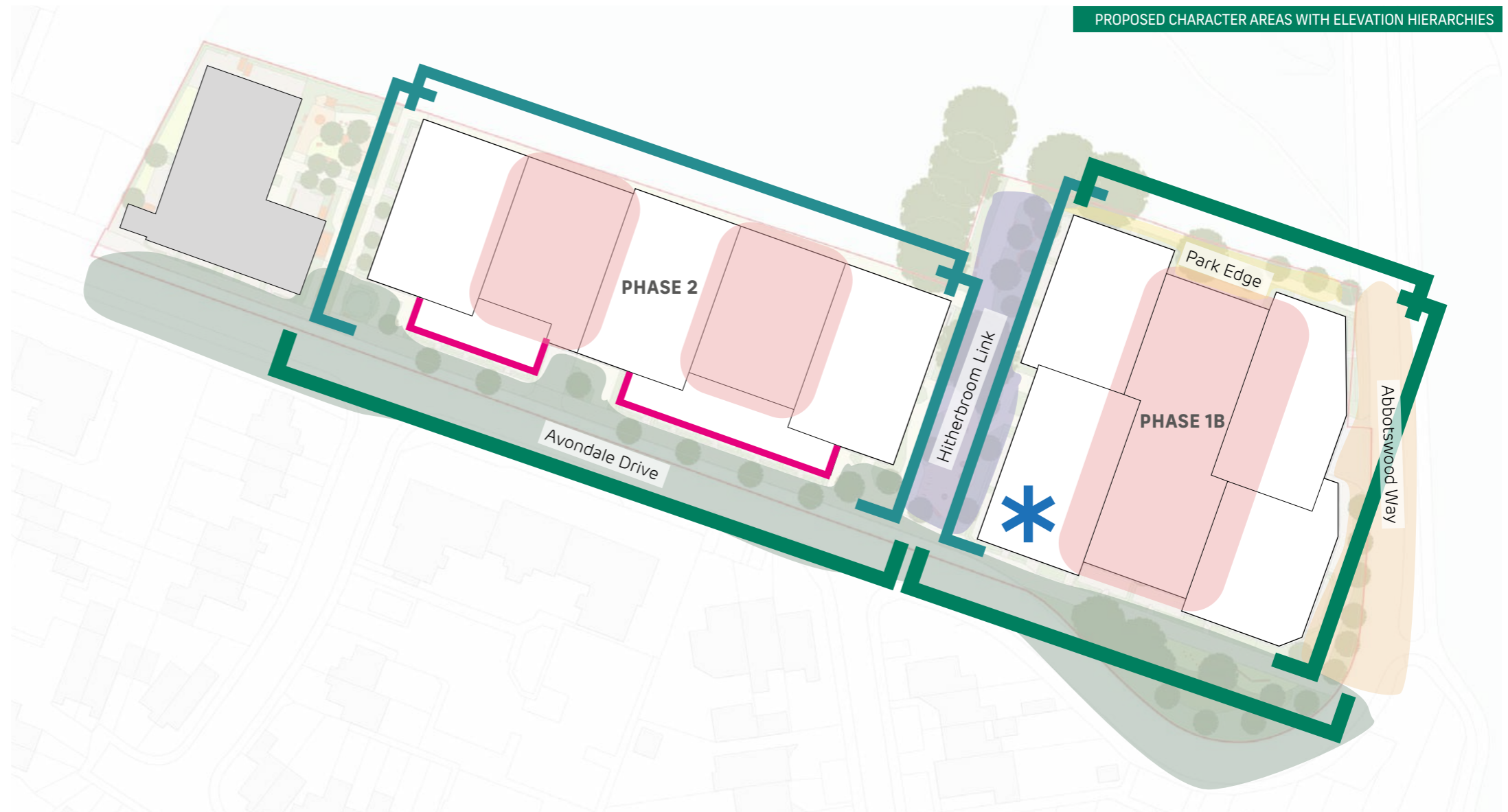

PROPOSED CHARACTER AREAS WITH ELEVATION HIERARCHIES

1. Avondale Drive



2. Abbotswood Way



3. Hitherbroom Link



4. Park Edge



5. Courtyard

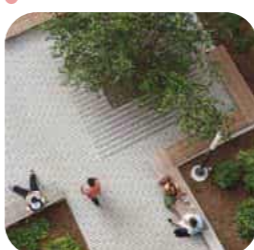

- Key**
- █ Primary Elevation
 - █ Secondary Elevation
 - █ Phase 2 Duplexes
 - ✱ Marker Building

- Character Areas / Street Types**
- █ Avondale Drive
 - █ Abbotswood Way
 - █ Hitherbroom Link
 - █ Park Edge
 - █ Courtyard

- A / 042-45
- A / 100
- M / 006
- M / 146

CHARACTER AREAS

6.4.2 Avondale Drive

1. Avondale Drive



BUILDING FORM AND TYPOLOGIES

The massing strategy for RMA rigorously follows the design principles established at the outline stage. To maintain Avondale Drive's established suburban residential character, two-storey duplexes, each with private front gardens and independent entrances directly from the footpath, are proposed. Complementing these, six-storey mid-rise apartment buildings are strategically recessed from the street frontage, thereby creating visual diversity and sensitively responding to the existing architectural context across the street.

TOWNSCAPE APPROACH

The Design Code identifies two key corners along Avondale Drive: South-East and South-West. Residential lobbies are strategically located at these points, benefiting from heightened visibility. Furthermore, a distinctive projecting corner balcony is proposed above each lobby, serving as a canopy and enhancing visual interest.

BUILDING FRONTAGES AND ELEVATIONS

Facade treatments, including window patterns, balcony designs, and brick colour/detailing, collectively enhance the building's character. Architectural detailing at the corners refines the edges of the mid-rise buildings and wraps around the corner lobby entrances. Recesses between duplexes accommodate rainwater pipes (RWPs) and delineate individual units. An alternating pattern of light and dark bricks, configured to subtly reflect the pitched

roof forms, visually scales down the duplexes and introduces a playful yet sophisticated aesthetic to the scheme.

Three primary brick colours are proposed:

The west group of duplexes features dark brick, contrasting with the light/medium-coloured mid-rise buildings behind.

The east group of duplexes utilises light brick, paired with medium and dark-coloured mid-rise buildings.



6.4.3 Abbotswood Way

2. Abbotswood Way



BUILDING FORM AND TYPOLOGIES

The stepped and chamfered building form along Abbotswood Way closely follows the existing road, maintaining a consistent and well-defined streetscape.

TOWNSCAPE APPROACH

The Design Code identifies the corner where Abbotswood Way meets Avondale Drive as a key focal point. A chamfered corner is proposed here to facilitate a smooth transition and to enhance pedestrian wayfinding. This design is further enhanced by distinct brick colours and refined edge detailing.

BUILDING FRONTAGES AND ELEVATIONS

Contrasting dark and light bricks are used to visually separate these two interlocked forms. The main lobby entrance is recessed from the street, with the massing above forming a canopy. On the northern corners, two-storey duplexes are proposed on the ground floor, offering views onto Hitherbroom Park. Vertical edge detailing wraps around these entrances and the ground floor duplexes, creating a cohesive aesthetic.



CHARACTER AREAS

6.4.4 Hitherbroom Link

3. Hitherbroom Link



BUILDING FORM AND TYPOLOGIES

The proposed pedestrian connection, which leads directly to Hitherbroom Park, is framed by a series of buildings: a 6-storey building to the west, an 8-storey building to the northeast (facing the park), and a 10-storey building set further back to the southeast corner, acting as a way-finder from Avondale Drive. This space is well-defined and activated by ground-floor Wheelchair apartments, each featuring its own private garden.

TOWNSCAPE APPROACH

The stepped form of Block E breaks up what would otherwise be a long facade, creating additional play space to the south that benefits from ample daylight and sunlight. The 10-storey building to the south serves as a visual landmark for way-finding, while the 8-storey building to the north helps define Hitherbroom Park while minimizing overshadowing.

BUILDING FRONTAGES AND ELEVATIONS

The architectural language of the elevations continues to wrap around from Avondale Drive. Both southern corners are highlighted by the lobby and a duplex unit, featuring vertical white brick detailing. The entrance to Block E is strategically positioned where the building steps, and is emphasized by distinctive linear brick detailing. Most projecting balconies facing this space are designed to foster engagement with the ground-floor play area, while also offering a side view of the park.

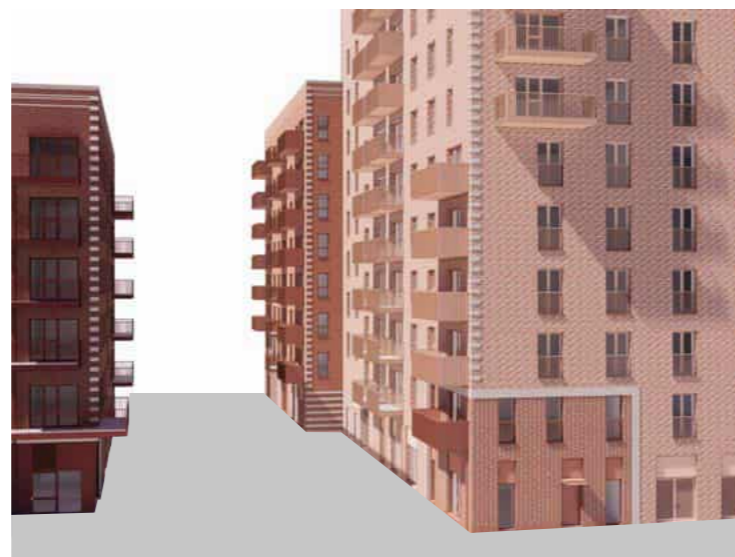

6.4.5 Park Edge

4. Park Edge



BUILDING FORM AND TYPOLOGIES

Four ground-floor duplexes, located beneath the apartment blocks, provide much-needed active frontage overlooking the park. A single podium, situated between these blocks, is set back to preserve an existing tree. The communal cycle store is proposed here, creating a semi-active frontage element.

TOWNSCAPE APPROACH

The narrow elevation of the apartment block facing the park defines the park edge without creating an overwhelming scale. A significant gap between the buildings, connected only by a single-storey podium, maintains a visual connection between the park and Avondale Drive. This also offers a sense of openness and enhanced views of the sky.

BUILDING FRONTAGES AND ELEVATIONS

Dark brick with a detailing pattern distinguishes the ground-floor duplexes, highlighting them against the lighter and medium-toned brick of the apartment blocks above. Linear brick detailing is used to facilitate this colour transition. A planting bay is proposed in front of the podium to support climbing plants, allowing them to cover the blank facade. This extends the green aesthetic from the park onto the podium landscape, offering both visual and ecological benefits.



CHARACTER AREAS

6.4.6 Courtyard

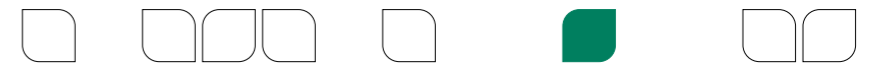

5. Courtyard



BUILDING FORM AND TYPOLOGIES

The proposed building heights and their strategic distances are carefully calibrated to ensure the courtyard is optimally lit with daylight and sunlight, effectively sheltered from wind, and thoughtfully landscaped to serve as the residents' primary communal amenity space, offering a convenient doorstep play area for younger children.

TOWNSCAPE APPROACH

The proposed design deliberately shapes the courtyard spaces: two sides are defined by mid-rise buildings, while the remaining two sides are either open to the sky or feature single-storey structures to preserve expansive outward views.

BUILDING FRONTAGES AND ELEVATIONS

The cohesive architectural language of the elevations seamlessly wraps around from Avondale Drive. All cores provide direct access to the courtyard's communal amenity space. Homes fronting the courtyard are provided with private gardens with buffer. The majority of projecting balconies are optimally oriented towards the courtyard, overlooking the play space below, and also offer secondary views towards either the street or the park. Balcony balustrade materiality (whether solid or railing) is determined in response to wind studies, ensuring optimal wind comfort on all balconies.

6.5 FENESTRATION

6.5.1 Window Types

PROPOSED WINDOW TYPES

Starting with the window sizes used on phase 1A, of which a selection are shown here, the proposed window types follow similar widths and sizing with similar mullion patterns, helping to further relate the architecture language between the different phases of the Outline development.

A consistent transom height of 1100mm has also been used, meeting recommendations in Approved Document K of the Building Regulations.

The colour of the frame of each window will be consistent with the metalwork for that block as outlined on the previous page.

Due to changing site factors affecting where windows can be cleaned externally or where they will need to be cleaned internally in a safe manor, variations on the 3 main window types are created, allowing for safe internal cleaning with adequate protection from falling designed in from the outset where necessary.

Further details on the cleaning and maintenance strategy are provided under section 7.8 of this document.



SELECTION OF PHASE 1A FENESTRATION TYPES

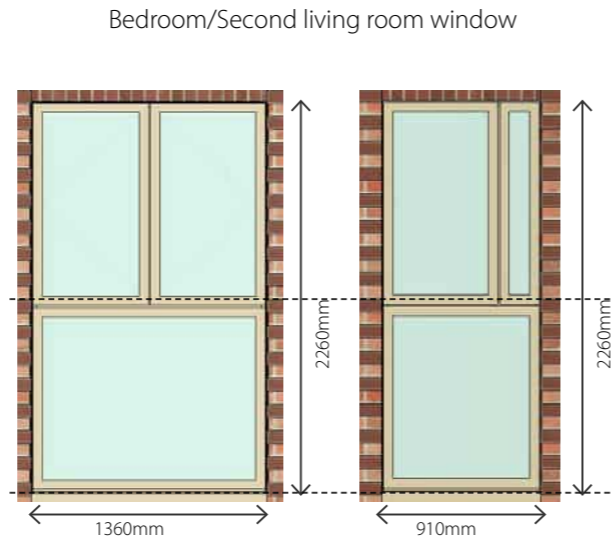

Bedroom window (used on East/West facades. Also used as secondary window to some living spaces)



Bedroom window with Juliet (without Juliet on ground floor or onto balconies/terraces)

PHASE 1B AND 2 PROPOSED FENESTRATION TYPES

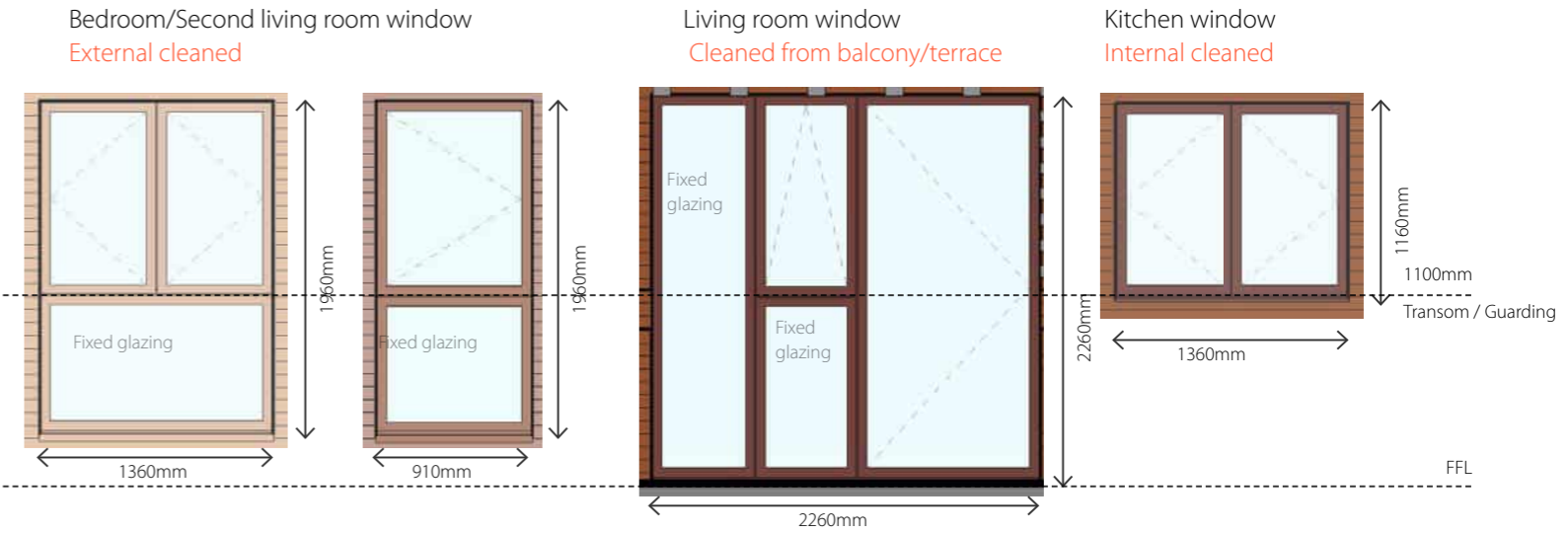

Bedroom window (used on East/West facades. Also used as secondary window to some living spaces)
 Single bedroom window / secondary living space window / staircase window
 Duplex Living space window (opening on to terrace at ground or podium levels)
 Kitchen window (over the kitchen worktop) Same as Phase 1A

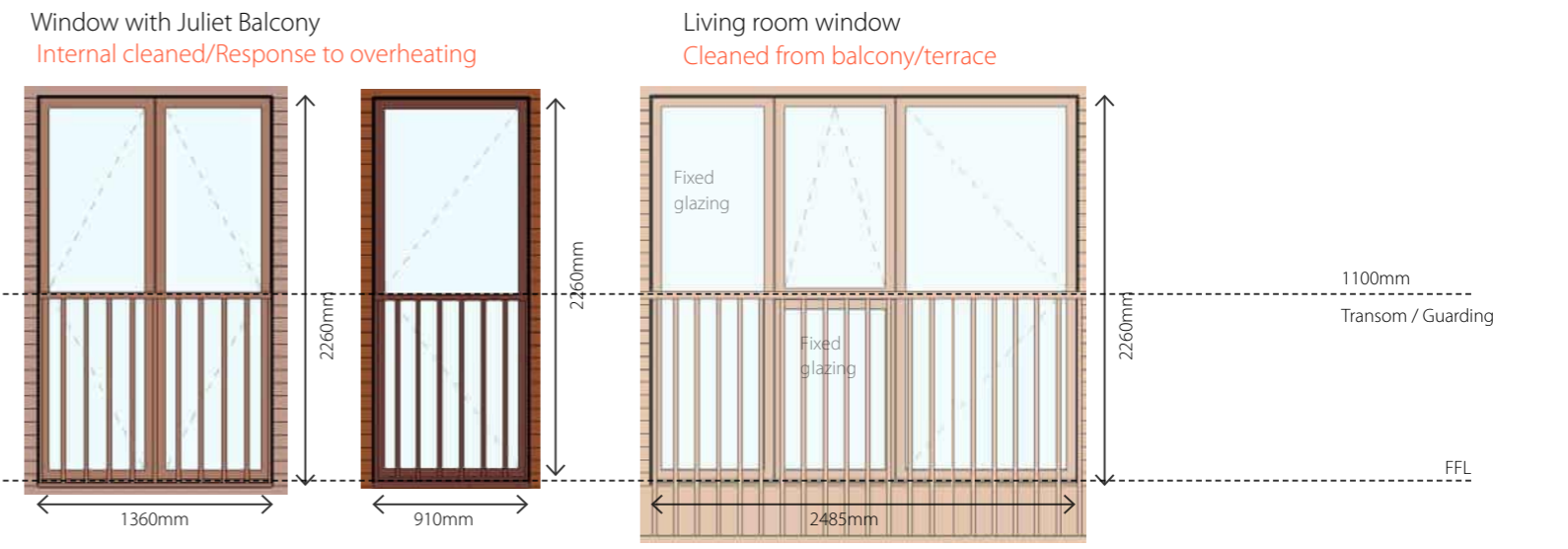

Bedroom window with Juliet (without Juliet on ground floor or onto balconies/terraces)
 Single bedroom window (without Juliet on ground floor or onto balconies/terraces)
 Living space window (opening on to balcony on upper floors / terrace at ground or podium levels)

A / 058-59

M / 057

M / 074

FENESTRATION

6.5.2 Window Spacings

APPLICATION TO KEY SOUTH ELEVATION

The elevation adopts a disciplined yet adaptable fenestration strategy that balances rhythm, scale and functionality across the mid-rise and duplex elements, in accordance with the character area and strategy for elevational hierarchy.

A simple, ordered bay system is established by a sequence of vertical piers whose spacing is subtly graded to reduce perceived mass and to articulate the elevation in response to internal layouts. This modulation produces a clear street rhythm while allowing varied window proportions to read as part of a coherent whole.

Key features:

- Juliet balcony windows on the mid-rise blocks facing south and north: principal living/bedroom windows are paired with slim, integrated Juliet balustrades. These provide a safe external connection, enhance façade depth through reveal and shadow, and allow full-height glazing where appropriate without projecting balconies, which also helps with the overheating. Balustrade detailing is metal and recessed into the window reveal to maintain a clean line and ensure longevity.
- Slim vertical windows for duplexes: duplex living/bedroom are expressed using narrower windows whose proportions read to the scale of the two-storey volumes. These slender openings emphasise verticality, provide controlled solar gain and natural ventilation, and sit comfortably between the piers to create a refined sub-scale within the streetscape.
- Fixed bottom-panel windows to courtyard elevations in Phase 2: where privacy and resilience are paramount, windows facing the courtyard incorporate a fixed lower panel with an operable upper light (or top-hung opener). Glazing heights and sill levels are coordinated to respect internal furniture layouts and to preserve outlook to amenity spaces.

Together, these measures ensure the proposed elevation reads as a coherent, high-quality composition: a clear structural rhythm of piers and bays providing legibility, with carefully calibrated window types that respond to the differing spatial, privacy and maintenance requirements across the phase.

PHASE 1A (BUILT)

PHASE 2

PHASE 1B



Balcony on corner facing the south to mitigate the overheating/create the interest along main facade

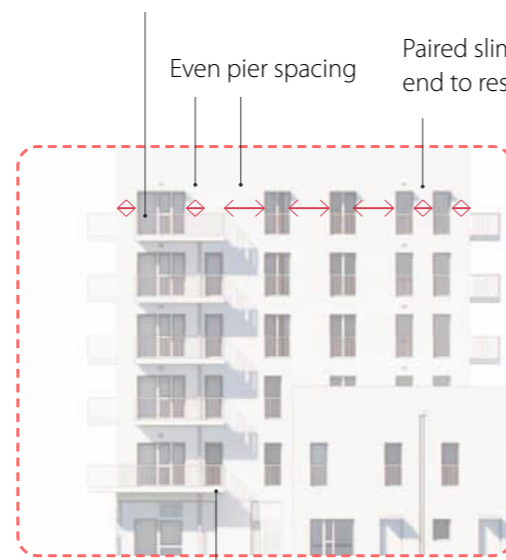

Corner balcony on first floor above the entrance lobby

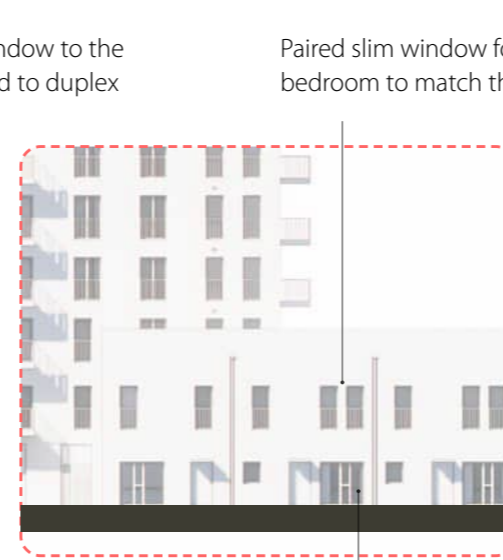

Smaller living room window to match the scale

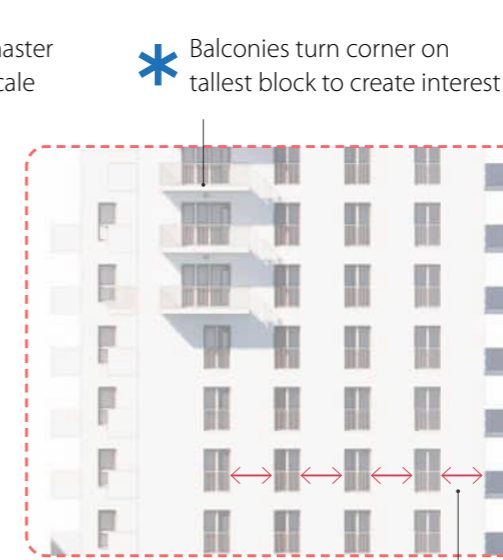

Even pier spacing

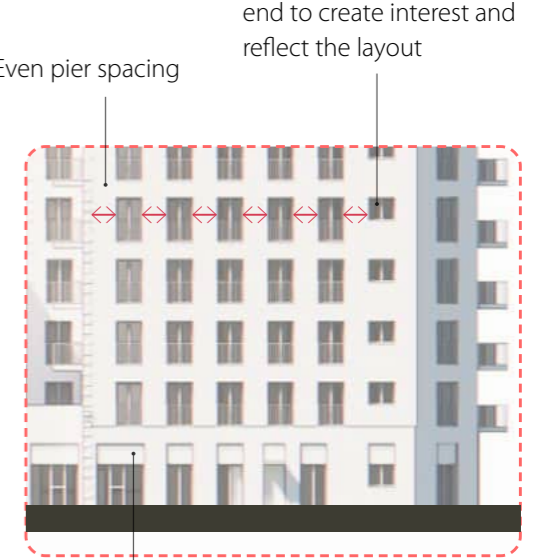

Head panel to Ground Floor windows



A / 058-59

M / 057

M / 074

6.6 ELEVATIONAL DETAIL ELEMENTS

6.6.1 Rainwater pipes and balcony drainage

BALCONY DRAINAGE STRATEGY

Balconies and their drainage are coordinated to provide private external amenity, enrich key elevations, assist passive cooling (mitigating overheating), protect the façade and safeguard pedestrians. The strategy for projecting balconies combines positive falls to concealed outlets, discreet downpipe routing integrated into the elevation, and free-draining balustrade details where appropriate.

Principles:

- **Positive fall:** Balcony decks are formed with a minimum fall to discharge (typical minimum 1:80) to avoid standing water and promote rapid runoff.
- **Positive drainage at vulnerable locations:** Balconies above entrances or high-use routes discharge to dedicated linear gutters or downpipes, with secondary overflow connections to the primary gutter/RWP network to protect thresholds and lobbies.
- **Free-draining upper balconies:** Where balconies are not positioned above circulation or entrances, balustrade details (open joints or discreet weep slots) allow water to fall clear. These are located and detailed to prevent splash on paths and to meet pedestrian safety standards.
- **Integration with SUDS/site drainage:** Where feasible, rainwater from balcony RWPs will be routed into the site's sustainable drainage/attenuation network in line with the overall drainage strategy; final routing to be confirmed with the drainage engineer and the local authority drainage officer.
- **Detailing and maintenance:** Outlets, leaf-guards and overflows are specified to reduce blockage and staining; downpipes are colour-matched and kept visually discreet on principal façades. Access points for rodding/cleaning are provided at podium/ground level to ensure long-term performance.

BLOCK B ENTRANCE



FIRST FLOOR PLAN

Key

- Positively drained balconies
- Free-drained balconies

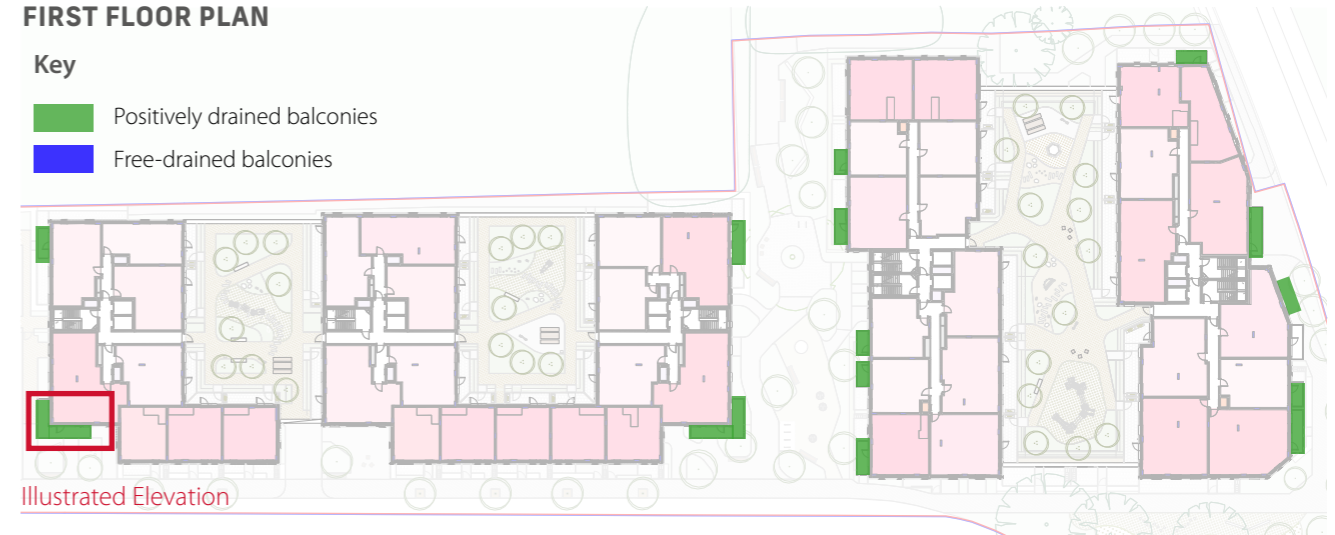

Illustrated Elevation

SECOND FLOOR PLAN

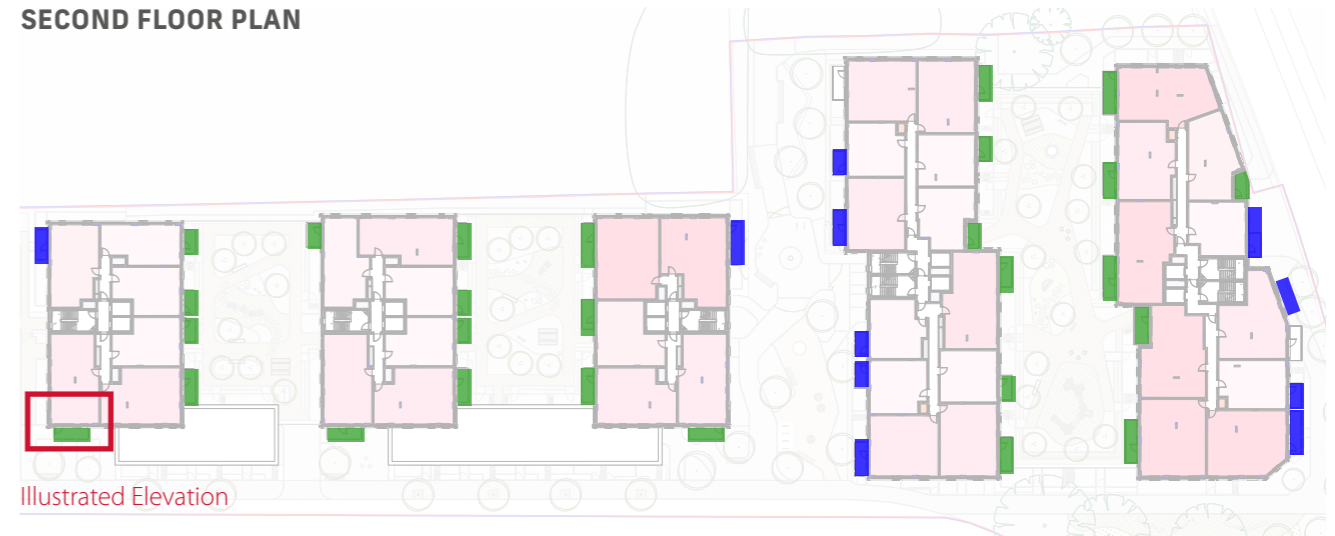

Illustrated Elevation

TYPICAL FLOOR PLAN

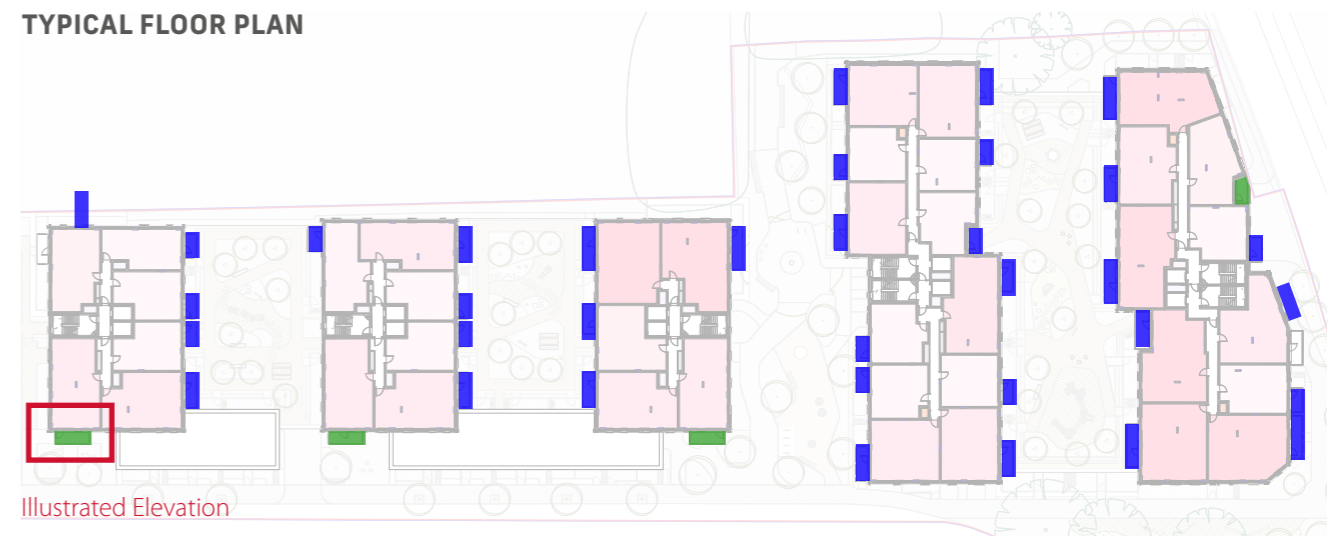

Illustrated Elevation

6.7 ARCHITECTURAL DETAILS

6.7.1 Corner expression

CORNER DETAILING

The conceptual intention for the corner detailing is to emphasise the verticality of the mid-scale and taller blocks, and to add architectural richness to the design. This proposed detailing wraps entrances/duplexes at lower levels to express a change in use/typology, and continues to the top of each block, terminating with a specific top finishing detailing.

This is achieved in a detail design that very closely replicates that which is built on phase 1A, providing a strong contextual basis for its inclusion. Bands of stretcher bond white brick are stacked in groups of 3 and then alternated with the main brick. As this detailing is proposed in a consistent colour regardless of the main block colour it sits on, the starkness of contrast will vary across the blocks. Each white brick grouping will project out from the main facade by a nominal amount, similar to phase 1A, adding further richness to this corner detail.

Key corners are enriched with wrapping of entrances/duplexes at lower levels. The chamfered key corner's massing change is also further expressed with a brick tone change

SOUTH ELEVATION



NORTH ELEVATION



Key

- Key corner with expressed entrance wrapping detailing
- Key corner with expressed duplex wrapping detailing
- Standard Corner detailing
- Chamfered corner with unique expression

PHASE 1A CORNER AND TOP DETAILING



CONCEPT

Vertical expression on the corners with entrances and duplexes expressed

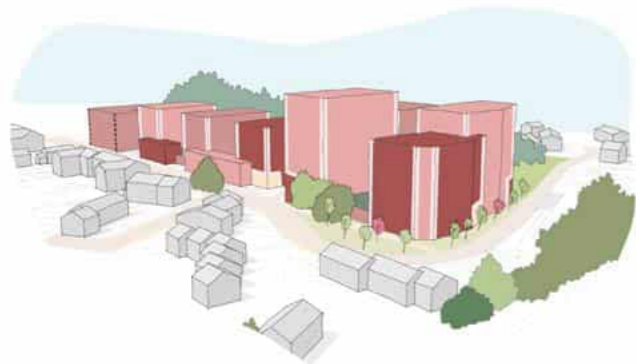

TYPICAL CORNER DETAILING

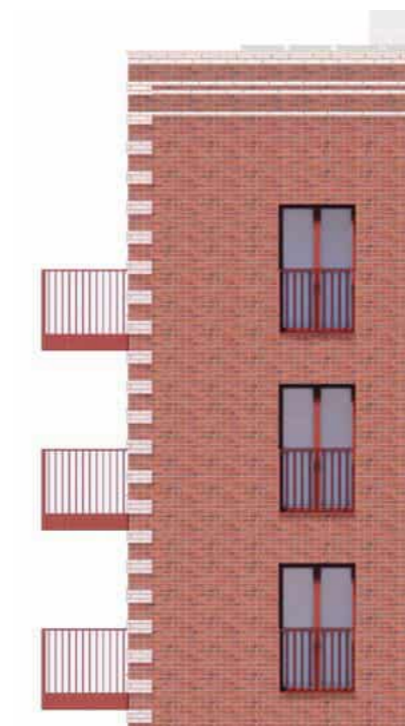

KEY CORNER WRAPPING ENTRANCE



KEY CORNER WRAPPING DUPLEX



KEY CHAMFER CORNER



A / 007-10

A / 055

A / 069

M / 006

M / 051-52

M / 057

ARCHITECTURAL DETAILS

6.7.2 Marker Building

MARKER BUILDING DETAILING

The marker building applies all the same architectural detailing rules as the rest of the development; corner detailing along the edges of the block, wrapping details around duplexes/entrances which are further expressed with a brick tone change, and horizontal detailing at the top of the block in a similar style of match phase 1a.

In addition to this, the status of the marker building is further emphasised by a turn of balconies on the key corner, which elsewhere in the scheme always stack up the facade. This change will be visible from long distances, marking the development from a townscape perspective.

Along the south elevation, as a primary facade, there are strict window spacings and minimal visible air bricks, which are located on other facades, where possible.

SOUTH ELEVATION OF MARKER BUILDING



White horizontal brick detail at top of block

White vertical brick detail to frame edges of block

Minimal air bricks located on key facade of marker building

Even window spacing

Stacking balconies turn the corner / swap elevations on the key corner of the marker building.

Juliet balconies for visual interest and to help mitigate overheating by increasing openable window area

Wrapping corner detail used to express duplex

Change of material to express duplex

A / 007-10

A / 069

M / 006

M / 057

ARCHITECTURAL DETAILS

6.7.3 Phase 2 Duplexes

DUPLEX DETAILING

The elevation adopts a disciplined, warehouse-inspired language that reads as a row of individual houses within a coherent terrace. Robust brickwork and carefully calibrated details create texture, vertical rhythm and a clear base-to-top composition that sits comfortably in the wider scheme.

Key elements

- Hit-and-miss brick coursing: a mix of dark and light bricks introduces subtle tonal variation and shadow without applied ornament.
- Vertical reveals and RWPs: narrow shadow gaps define individual units; rainwater pipes are discreetly located within these reveals and colour-matched to the metalwork to reinforce the vertical cadence.
- Soldier courses: a soldier course crowns the parapet and a second course at transom level provides a consistent horizontal datum and ties window proportions together.
- Dark brick plinth ("socks"): a solid darker brick base anchors the building, resists pedestrian-level wear and gives the terrace a confident grounding.
- Entrances and small-scale features: modestly recessed doors with simple metal canopies create a sheltered, human-scale threshold.
- Window and jointing strategy: slim metal frames, consistent reveal depths and narrow mortar joints unify the varied brickwork and ensure a refined, durable finish.

Together these measures produce a textured, well-proportioned two-storey terrace that is materially robust, legible at street level and consistent with the masterplan's brick language.

BRICK DETAILING PRECEDENT



Highgate Newtown Community Centre by RCKa (HDA 2025 winner)

DUPLEXES ELEVATION



Brick detailing stops at angles to express individual homes, and add balance to the top of the parapet

PLAN

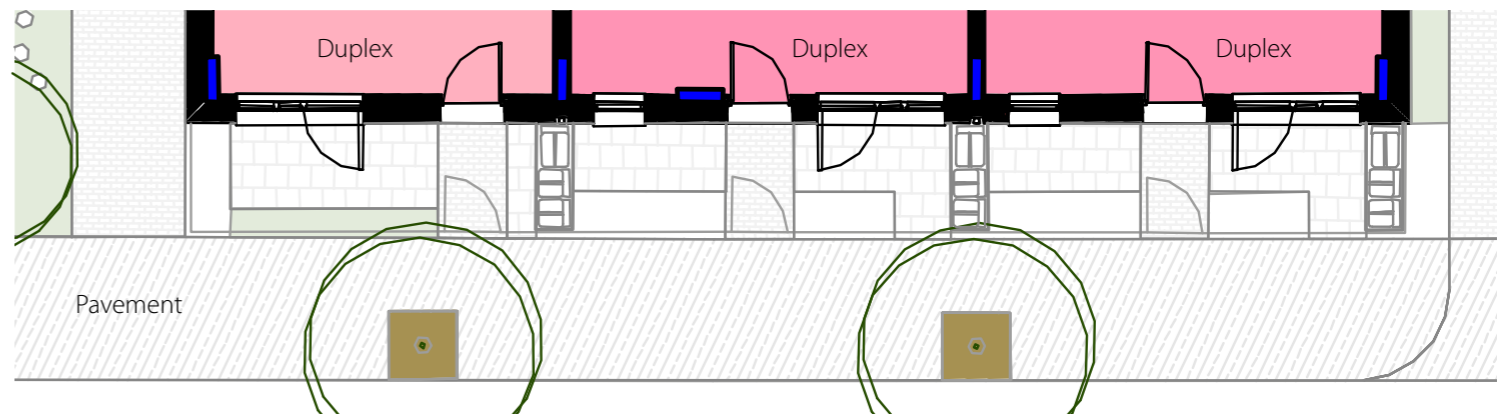

Brick headers above windows

- Shadow gap between the duplex
- Juliet balconies on first floor
- External RWP in the shadow gap
- Simple canopy to the entrance
- Mixed dark and light brick detail to add texture
- Soldier course

A / 007-10

A / 069

M / 057

ARCHITECTURAL DETAILS

6.7.4 Block B/D Entrances

ENTRANCE DETAILS

All the lobby entrances use curtain walling to highlight the entrance for wayfinding purposes. On the Phase 2 corners, this returns around the corner of the building, creating dual aspect glazing with better visibility and potential signage opportunities. All curtain walling will be set back from the main facade, creating depth to the elevation.

The corner entrances are further signposted by the feature corner balconies proposed to wrap around the top of the curtain wall, following a line of horizontal white brick that also frames the curtain wall. The corner balconies provide additional benefits, shading the entrances and helping to mitigate overheating as well as offering rain protection.

3D PERSPECTIVE



Corner balcony

PLAN

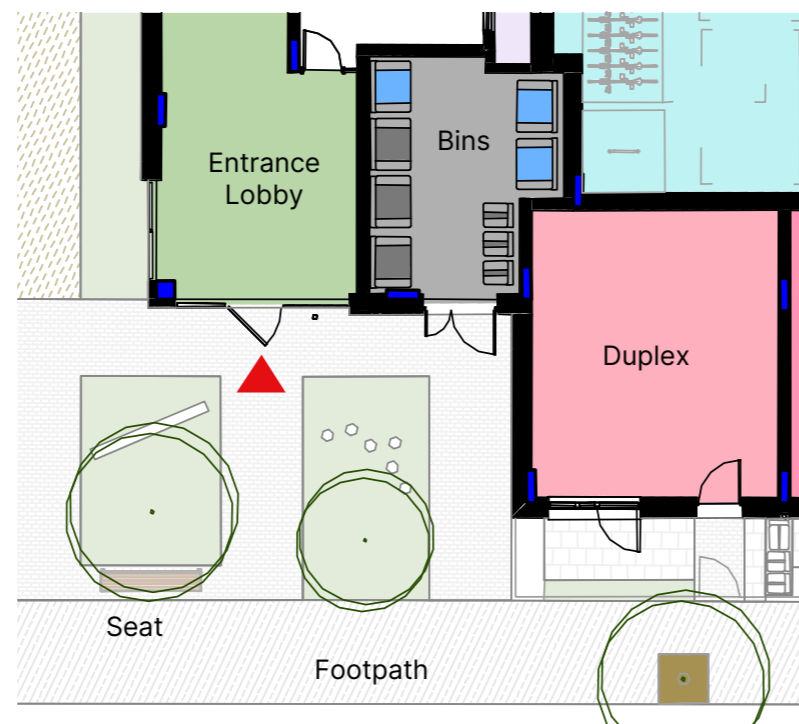

ELEVATION



Corner balcony

- A / 007-10
- A / 055
- A / 069
- M / 051-52
- M / 057

6.8 PROPOSED BAY STUDIES

6.8.1 Duplexes

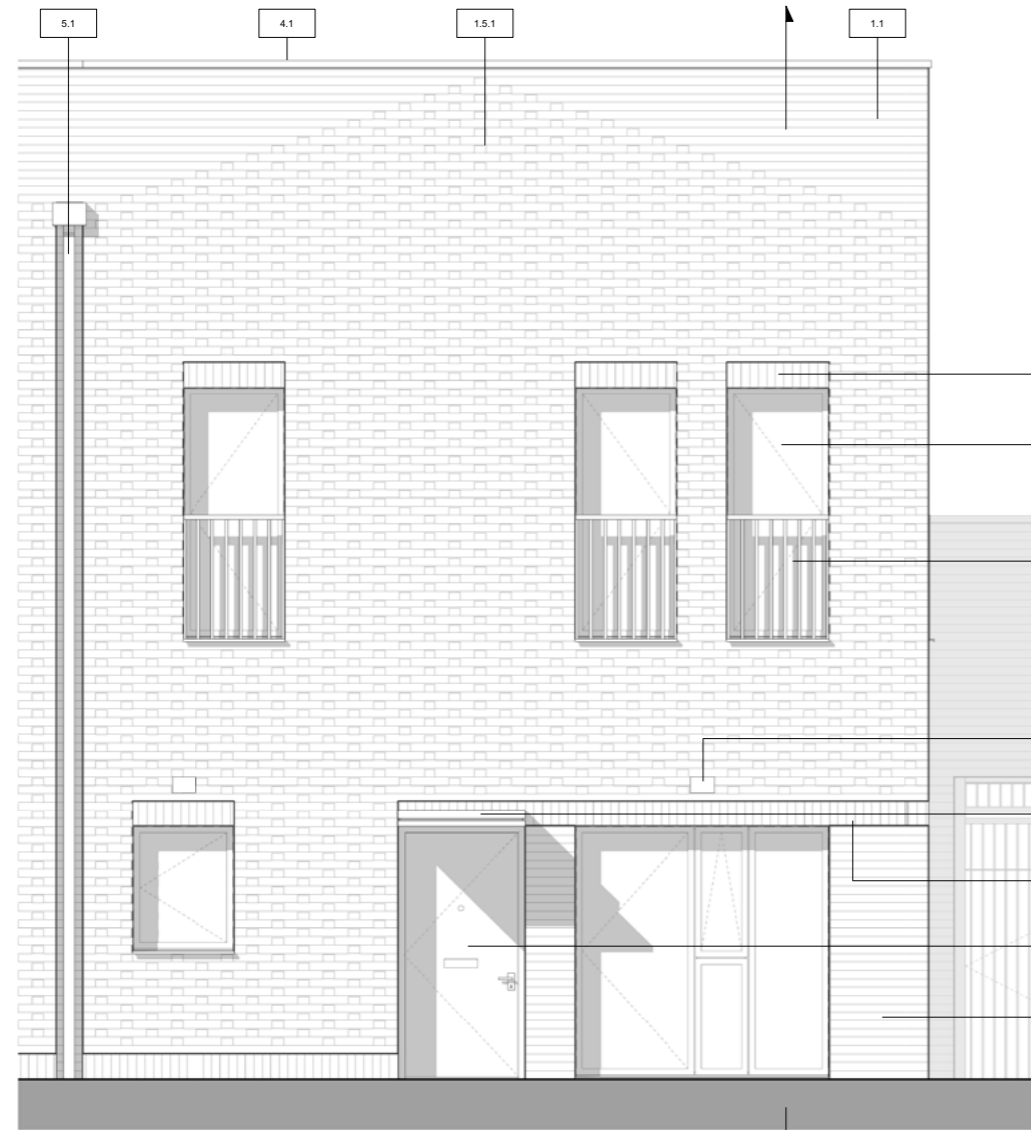
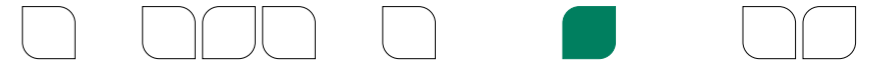

Bay Study_Ph2 Duplex Front Elevation
1:25

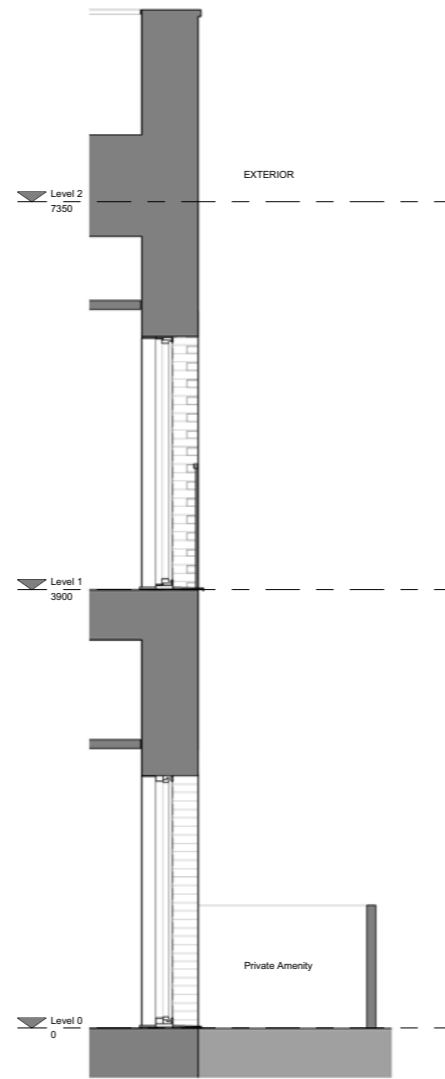

Bay Study_Ph2 Duplex Section
1:25

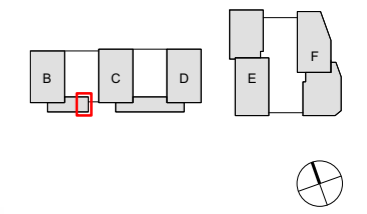

Bay Study_Phase 2 Duplex Axonometric

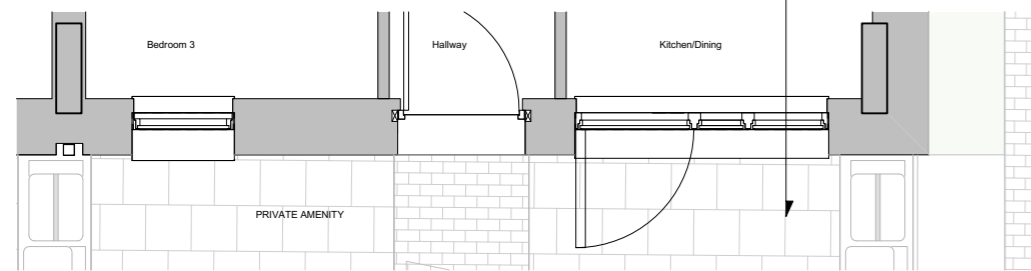

Bay Study_Ph2 Duplex GF Plan
1:25

Keynote Legend	
Key Value	Keynote Text
1.1	Dark red-toned Brick
1.1.1	Dark red-toned Brick Soldier Course
1.5.1	Dark red-toned Brick with Light red-toned Brick Pattern
2.1.1	Metal Juliet Balcony, dark colour
3.1	Composite window/door frame, dark colour
3.7	Solid/louved door, dark colour
4.1	Metal Coping, dark colour
4.4	Metal Canopy Entrance, dark colour
5.1	RWP, dark colour
5.4	Air Brick, dark colour

To be read in conjunction with detailed material descriptions in Design & Access Statement

- A / 053
- A / 069
- A / 088
- M / 057
- M / 064-65

PROPOSED BAY STUDIES

6.8.2 Block D Entrance

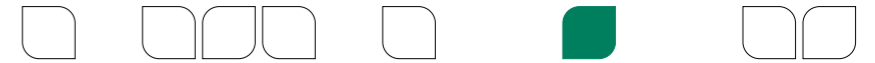

Bay Study_Block D Entrance Front Elevation
1:25

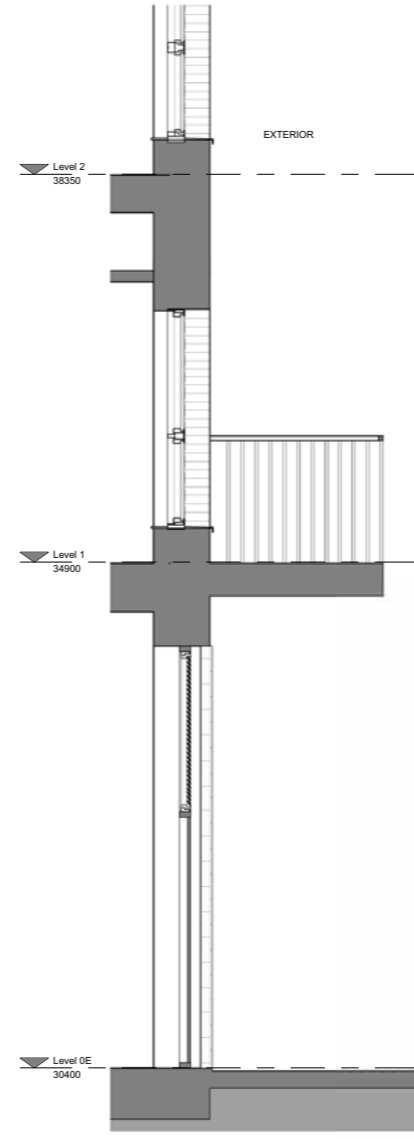

Bay Study_Block D Entrance Section
1:25



Bay Study_Block D Entrance Axonometric

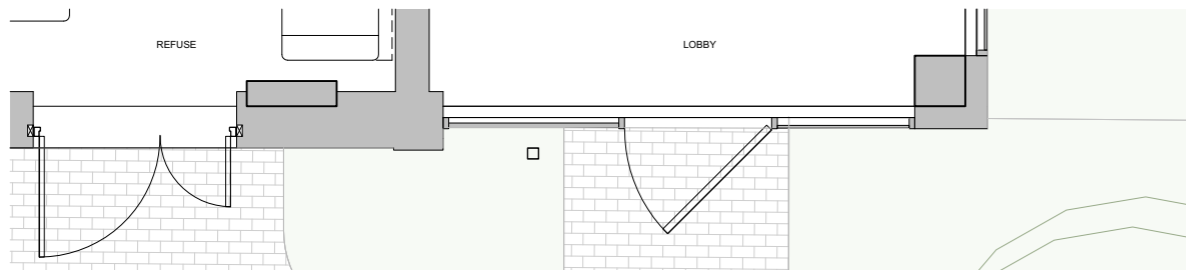
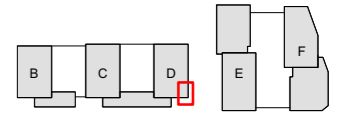
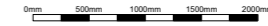

Bay Study_Block D Entrance GF Plan

Keynote Legend	
Key Value	Keynote Text
1.1	Dark red-toned Brick
1.4	Pale Brick
1.4.2	Projecting Pale Brick Corner Detail
2.1	Metal balcony, dark colour
2.1.1	Metal Juliet Balcony, dark colour
3.1	Composite window/door frame, dark colour
3.4.1	Solid/louvred metal panel, dark colour
3.6	Curtain wall glazing/door frame, light colour
3.7	Solid/ louvred door, dark colour
5.1	RWP, dark colour
5.4	Air Brick, dark colour

To be read in conjunction with detailed material descriptions in Design & Access Statement

- A / 007-10
- A / 053
- A / 055
- A / 069
- A / 088
- M / 051-52
- M / 057
- M / 064-65

PROPOSED BAY STUDIES

6.8.3 Block F Entrance



Bay Study_Block F Entrance Front Elevation
1:25

Bay Study_Block F Entrance Section
1:25

Bay Study_Block F Entrance GF Plan
1:25

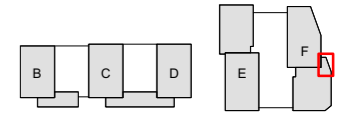
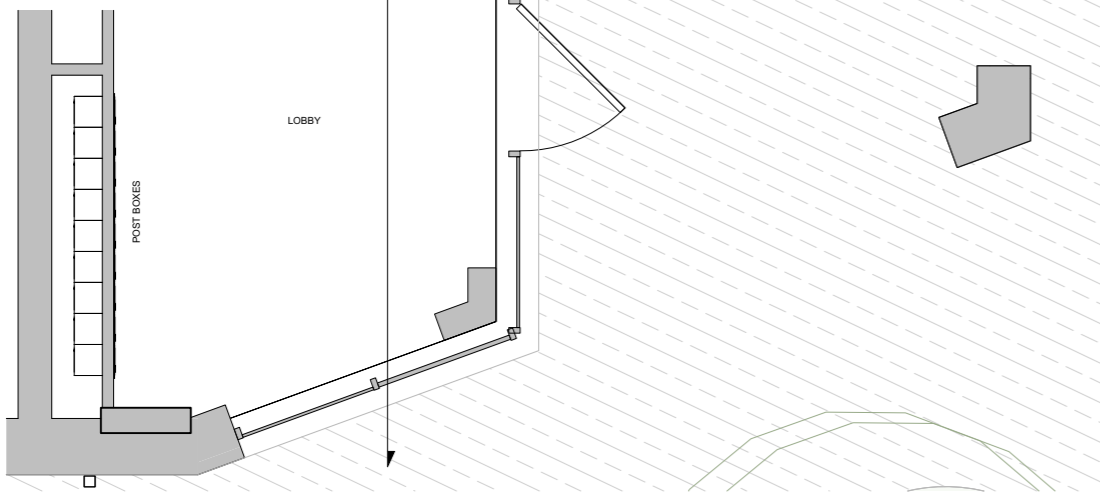

Bay Study_Block F Entrance Axonometric

Keynote Legend	
Key Value	Keynote Text
1.1	Dark red-toned Brick
1.4	Pale Brick
1.4.2	Projecting Pale Brick Corner Detail
2.1.1	Metal Juliet Balcony, dark colour
2.1.2	Metal solid balcony, dark colour
3.1	Composite window/door frame, dark colour
3.6	Curtain wall glazing/door frame, light colour
3.6.1	Solid/louvred metal panel, light colour
5.1	RWP, dark colour
5.4	Air Brick, dark colour
5.8	Metal Panel Cladding, light colour

To be read in conjunction with detailed material descriptions in Design & Access Statement

- A / 007-10
- A / 053
- A / 055
- A / 069
- A / 088
- M / 051-52
- M / 057
- M / 064-65

PROPOSED BAY STUDIES

6.8.4 Blocks E and F

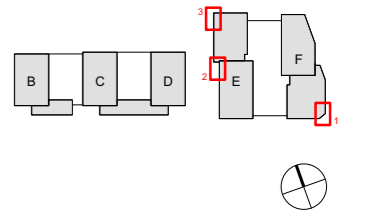

Bay Study_Block F Chamfer Corner Axonometric



Bay Study_Block E Entrance Axonometric



Bay Study_Block E Corner Duplex Axonometri

Please refer to planning drawings ending -23007, 23008 and 23009 for full details

- A / 007-10
- A / 053
- A / 055
- A / 069
- A / 088
- M / 051-52
- M / 057
- M / 064-65

6.9 PROPOSED SITE ELEVATIONS

6.9.1 South Elevation

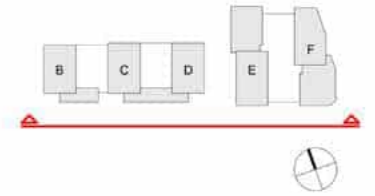
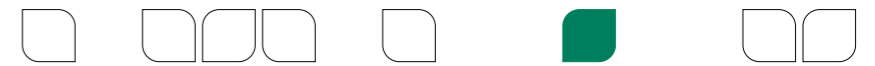

South Elevation
1:300

- A / 007-10
- A / 053-55
- A / 058-59
- A / 068-69
- A / 071
- M / 006
- M / 011
- M / 051-52
- M / 057
- M / 065

PROPOSED SITE ELEVATIONS

6.9.2 North Elevation

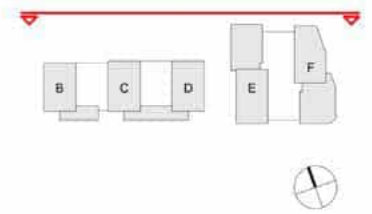

- A / 007-10
- A / 058-59
- A / 068-69
- A / 071
- M / 011
- M / 057
- M / 065

6.10 ILLUSTRATIVE VIEWS AND CGIS

6.10.1 View East along Avondale Drive

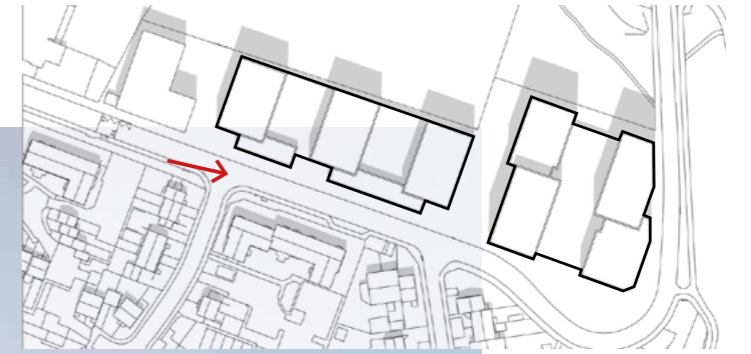
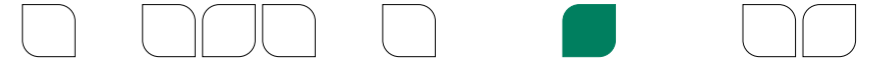

ILLUSTRATIVE VIEWS AND CGIS

View East along Avondale Drive

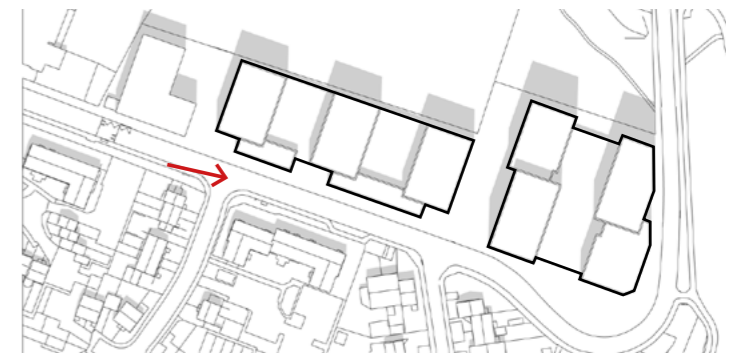

ILLUSTRATIVE VIEWS AND CGIS

6.10.2 View South along Abbotswood Way

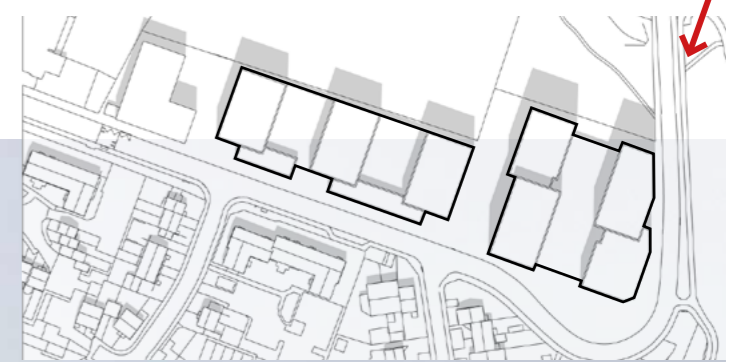
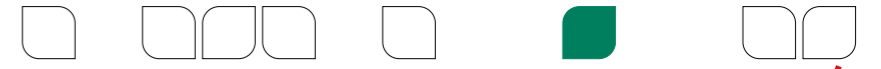

ILLUSTRATIVE VIEWS AND CGIS

View South along Abbotswood Way

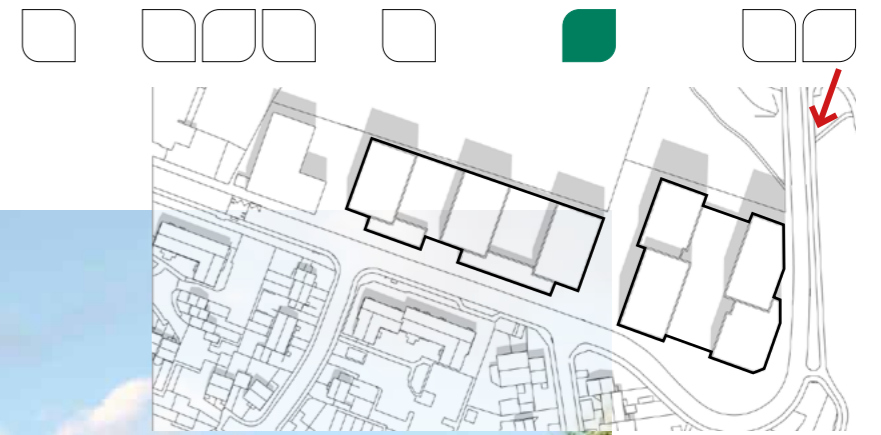

A / 012

ILLUSTRATIVE VIEWS AND CGIS

6.10.3 Block D Entrance

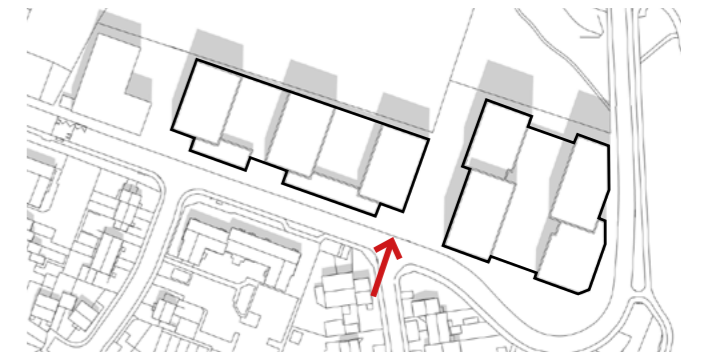
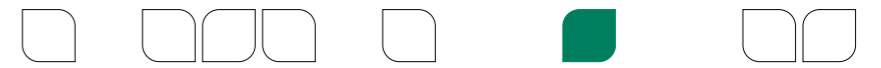

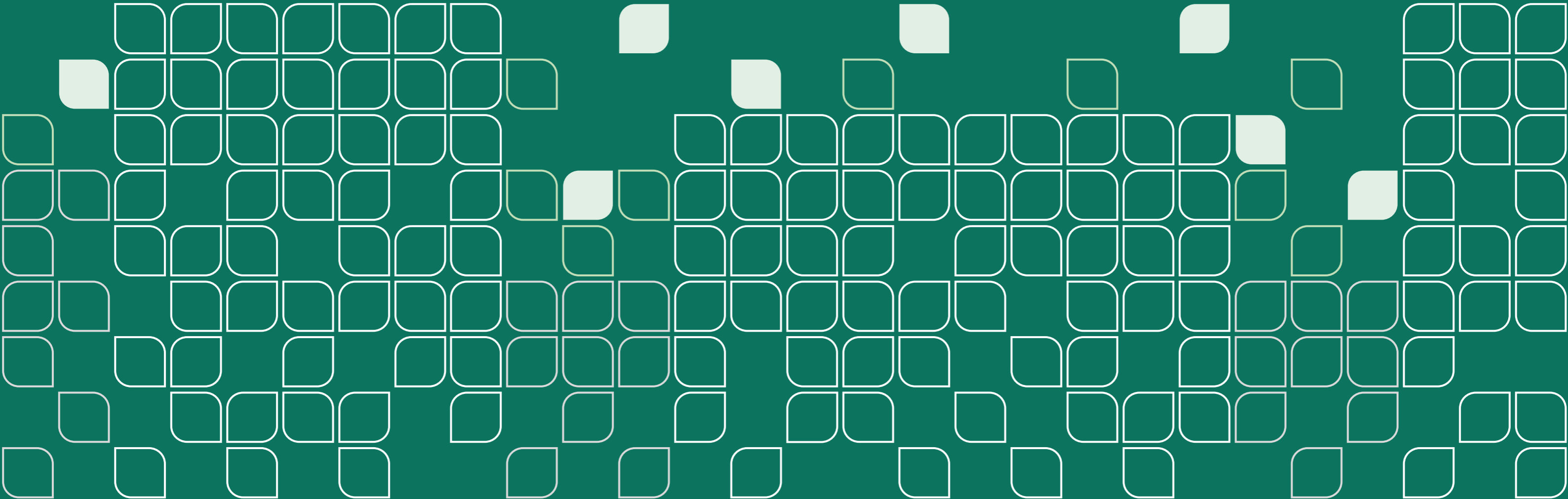

7. TECHNICAL CONSIDERATIONS

7.1 MEP, ENERGY & SUSTAINABILITY STRATEGY



MECHANICAL SERVICES - VENTILATION

Apartments:

MHVR (Mechanical Ventilation with Heat Recovery) will be installed to each apartment in a dedicated utility cupboard. This will be set to a minimum air change rate as defined by Approved Document F and controlled via a humidity sensor to provide a boost to ventilate the apartment at up to 1 ACH.

All bathrooms and WC's will be installed with extract valve grilles with supply valve grilles being provide to the living room and bedroom areas. The grilles can be used to balance the system within the apartment. The kitchens are to be installed with a re-circulating cooker hood to prevent grease entering the extract system with a separate grille installed connected to the mechanical ventilation system.

Landlords:

- Auxiliary fans will be provided as required to bin and bike stores.
- Car Park ventilation system to be design by specialist as mixed mode (natural and impulse fans).
- Car Park lobbies to cores to be ventilation naturally with a 0.4m2 duct.
- Corridor smoke venting will be provided via mechanical smoke shaft with AOVs. A staircase AOV will be provided for smoke clearance of the staircase and markup air.

HEATING AND COOLING

Centralised plant rooms are located on the roof of the buildings to provide district heating and district hot water to the dwellings.

The bulk of the heating will be delivered through the MVHR unit via a reversible coil. Electric panels will be installed to all rooms to provide top up if required and to enable different rooms to be set to different temperatures and to circulation areas. An interlock between the MVHR coil and electric panels is to be provided to ensure that the MVHR coil is always utilised first.

The coil will be reversed in summer to provide beneficial cooling to the dwelling to ensure the internal temperature does not exceed 26oC.

All bathrooms will have electric towel rails.

Heating and Cooling is to be metered via a heat meter. A prepayment metering system is to be installed such as Switch2. This system is also linked to the hot water system to record the consumption via a flow meter and CTs to the incoming electric to allow the tenant to view all energy consumption in one location.

Pre-insulated pipework is to be installed between the street and a location in the ground floor plant room to allow for the installation of future District Heating pipework. Space to be provided in this plantroom with a route set out to the roof plantroom to allow connection into the heating and hot water system. Space will be indicated on the drawings.

COLD WATER SERVICES

The cold-water distribution to the dwellings will be via a sectional water storage tank and packaged pressure boosting unit. Boosted cold water will be supplied to all sanitary fittings and items of equipment. An electromagnetic water conditioner will be fitted to the incoming mains water supply to the water storage tank.

A water storage tank will provide a buffer against supply interruptions. Water distribution through the building will be pressurised through an inverter drive controlled automatic water booster set.

A separate Category 5 water storage tank and booster set shall be provided for irrigation of the landscaping and to external water points around the site alongside cleaners sinks and bid taps for washdown of bin and bike stores.

A water meter will be provided for each apartment. These will be located within the risers at each floor level.

Metered mains water supply will be provided for Landlord use.

HOT WATER SERVICES

The domestic hot water provision will be met by the central district hot water system to each of the dwellings.

Thermostatic mixing valves will be used to reduce the risk of scalding, within allocated dwellings. All tenants will be metered through a flow meter which is read remotely.

Cleaner's cupboards or welfare facilities will be provided with instantaneous hot water heater.

The system will be designed to ensure hot water delivery with 45 seconds in line with CIBSE CP1 recommendations.

Pre-insulated pipework is to be installed between the street and a location in the ground floor plant room to allow for the installation of future District Heating pipework. Space to be provided in this plantroom with a route set out to the roof plantroom to allow connection into the heating and hot water system. Space will be indicated on the drawing.

DOMESTIC FOUL WATER DRAINAGE

All sanitary fittings will be connected to a modified single stack

system in accordance with BS EN 12056-2:2000. The pipework will be installed in uPVC for the stacks and branches.

Access will be provided at all branches, changes of direction and connections to horizontal runs.

Where baths are installed, the ability to convert to a shower connection will be designed in.

RAINWATER DRAINAGE

All roofs are to be drained via traditional gravity downpipes located internally. Balconies to be free draining where possible apart from over entrances..

All runs within ceilings and risers will be thermally insulated and vapour sealed to prevent condensation.

All rainwater pipes to be installed externally where possible. Where pipework is installed internally this will be installed in uPVC pipework. Internal rainwater pipework located in communal areas will not require any insulation. If rainwater pipework is installed with apartment, then pipework to be insulated against noise breakout.

Water butts to provided to ground floor dwellings.

The rainwater disposal system will be designed in accordance with BS EN 12056-3:2000.

All rainwater drainage will pass into a rainwater attenuation tank before reaching the public drain. Please refer to the Civil Engineer's information for details.

SPRINKLERS - RESIDENTIAL

Following the BS9251:2021, a Category 4 domestic sprinkler system will be provided to Phase 1b and Category 3 domestic sprinkler system to Phase 2.

A separate sprinkler tank and booster set is to be installed to serve the residential units including appropriately sized booster pumps. Sprinkler supply for will be for 60 minutes to meet the Cat 4 requirements and 30 minutes for Cat 3 The pumps for the Cat 4 system will be provided with secondary power supply.

SPRINKLERS - CAR PARK AND AUXILIARY AREAS

A separate commercial sprinkler system is to be installed to serve the car park and auxiliary areas such as bin and bin stores. This system is to be a category OH3 system and requires 140,000litres of stored water.

Currently one system per building is being installed.



SERVICES DISTRIBUTION

The proposed main services riser sizes have been identified and shown on the architects GA plans.

Distribution routes are generally concealed within ceiling voids and riser cupboards.

MEP, ENERGY & SUSTAINABILITY STRATEGY

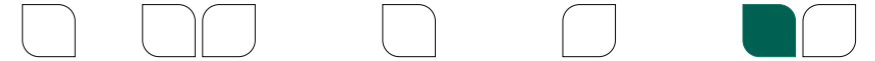

ENERGY & SUSTAINABILITY OVERVIEW

An Energy and Sustainability Statement has been prepared by Watkins Payne on behalf of the London Borough of Hillingdon ('LBH') in support of a reserved matters application for Land at Avondale Drive, pursuant to Condition 1 of the hybrid permission for the site. A Section 73 application (application ref: 76551/APP/2025/2861) is currently pending and will be determined prior to the approval of this Reserved Matters Application. Therefore, this RMA responds to the revised wording of the planning conditions proposed within the Section 73 application, which is set out in Condition 34.

The document presents the energy and sustainability strategy for the proposed development in line with the energy hierarchy and the local planning policies outlined in the London Borough of Hillingdon Local Plan.

ENERGY & SUSTAINABILITY SUMMARY

The reduction in regulated CO2 emissions for the overall development under each scheme is summarised to the right.

The energy strategy for Avondale Drive Estate achieves an overall 88% reduction in regulated CO2 emissions against the Part L compliant baseline.

In alignment with The London Plan and Hillingdon's Local Plan, the energy strategy has made the fullest contribution to minimising energy demand, maximising on-site carbon savings and making the fullest contribution to the efficient supply of energy through renewable technologies. The strategy has maximised all technically and economically viable energy efficiency measures, including:

- Enhanced building fabric performance (meeting or surpassing Part L standards)
- Low g-value glazing to reduce solar gains
- High-efficiency mechanical and electrical services
- Installation of circa 483No. of photovoltaic solar panels to support on-site electricity generation.

These measures collectively ensure that the development achieves the fullest possible contribution toward a low-carbon, energy-efficient refurbishment, while remaining compliant with National and Local Plan

Be Lean	30% reduction	An overall 30% reduction in regulated carbon emissions over the Part L 2021 Building Regulations Compliant Development.
Be Clean	0% reduction	No carbon emission reductions achieved at this stage.
Be Green	58% reduction	An overall 58% reduction in regulated carbon emissions over the Part L 2021 Building Regulations Compliant Development.

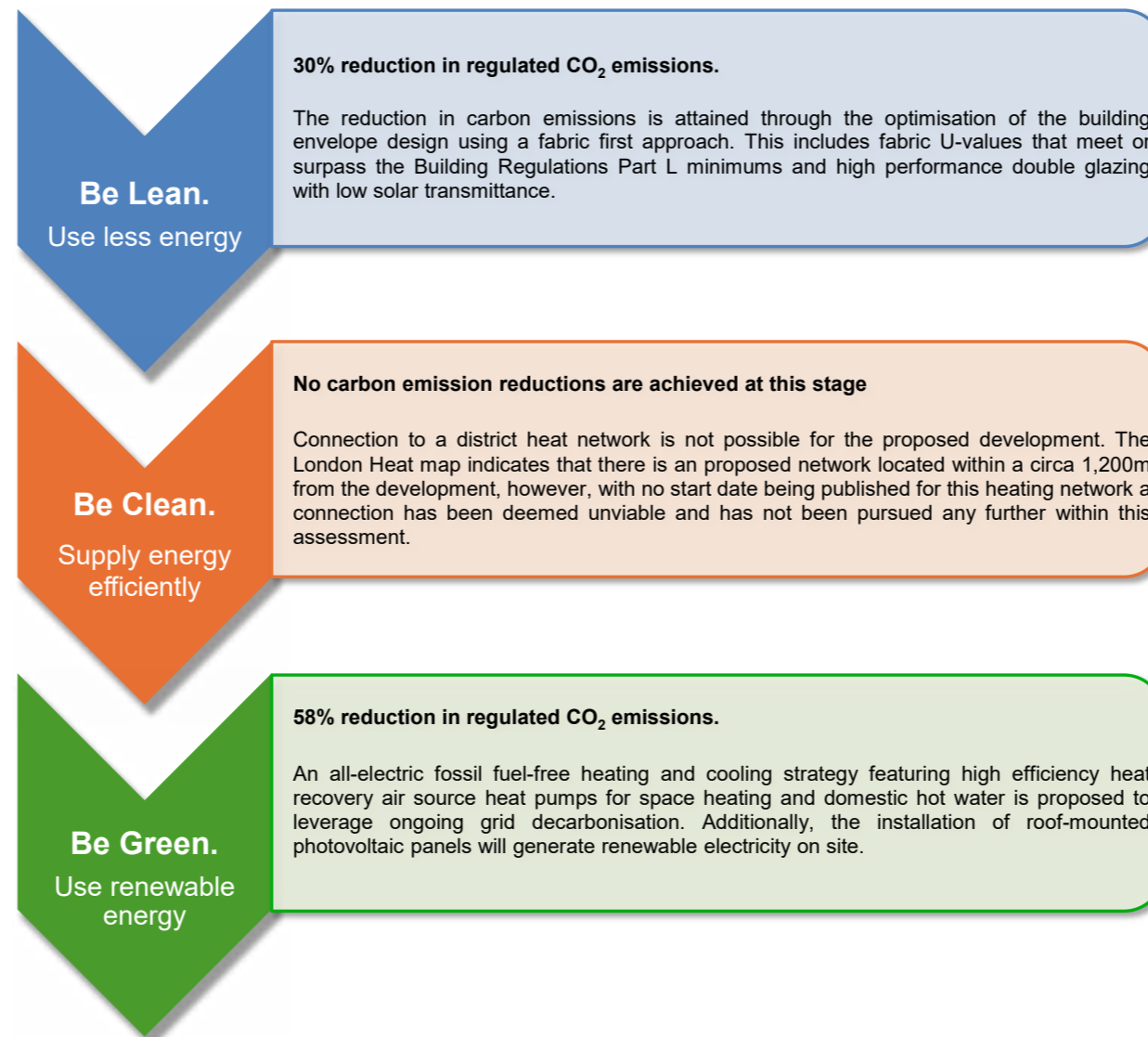

- A / 024
- A / 233-6
- M / 232

7.2 TRANSPORT STRATEGY

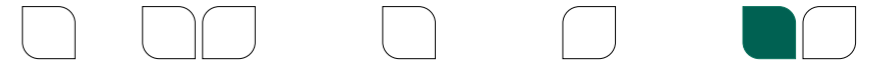

PEDESTRIAN ACCESS

The proposals maintain a 2.5m wide footway width along the Avondale Drive frontage, which continues along the frontage of Abbotswood Way. North of the Phase 2 parking access the proposals accommodate a 2m footway, which connects with the existing provision to the north along the Hitherbroom Park frontage. In this location it is acknowledged that there are proposed works outside of the redline boundary to deliver this continuous footway provision and soft landscaping. If required, a further full planning application will also be submitted to secure permission for these works falling between the redline and the adopted highway along Abbotswood Way.

A proposed 1.8m wide footpath wraps around the north of Phase 1B, providing ground floor access to duplex units on that northern frontage.

Direct pedestrian access to each of the proposed lobbies is taken from the footway.

The proposals include a pedestrian route between Phase 1B and Phase 2, which will provide public access to Hitherbroom Park to the north.

Vehicle crossovers will include raised entry treatments and tactile paving in order to support pedestrian movements.

CYCLE PARKING

Cycle parking will be provided in accordance with Planning Condition 15 and London Plan standards both in terms of quantum and type, within each block. The cycle parking is accommodated within either the undercroft parking areas or dedicated ground floor stores, which by default will ensure they are secure and sheltered. Access to the stores will be via the existing local highway network and then the sites internal access routes.

In addition to the residential provision, short-stay visitor provision will be provided, located within the public realm between phases, meeting the minimum policy requirement of 1 space per 40 units + 1 space (i.e. 8).

SERVICING

The development proposals include a series of bin stores, located along the site frontage within 10m of the existing kerbline, which will be accessed via kerbside collection, with drop-kerbs provided in front of these bin stores.

In order to ensure these bin stores are accessible to LBH refuse collection vehicles and not obstructed by parked vehicles, it will be necessary to introduce waiting controls in front of them, which

will also permit general loading activity associated with other delivery vehicles.

If necessary, a formalised loading bay can be introduced along the site frontage as part of the subsequent implementation of any Parking Management Scheme.

CAR PARKING

The development proposals include a total of 70 car parking spaces. Of this total 8 spaces are reserved for blue badge holders only, meeting the minimum London policy requirement of 3% of households having access to a blue badge parking space from the outset of occupation. The RMA is also supported by a Parking Management Plan, which identifies strategies for allocation and ongoing management as well as how the car parking provision can evolve to increase blue badge allocation in the future should demand dictate.

Phase 1B parking is accessed via a proposed 4.5m wide access with Abbotswood Way, above which there is a resident's courtyard at first floor podium level.

Phase 2 parking is accessed via a 4.5m wide proposed access with Avondale Drive, between Blocks B and C.

A number of initiatives are proposed to mitigate potential parking overspill concerns, namely:

- Secure and sheltered cycle parking where there is currently none provided;
- Provision of car club spaces;
- Travel Plan measures such as car share database;
- Structural changes such as increased cost of car ownership/ insurance; road space charging; increase in uptake of electric bikes/ scooters, which are likely to dampen car ownership levels in the future; and
- Contributions towards improved active mode infrastructure.

More importantly, in addition to these interventions, the S106 Agreement in relation to the approved development has also secured contributions towards the consultation and implementation of a potential Parking Management Scheme in order to mitigate the impacts of the development, along with an additional clause that would ensure residents of the development would not be able to apply for parking permits should a parking management scheme be necessary.

EMERGENCY ACCESS

The core associated with each of the proposed blocks is located within 18m of the existing Avondale Drive and Abbotswood Way

carriageway, allowing fire tender access from the existing kerbline.

Block E does however require a fire tender to access the southern extent of the pedestrianised route through to Hitherbroom Park in order to get within an acceptable distance of the associated core.

Access to this area will be facilitated by the introduction of a vehicle crossover in front of the pedestrianised route and a row of removable bollards that fire crews will be able to operate with a fire key, with these bollards otherwise ensuring the pedestrianised nature of this route on a day to day basis.

STOPPING UP / ADOPTION

Consistent with the original approval and the pending S73 proposals, the RMA proposals result in the indicative Phase 1B building footprint encroaching onto existing footpaths around the existing building perimeter that form part of the adopted public highway.

It will therefore be necessary to submit a stopping up allocation in accordance with Section 247 of the Town and County Planning Act, in good time prior to the delivery of Phase 1B.

The stopping up is mitigated via the delivery of an alternative footway around the proposed building footprint, with the section fronting the highway able to be offered for adoption.

HIGHWAY WORKS

The proposals will remove any redundant crossovers and reinstate as footway provision as necessary.

The proposals will introduce vehicle crossovers to serve the proposed car parks and emergency access between the phases.

These works will necessitate subsequent detailed designs and highway approvals to form part of a subsequent S278 Agreement



7.3 WASTE STRATEGY

SUMMARY STRATEGY

The development proposals are designed to be convenient for residents and collection operatives, as well as compliant with relevant standards. Overall, the proposed waste strategy has been integrated with the design to provide facilities that promote residential recycling and align with relevant environment objectives.

Internally, residents in all homes will use containers to promote the segregation of waste at source, including Dry Mixed Recycling (DMR) and food waste. Selected homes at ground level adjacent to the public highway will store waste in suitable receptacles within their frontage. Residents within the majority of homes will be provided with access to ground level communal waste stores to deposit their segregated waste within each block.

The communal waste stores are conveniently positioned close to building entrances and provide clearly labelled containers for residual waste, DMR and food waste, helping residents understand how to dispose of waste correctly and encouraging higher recycling rates. The stores are designed to be clean, well-lit, and easy to use for residents.

On collection days, the LBH Refuse Collection Vehicles (RCVs) will stop in safe and legal loading position on the kerb adjacent to each of the communal waste stores, allowing collection staff to access bins directly from the stores and return them once emptied.

For larger unwanted items (such as furniture), residents are provided with access to facilities for the storage of bulky waste for council collection, helping to prevent clutter and fly-tipping.



7.4 FIRE STRATEGY

SUMMARY

Introba has been engaged as a specialist fire and life safety consultant to develop and validate the Fire Strategy in support of a Hybrid Planning Application submitted to the Hillingdon Council by the Applicant, London Borough of Hillingdon. The Fire Strategy for the development has been designed in accordance with BS 9999:2024. Additionally, guidance from The London Plan has been introduced. Both pieces of guidance have been developed to ensure the highest standard of fire safety is designed into the building development at an early stage of design.

The development has been split into 2 phases; Phase 1B and Phase 2. Buildings B, C & D (11–18 m) will each have a single-stair residential core configured to satisfy BS 9991:2024 means of escape, lobby protection, fire-fighting facilities and smoke control principles for this height band. Buildings E & F (18–30 m) are provided with two independent stairs, configured to satisfy BS 9991:2024 escape, lobby protection. The travel distance and occupancy capacities have been designed in accordance with BS 9991:2024. Where travel distances are extended this will be justified via smoke control and CFD analysis at a later stage of development.

Each stair forms part of a protected route with associated smoke control and fire-fighting facilities. Each stair core will have an evacuation lift which is separated from the accommodation and stair by a lift lobby, to satisfy the recommendations of both BS 9991:2024 and the London Plan, the evacuation lifts will be designed and installed in accordance with EN 81-72.



7.5 STRUCTURAL STRATEGY



THE SITE

Hesi completed the site investigation for the Phase 1 site in November 2022. The site investigation noted that Made Ground was encountered across the site at variable depths of between 0.00m and 0.50m below ground level. The Made Ground is above the Langley Silt Member with a depth range of 1.10m to 1.40m below ground level. The Langley Silt Member is above Lynch Hill Gravel with a depth up to 6.50m below ground level. The Lynch Hill Gravel is above London Clay. No groundwater was encountered up to 30m below ground level. The site investigation notes that the sulphate class for the concrete in contact with the ground should be Class DS-1 / AC-1. A new geotechnical site investigation will need to be carried out for the Phase 1B and Phase 2 sites; however, similar ground conditions are expected.

STRUCTURAL DESIGN PRINCIPLES

Both blocks will be constructed using reinforced concrete frames, Phase 1B - 10 storeys and Phase 2 - 6 storeys. The structure will be supported on pad foundations at least 1300mm deep, where the allowable bearing capacity of the ground is 250kN/m². RC columns and walls will be supported on the pad foundations, with the ground floor suspended slabs also supported by the pad foundations.

The superstructure for all blocks will comprise of RC frames with 225mm deep reinforced concrete flat slabs at typical upper floors and a column grid in the region of 6m. Rectangular or blade columns (typically 800mm x 225mm) will be utilised within the construction in order that they are concealed within party walls and partially within external walls. In order to provide lateral stability to the buildings, to resist wind loads or notional horizontal forces, it is necessary to provide reinforced concrete shear walls (250mm thick) to transfer the loads into the foundations.

KEY ELEMENTS

The transfer beams, transfer slabs and all columns below them will be designed as key elements.

DISPROPORTIONATE COLLAPSE CLASSIFICATION

The structure includes up to 10 storeys of residential accommodation, giving the buildings a class of 2b in accordance with table 11 of Part A of the approved documents. Classification 2b requires effective horizontal and vertical ties for all floors, walls and columns.

PERFORMANCE CRITERIA

All elements of structure will be designed for a life of 60 years. Unless specified otherwise, tolerances will (where applicable) be within the limits given in BS EN 13670-2009.

MATERIALS

Unless noted on the drawings otherwise all concrete will be grade C32/40 and all steelwork will be grade S355.

DEMOLITION

All three blocks are constructed as reinforced concrete frames. There are no elements or design principles that should be unusual for a competent contractor.

STANDARDS AND REFERENCES

All designs are to be carried out in accordance with the appropriate Eurocodes, Codes of Practice and the Building Regulations.

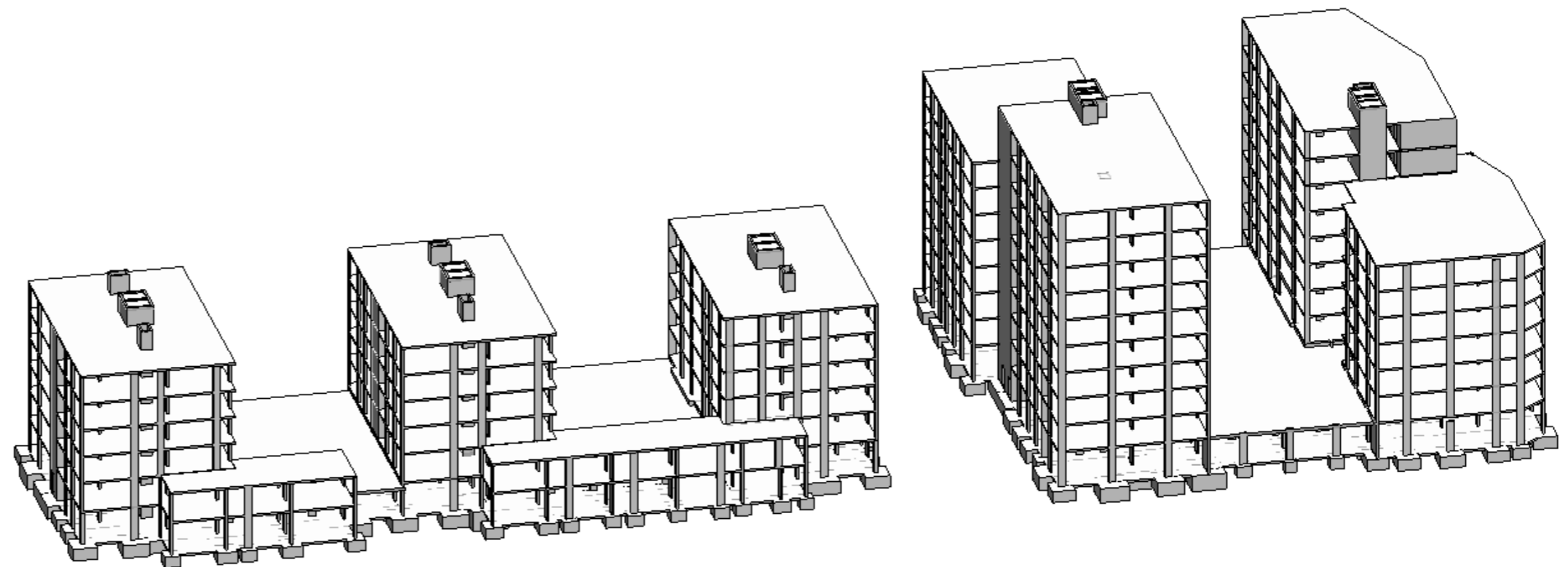

PROPOSED INDICATIVE STRUCTURAL FRAME

7.6 DRAINAGE STRATEGY



DRAINAGE STRATEGY

The proposed drainage strategy for the Avondale Drive development follows the design principles set out in the previously approved drainage strategy prepared by Whitby Wood in 2021 and submitted as part of the S73 application.



SURFACE WATER DRAINAGE

Surface water will be managed through a gravity drainage system incorporating shallow attenuation tanks located beneath the proposed car park and landscaped areas. These tanks will control runoff before discharging at two locations: one connection to the Phase 1 drainage system, limited to a discharge rate of 1.0 l/s, and a second connection to the public Thames Water surface water sewer in Avondale Drive, limited to 2.3 l/s. This dual-discharge arrangement provides controlled runoff in accordance with sustainable drainage requirements.

Proposed impermeable highway areas will connect to the existing highway drainage network and will be designed in detail as part of the S278 works.

Rain gardens are proposed across the site, each with an underlying perforated pipe to manage overflow. Green roofs at first-floor level are also included. The current drainage strategy incorporates these green roofs within impermeable catchment calculations, providing flexibility to reduce attenuation volumes during the detailed design stage if required.

FOUL WATER DRAINAGE

Foul water will be conveyed via a gravity drainage network with two proposed connections to the existing public Thames Water foul sewer in Avondale Drive. An existing foul sewer located adjacent to the southeast corner of the building footprint will require local diversion to accommodate the new development layout. Following diversion, this sewer will provide an additional foul discharge connection point. The diversion will be subject to both a build-over agreement and a diversion agreement with Thames Water.

All new on-site drainage infrastructure will remain private and will be managed and maintained by the development's management company. The diverted foul sewer will be adopted and maintained by Thames Water, subject to their approval. All proposed connection points and discharge rates will be confirmed with Thames Water as part of the application process.

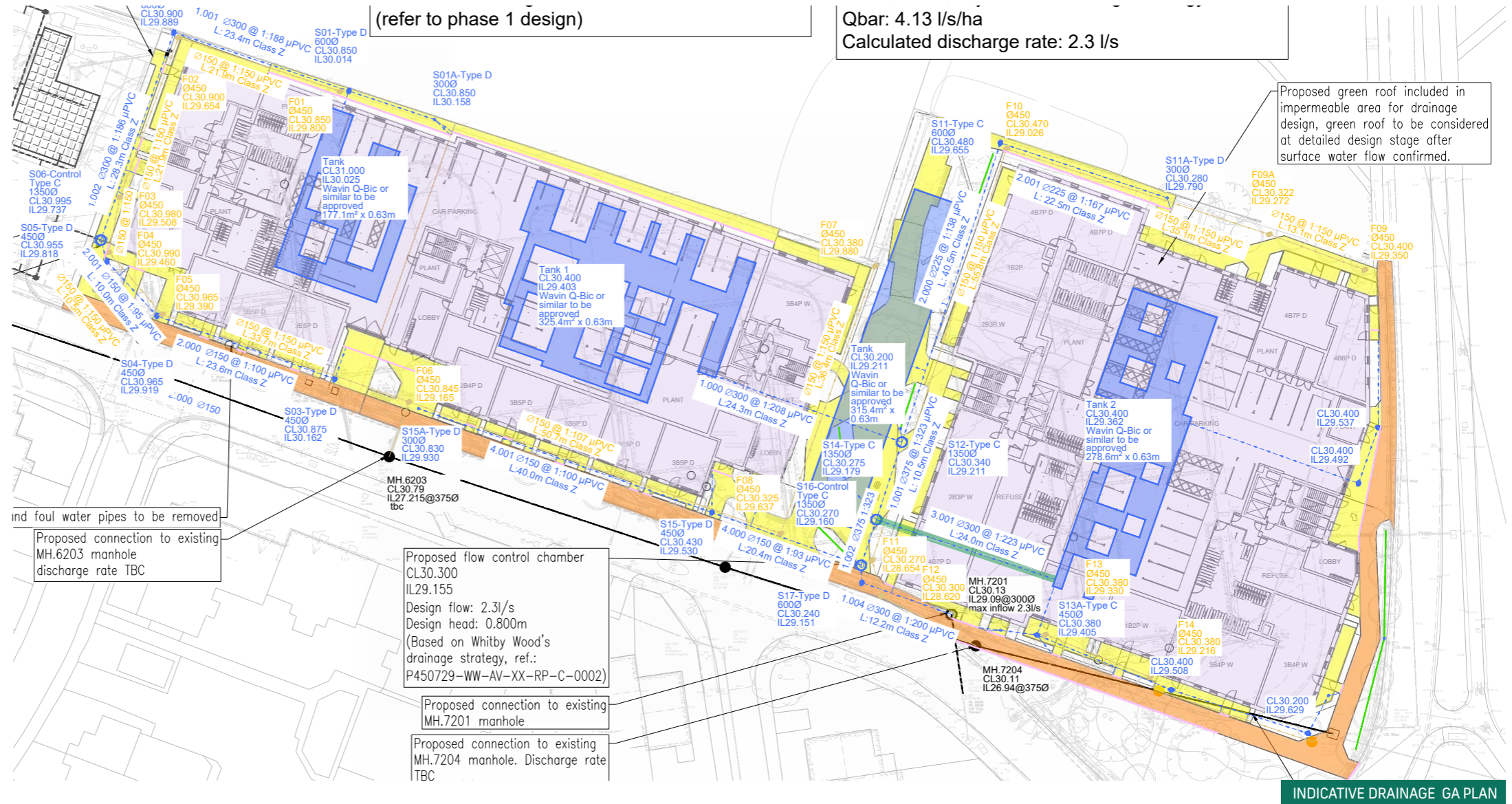

7.7 ACCESS, CLEANING AND MAINTENANCE

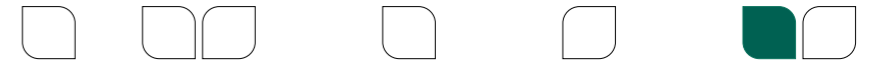

PLANT ACCESS

Most of the ground floor plant rooms have level access into them, accessed either directly from the street or internally via the car parks in each phase. There is a small, single step down into the phase 2 commercial sprinkler tank room, and the phase 1B tank is located underground, below the car park with access hatches in the communal cycle stores.

ROOF ACCESS

In each phase, the tallest block with roof level plant rooms, blocks C and E, will have access via permanent stairs with a pop-up enclosure to the roof level, providing safe and easy access for maintenance and equipment replacement purposes only. This will be secured to prevent access to residents. Any major plant replacement could also be done by crane from ground level.

The top roofs of blocks B, D and F, without dedicated plant rooms, will allow access via a 'coffin' hatch with permanent stairs leading up to this. These allow for easy access for maintenance and replacement of smaller parts. These hatches will also be secured to prevent access to residents.

The lower roofs of blocks E and F are accessed from doors out of the taller parts of the block. This accessed will be stepped, but will be limited to maintenance only with some kind of access control to prevent use by residents.

Access to the green roofs atop of the phase 2 duplexes will be via ladder from the level 1 podium in the areas indicated. This ladder will either be non-permanent or fixed with a drop down that prevents ordinary use by residents.

PARAPETS

All parapets are a minimum of 1100mm high for safe use by residents and/or maintenance workers.

The access and maintenance strategy will be developed further at the next design stage.



PV panels on brown roofs



'Coffin' roof hatch access with stair up to hatch

Key

- Roof parapet - 1100mm min
- Podium parapet - 1100mm min
- Full stair access with pop-up to roof level allowing safe and easy access to plant rooms and to roof, for maintenance only
- 'Coffin' roof hatch with full stair up to hatch for safe and easy access to roofs with limited plant equipment, access for maintenance only
- ▲ Access to green roofs via ladder (one storey height change from podium), for maintenance only
- ▲ Access to lower roofs via door at lower level with stepped access, for maintenance only

ROOF PLAN ACCESS AND CDM CONSIDERATIONS

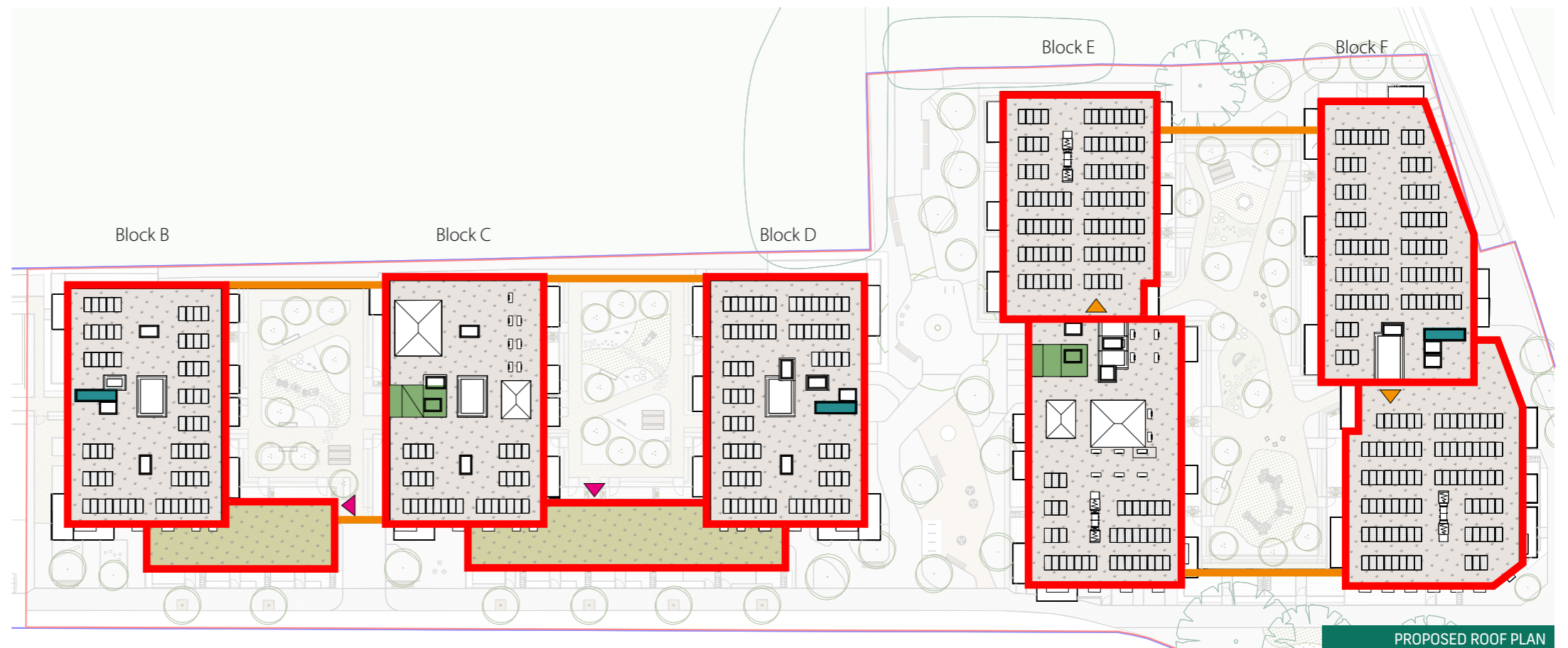

PROPOSED ROOF PLAN

7.8 WINDOW CLEANING STRATEGY



SITE WIDE STRATEGY

Window cleaning strategies were developed early in the detailed design process.

For easily accessible windows, the following methods are adopted:

- Windows within balconies are externally accessible from the balcony.
- Ground floor windows can be cleaned externally from ground level.
- First-floor windows facing the podium are externally cleaned from the podium terrace.



Pole Cleaning

To mitigate overheating, and for all other windows – specifically those on the north and south elevations, in duplexes, and facing the Phase 1B podium courtyard – full-height, inward-opening windows with Juliet balconies are proposed. These windows are designed for internal cleaning.

PHASE 2

Phase 2's mid-rise buildings are all six storeys. Their east and west elevation windows will be externally cleaned using long poles, a strategy consistent with Phase 1A.

PHASE 1B

For Block E's west elevation in Phase 1B, windows up to six storeys will be externally cleaned via long poles. Windows above the sixth storey will utilize "self-cleaning glass" to limit maintenance.

Key

- █ Window to be cleaned internally - Juliet balcony
- █ Window to be cleaned externally by poles (same as phase 1A) - upto 6 storey
- █ "Self-cleaning glass" applied for window over 6 storey.

WINDOW CLEANING STRATEGY DIAGRAM

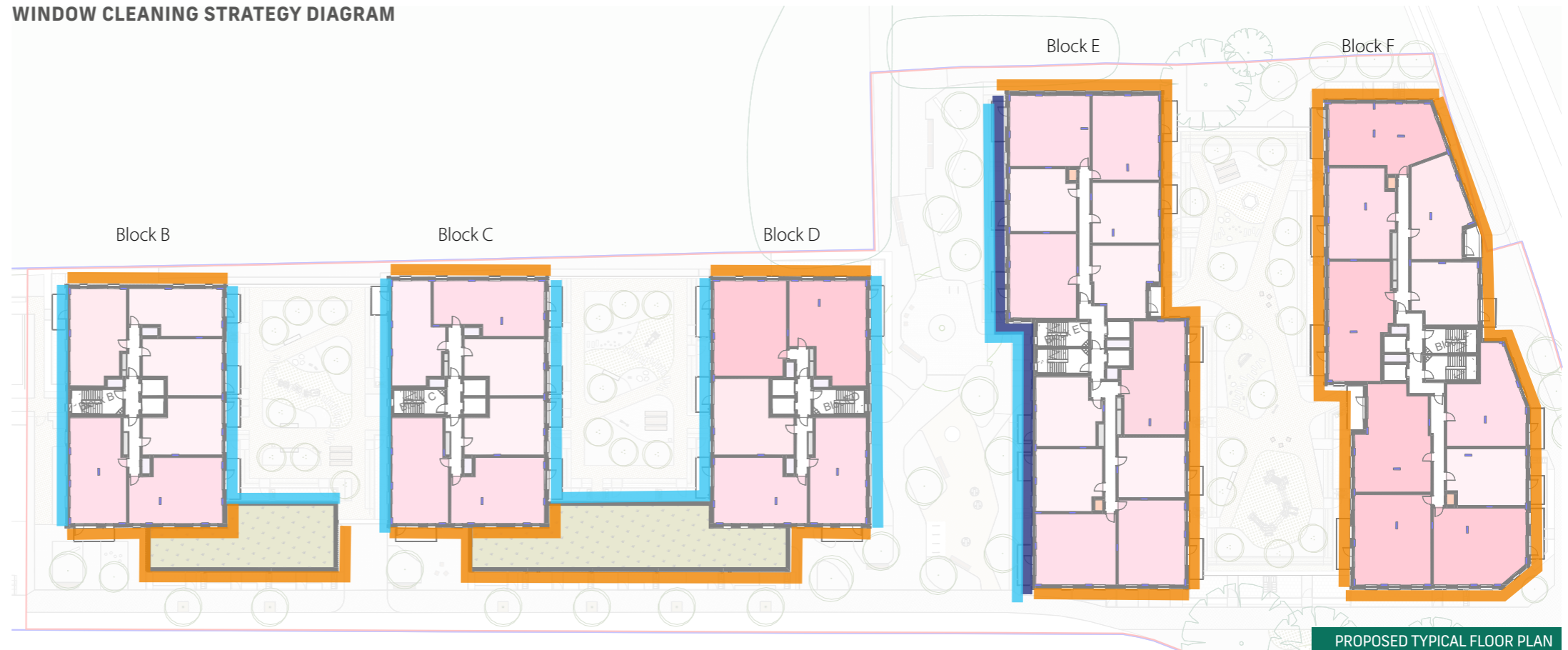

7.9 DAYLIGHT SUNLIGHT STRATEGY

SUMMARY STRATEGY

The updated daylight and sunlight assessment reviews the revised Avondale Drive proposals against the S73 scheme. The assessment examines impacts on neighbouring properties, internal daylight and sunlight performance within the proposed accommodation, sunlight availability to new amenity spaces, and overshadowing effects on Hitherbroom Park, in accordance with the 2022 BRE guidance.

When compared with the S73 scheme, changes in internal daylight and sunlight performance, including Vertical-Sky-Component, No-Sky Line (NSL) and Annual Probable Sunlight Hours (APSH), are generally limited. The majority of assessed rooms demonstrate negligible change, with any localised reductions remaining modest and within the range anticipated for a high-density town centre location.

Internal daylight levels across the proposed residential accommodation remain consistent with BRE guidance and relevant residential quality standards. The layouts have been carefully developed to optimise access to daylight and sunlight, with primary living spaces positioned closest to windows, appropriate room depths, and window arrangements designed to maximise sky visibility. These design measures ensure that good levels of daylight are achieved where they are most beneficial to residents, supporting a high-quality internal environment.

The sunlight assessment confirms that adequate levels of sunlight are maintained to the proposed accommodation, with the majority of dual-aspect and south-facing units achieving good APSH performance. Any shortfalls are limited and reflect the urban context and constraints of the site.

The overshadowing analysis demonstrates that Hitherbroom Park continues to achieve the BRE target of a minimum of two hours of sunlight on 21 March, with no material reduction in sunlight compared to the S73 scheme. Overall, the revised massing and layout strategy delivers an appropriate daylight and sunlight environment that responds to site constraints while remaining aligned with planning policy and design standards.

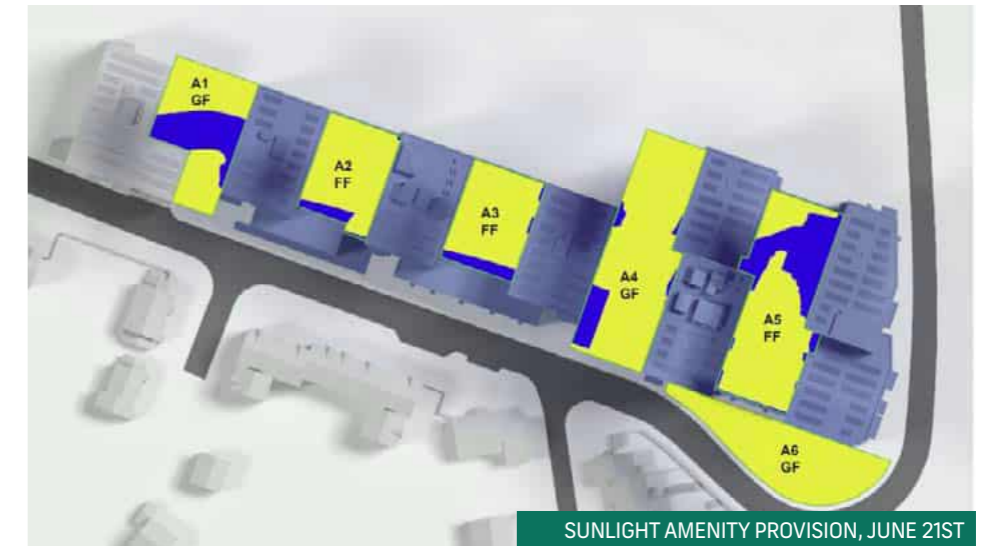
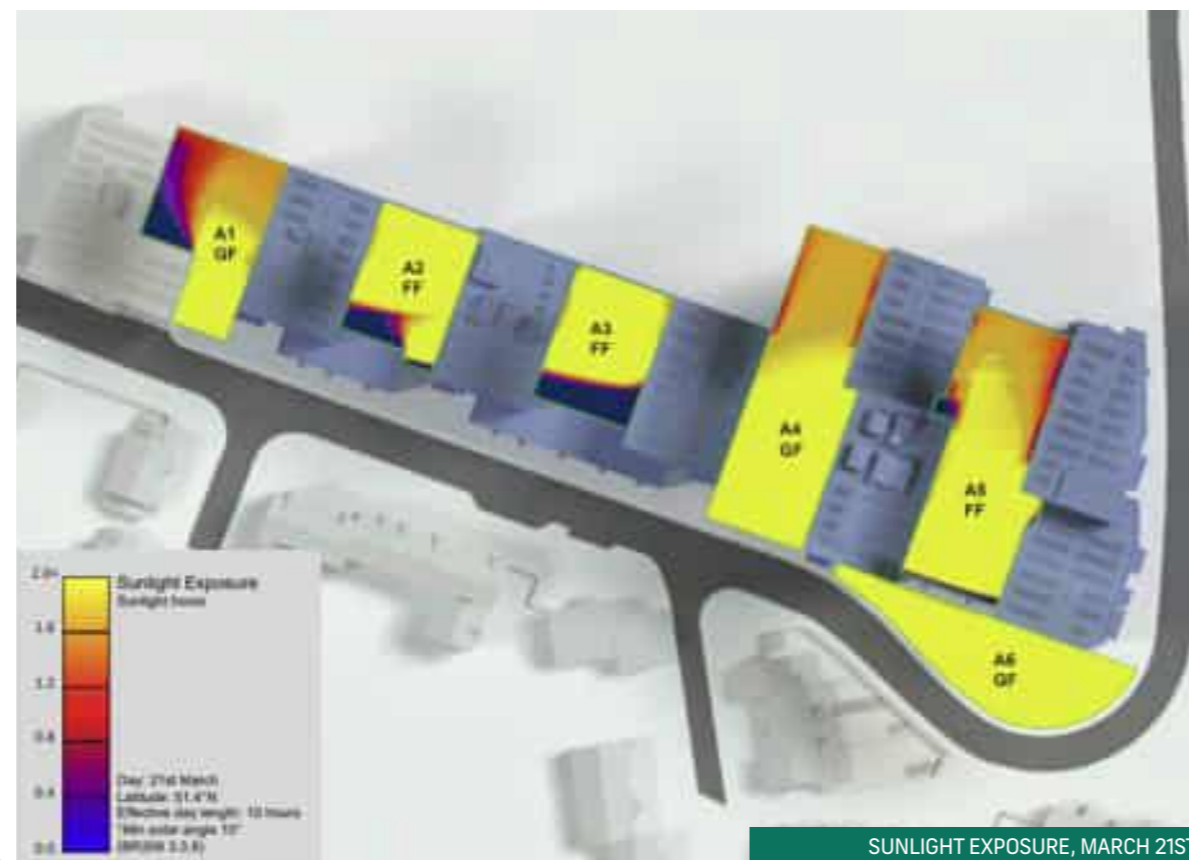
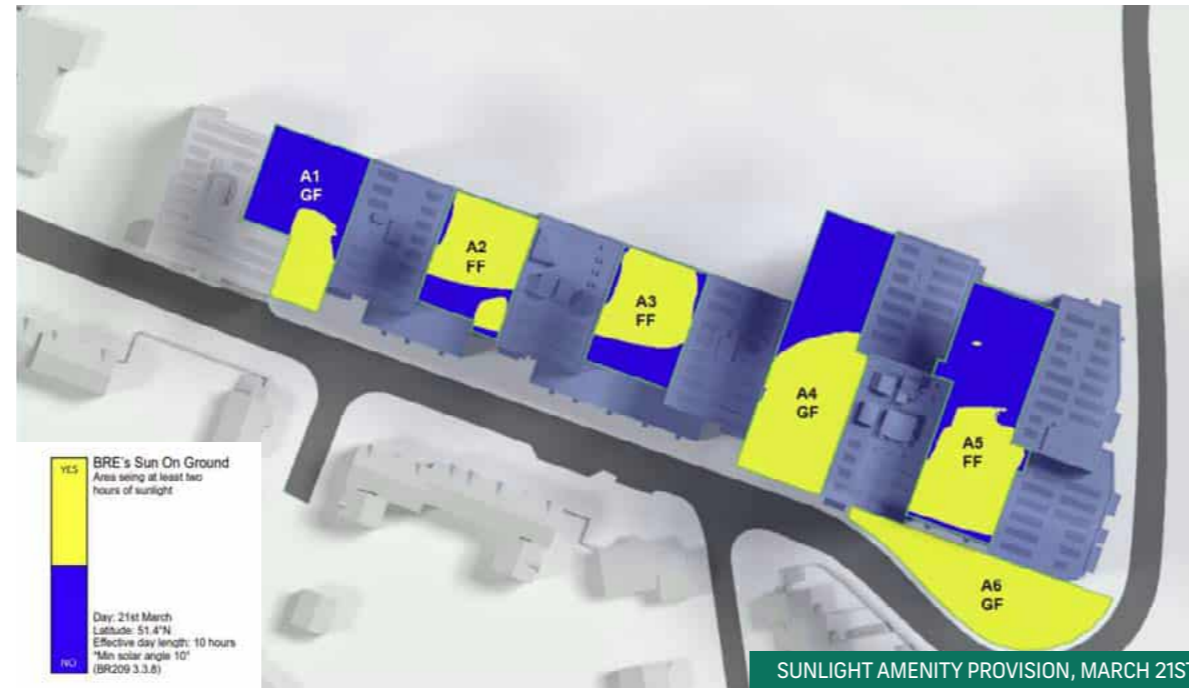

- A / 162
- A / 231
- M / 004
- M / 028
- M / 057
- M / 125
- M / 131
- M / 226-28

7.10 OVERHEATING STRATEGY

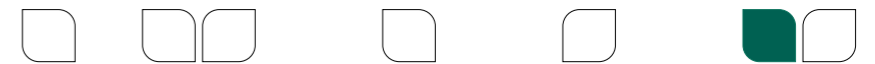

OVERVIEW

This overheating risk assessment has been prepared by Watkins Payne on behalf of the London Borough of Hillingdon ('LBH') in support of a reserved matters application for Land at Avondale Drive, pursuant to Condition 1 of the hybrid permission for the site. A Section 73 application (application ref: 76551/APP/2025/2861) is currently pending and will be determined prior to the approval of this Reserved Matters Application. Therefore, this RMA responds to the revised wording of the planning conditions proposed within the Section 73 application.

The purpose of this assessment is to evaluate the potential risk of overheating within the proposed development (Phases 1b and 2) and to demonstrate compliance with Approved Document Part O (2021) and CIBSE TM59 (2017). The overheating mitigation strategy has been developed in accordance with the London Plan (2021) Policy SI 4 Managing Heat Risk, adopting a passive first approach that prioritises design measures which minimise reliance on mechanical cooling while supporting occupant comfort.

An iterative modelling and design process has been undertaken to guide the development towards compliance with policy and regulatory requirements. Sequential simulations were carried out to test and refine passive design measures and, where necessary, to incorporate targeted mechanical interventions to ensure acceptable thermal comfort conditions. This structured methodology ensures that all phases of the development accord with the overarching objective of delivering a high quality, climate resilient residential development, consistent with both local and regional planning policy expectations.

METHODOLOGY

Dynamic thermal simulation modelling has been undertaken using EDSL TAS (version 9.5.7) for a representative sample of apartment and duplex units across Phases 1b and 2 (Blocks B to F) covering 54% of the total proposed dwellings. The sample selection encompasses all typologies and orientations across multiple floor levels, including those located in the most heat sensitive areas. All communal areas, including internal corridors, staircores and entrance lobbies, were also assessed to evaluate performance against CIBSE TM59 overheating criteria.

The assessment has been carried out using the DSY1 (2020s high emissions, 50th percentile) weather file for London Heathrow, in accordance with the requirements of Part O and TM59, with additional testing under DSY2 (short duration heatwave) and DSY3 (prolonged warm summer) conditions to assess future climate resilience.

COOLING HIERARCHY

The proposed overheating mitigation strategy has been developed in full accordance with the London Plan cooling hierarchy, prioritising passive design measures before the introduction of low energy mechanical ventilation and, where necessary, beneficial cooling to ensure compliance.

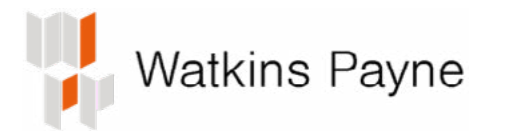

Measure	Implementation
1. Reduce the amount of heat entering the building	
External fabric	Highly insulated external walls and roofs to minimise heat gain through conduction.
Solar control glazing	All windows to achieve a solar transmittance (g-value) of 0.40 or lower.
External shade from balconies, brise soleil window reveals	Incorporation of recessed windows on all facades, balconies and horizontal brise soleil where appropriate.
2. Minimise internal heat generation through energy efficient design	
LED lighting	High efficiency LED lighting installed throughout to reduce internal heat gains.
Pipework insulation	Well insulated hot water pipework to reduce heat loss from the centralised distribution network.

Energy efficiency equipment	Energy efficient equipment with low heat output.
3. Manage heat within the building through exposed thermal mass and high ceilings	
Medium thermal mass	Moderate thermal mass (190 kJ/m ² K) for buffering effect.
4. Provide passive ventilation	
Natural ventilation via openable windows, patio doors and AOVs	All habitable spaces benefit from fully openable windows and/or balcony doors to enable natural ventilation, openable to at least 90° for enhanced air flow.
5. Provide mechanical ventilation	
MVHR with boost mode	All habitable spaces will have MVHR units with in-built summer bypass function, providing continuous background ventilation. In addition, a boost mode capable of delivering up to 2ACH will be available to provide enhanced ventilation.
5. Provide cooling	
MVHR cooling coil	Beneficial cooling from MVHR cooling coil is provided where acoustic constraints limit the feasibility of natural ventilation.

A / 039 A / 230

M / 028 M / 057 M / 227 M / 229

OVERHEATING STRATEGY

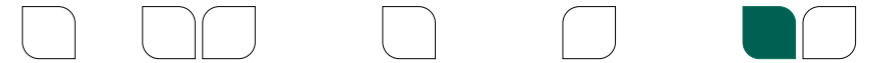

SUMMARY OF RESULTS

RESIDENTIAL UNITS

Across Phases 1b and 2, the overheating assessment demonstrates a clear progression in performance through the application of the London Plan cooling hierarchy. Under the baseline natural ventilation scenario, 81% of sampled residential units achieve full compliance with TM59, increasing to 93% with targeted MVHR boost ventilation. With the proposed MVHR cooling coil strategy in place, full compliance is achieved across all sampled units. These results confirm that the proposed design delivers an effective and policy-compliant approach to managing overheating risk across the development.

Noise measurements have been taken on site to establish dominant sources such as traffic noise, construction noise, and overhead aircraft. The roadways at the boundaries of the site have recorded levels which are considered as too high for openable windows during night-time for overheating purposes as set out in the new Part O. Therefore, whilst windows have been designed to be openable to aid window cleaning & rapid ventilation into apartments. The summertime overheating strategy is based on a mechanical MVHR ventilation solution (coiling coil installed in supply duct), reducing / eliminating the need to open windows to overcome summertime overheating.

The internal ambient noise level is important for comfort and therefore careful selection of plant and attenuators will also be required.

COMMUNAL CORRIDORS, STAIRCORES AND ENTRANCE LOBBIES

The assessment confirms that the proposed design for Phases 1b and 2 achieves full compliance with TM59 criterion 1 for non-residential communal areas under natural ventilation. Targeted design refinements, including reductions in glazing ratios to entrance lobby areas, additional external shading from overhanging balconies and improved natural ventilation provision through AOVs, have demonstrably reduced peak operative temperatures. The assessment indicates that all communal spaces maintain acceptable thermal conditions during the DSY1 design summer year.

THERMAL MASS

A high thermal mass will help reduce the risk of overheating.

To prevent the risk of overheating within the flats and communal areas the flats have been designed with openable windows to provide purge ventilation rate during periods of warm weather albeit with the extra noise. The operable windows enable occupants to achieve thermal comfort via passive means however due to the noise levels the occupants can also achieve this via keeping the windows closed and using the beneficial cooling provided via the MVHR coil. The design of the glazing and the brise soleil in the façade helps minimise the amount of solar gain getting in through the building fabric. Internal gains from waste heat have been minimised through low running temperatures for the heating and hot water systems and internal District Heating risers located within the flats.

All circulation spaces within the block will be installed with natural ventilation (via AOV) to minimise overheating.

RENEWABLES / LOW CARBON DESIGN

The Avondale Drive Estate development shall meet the London Plan requirements using a combination of Heat Pumps, thermal storage and PV panels.

The energy strategy that was submitted for planning was developed in-line with the Mayors' Energy Hierarchy of "Be Lean, Be Clean, Be Green and Be Seen". The key principles of the energy are set out below: -

- 1) Installation of a mixture of Air Heat Pumps and Water Source heat pumps to be used for heating, cooling and domestic hot water production
- 2) PV panels to be installed on the roof.

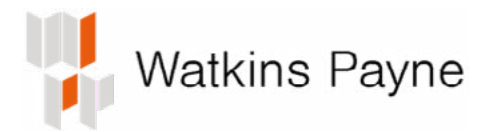

TM59 Compliance Summary DSY1 – Development							
	Block					Development	
	B	C	D	E	F		
Baseline	14/19	17/18	15/17	49/52	21/38	116/144	81%
Targeted MVHR Boost	18/19	17/18	16/17	50/52	33/38	134/144	93%
Beneficial Cooling	19/19	18/18	17/17	52/52	38/38	144/144	100%

M / 028

M / 057

M / 227

M / 229

A / 039

A / 230

7.11 WIND TESTING

SUMMARY STRATEGY

The wind environment CFD study has been undertaken by WINDTECH Consultants to assess the wind microclimate around the proposed Avondale Drive Estate development in London. The key findings from the Wind Environment CFD report are:

- The wind conditions at the ground are safe and suitable for the intended use.
- The wind conditions at the elevated levels are safe and suitable for the intended use in most areas. However, there is an outdoor seating area on Phase 2 where the wind conditions are unsuitable for the intended use.

For the seating area where the wind conditions are unsuitable for the intended use, it was recommended that further mitigation measures be implemented such as the hard and soft landscaping. This has been incorporated into the final RMA design.

For further detail refer to the wind environment report (Ref: WH590-03F02 (rev1) - CFD WE Report).

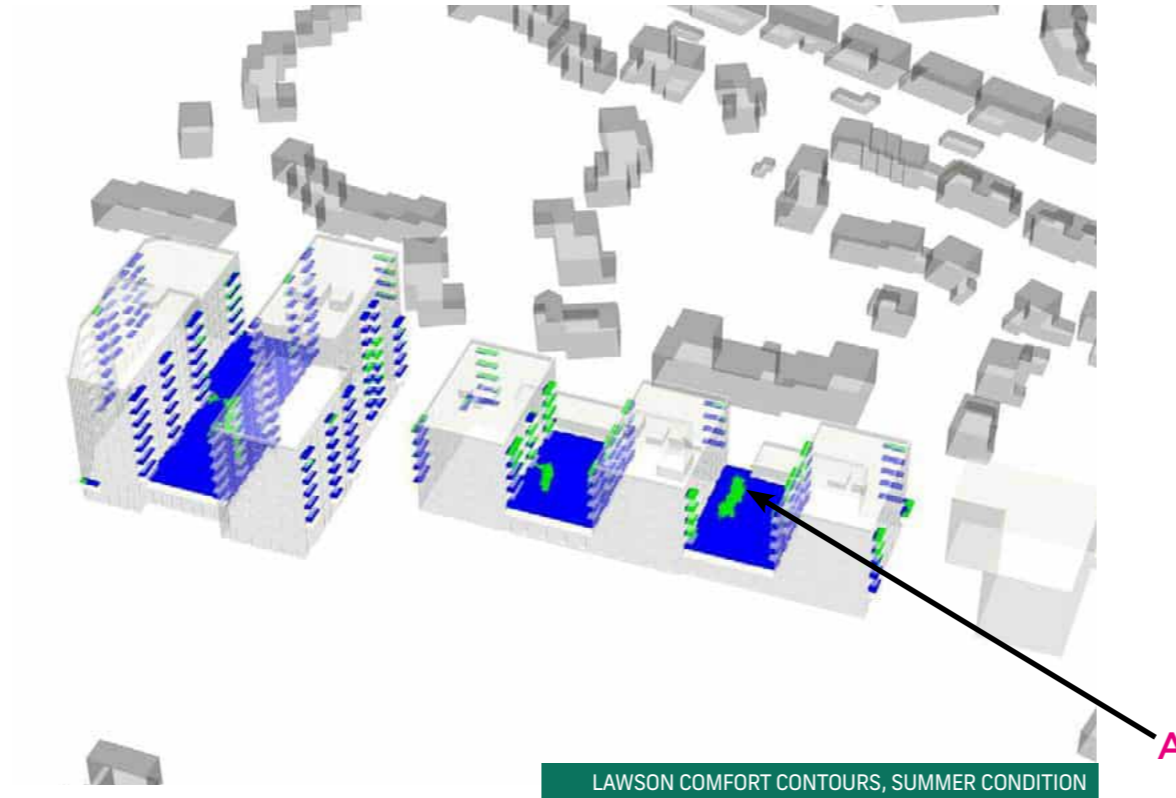

LAWSON COMFORT CONTOURS, SUMMER CONDITION

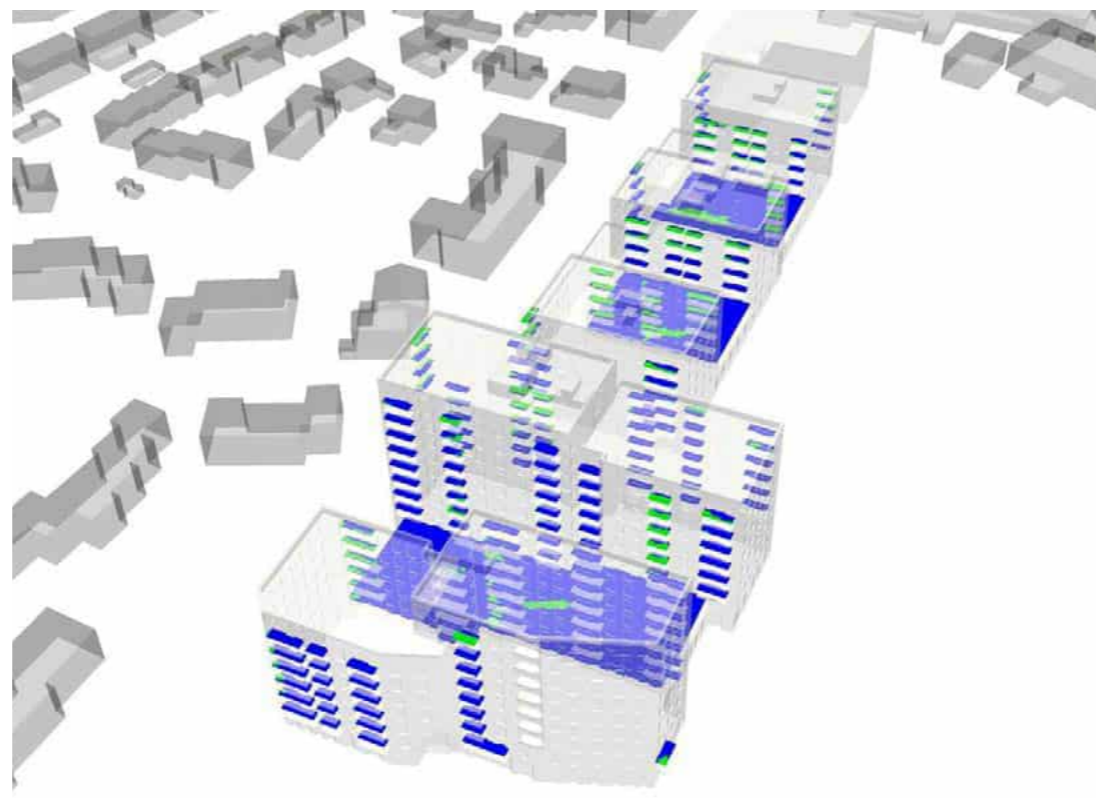

LAWSON COMFORT CONTOURS, SUMMER CONDITION

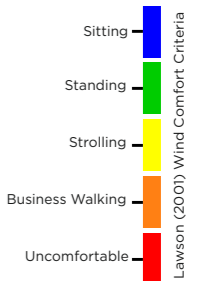
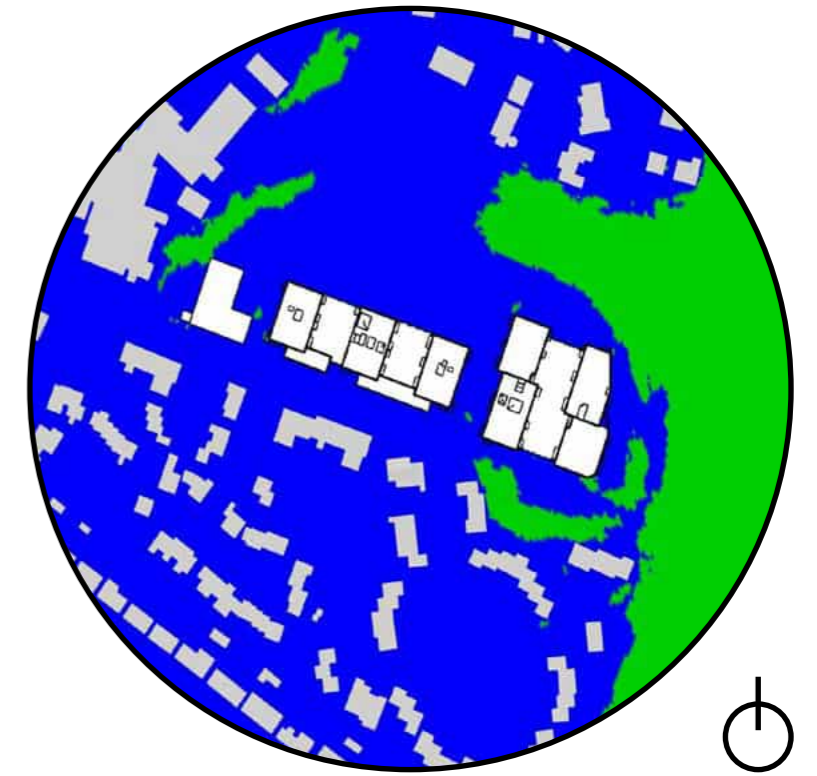
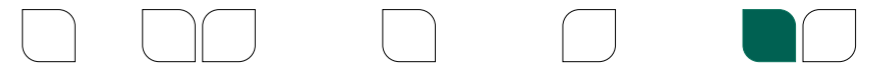

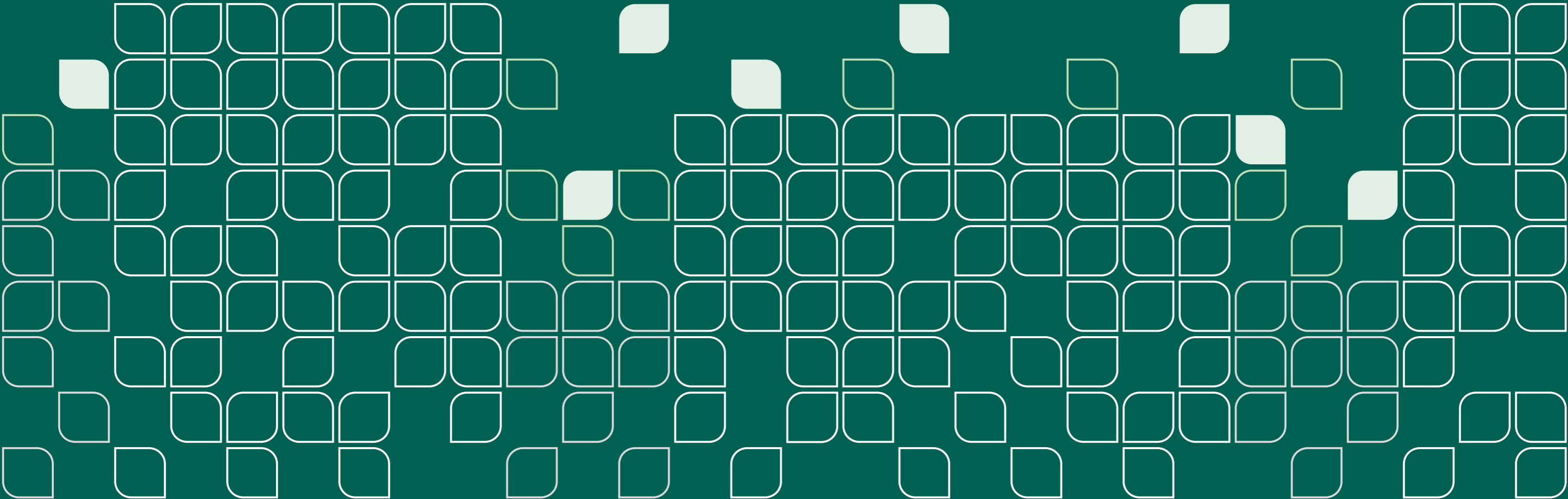

8. APPENDIX

8.1 APPENDIX 1 - DETAILED AREA SCHEDULE

8.1.1 Phase 2

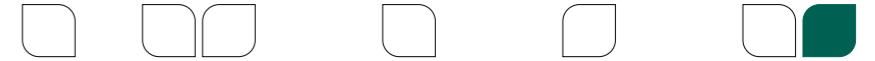

Note: The tenure mix and distribution shown on this schedule is indicative only and will be controlled separately through the s106 agreement

Phase 2

Block B - Social Rent															
	1B2P 50m ²	1B2P W 58m ²	2B3P 63m ²	2B3P W 75m ²	2B4P 70m ²	2B4P W 82m ²	2B4P D 80m ²	3B5P 86m ²	3B4P W 95m ²	3B5P D 96m ²	4B6P D 106m ²	4B7P D 115m ²	Total	NIA (m2)	GIA(m2)
0				1			1			2			4	347	626
1	1	1	2					1					5	320	578
2	3		1		2								6	353	450
3	3		1		2								6	353	450
4	3		1		2								6	353	450
5	3		1		2								6	353	450
Total	13	1	6	1	8	0	1	1	0	2	0	0	33	2,079	3,005

Block C - Social Rent															
	1B2P 50m ²	1B2P W 58m ²	2B3P 63m ²	2B3P W 75m ²	2B4P 70m ²	2B4P W 82m ²	2B4P D 80m ²	3B5P 86m ²	3B4P W 95m ²	3B5P D 96m ²	4B6P D 106m ²	4B7P D 115m ²	Total	NIA (m2)	GIA(m2)
0							1			2			3	272	342
1		2	1	1	1								5	324	594
2	2	1			3								6	368	466
3	2	1			3								6	368	466
4	2	1			3								6	368	466
5	2	1			3								6	368	466
Total	8	6	1	1	13	0	1	0	0	2	0	0	32	2,068	2,799

Block D - Social Rent															
	1B2P 50m ²	1B2P W 58m ²	2B3P 63m ²	2B3P W 75m ²	2B4P 70m ²	2B4P W 82m ²	2B4P D 80m ²	3B5P 86m ²	3B4P W 95m ²	3B5P D 96m ²	4B6P D 106m ²	4B7P D 115m ²	Total	NIA (m2)	GIA(m2)
0									1	2			3	287	501
1	2	1						2					5	330	550
2			1		2			2					5	375	466
3			1		2			2					5	375	466
4			1		2			2					5	375	466
5			1		2			2					5	375	466
Total	2	1	4	0	8	0	0	10	1	2	0	0	28	2,117	2,914

Parking GIA(m2)
1,207

Roof Plant GIA(m2)
58

APPENDIX 1 - DETAILED AREA SCHEDULE

8.1.2 Phase 1B



Note: The tenure mix and distribution shown on this schedule is indicative only and will be controlled separately through the s106 agreement

Phase 1B Block by Block

Block E - Private															
	1B2P 50m ²	1B2P W 58m ²	2B3P 63m ²	2B3P W 72m ²	2B4P 70m ²	2B4P W 82m ²	2B4P D 80m ²	3B5P 86m ²	3B4P W 95m ²	3B5P D 96m ²	4B6P D 106m ²	4B7P D 115m ²	Total	NIA (m2)	GIA(m2)
0													0	0	Combined with Block F
1	5			2	2								9	534	
2	6				5	1							12	732	
3	6				5	1							12	732	
4	6				5	1							12	732	
5	6				5	1							12	732	
6	6				5	1							12	732	
7	6				5	1							12	732	
8	3				2	1							6	372	
9	3				2	1							6	372	
Total	47	0	0	2	36	8	0	0	0	0	0	0	93	5,670	

Phase 1B - Social Rent															
	1B2P 50m ²	1B2P W 58m ²	2B3P 63m ²	2B3P W 75m ²	2B4P 70m ²	2B4P W 82m ²	2B4P D 80m ²	3B5P 86m ²	3B4P W 95m ²	3B5P D 96m ²	4B6P D 106m ²	4B7P D 115m ²	Total	NIA (m2)	GIA(m2)
0	1	2		2					2		1	4	12	1,072	Combined with Block F
Total	1	2	0	2	0	0	0	0	2	0	1	4	12	1072	

Block F - Private															
	1B2P 50m ²	1B2P W 58m ²	2B3P 63m ²	2B3P W 72m ²	2B4P 70m ²	2B4P W 82m ²	2B4P D 80m ²	3B5P 86m ²	3B4P W 95m ²	3B5P D 96m ²	4B6P D 106m ²	4B7P D 115m ²	Total	NIA (m2)	GIA(m2)
0													0	0	
1	1												1	50	
2	2		1		1								4	233	
3	2		1		2			3					8	561	
4	2		1		2			5					10	733	
5	2		1		2			5					10	733	
6	2		1		2			5					10	733	
7	1		1		1			2					5	355	
8	1		1		1			2					5	355	
Total	13	0	7	0	11	0	0	22	0	0	0	0	53	3,753	12,534

Block F - Social Rent															
	1B2P 50m ²	1B2P W 58m ²	2B3P 63m ²	2B3P W 75m ²	2B4P 70m ²	2B4P W 82m ²	2B4P D 80m ²	3B5P 86m ²	3B4P W 95m ²	3B5P D 96m ²	4B6P D 106m ²	4B7P D 115m ²	Total	NIA (m2)	GIA(m2)
0													0	0	
1			1	1	1			4					7	552	
2					1			5					6	500	
3								2					2	172	
4													0	0	
5													0	0	
6													0	0	
7													0	0	
8													0	0	
Total	0	0	1	1	2	0	0	11	0	0	0	0	15	1,224	3,110

Parking GIA(m2)
951

Roof Plant GIA(m2)
57

APPENDIX 1 - DETAILED AREA SCHEDULE

8.1.3 Summary

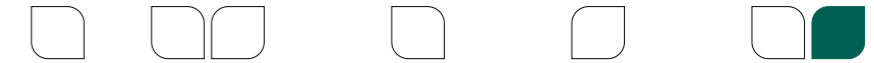

Note: The tenure mix and distribution shown on this schedule is indicative only and will be controlled separately through the s106 agreement

Phase 1B & Phase 2 Summary

Phase 1B + 2 - Social Rent															
	1B2P 50m ²	1B2P W 58m ²	2B3P 63m ²	2B3P W 75m ²	2B4P 70m ²	2B4P W 82m ²	2B4P D 80m ²	3B5P 86m ²	3B4P W 95m ²	3B5P D 96m ²	4B6P D 106m ²	4B7P D 115m ²	Total	NIA (m2)	GIA(m2)
Total	24	10	12	5	31	0	2	22	3	6	1	4	120	8,560	11,826
Mix	28%		42%				26%			4%		100%			

Phase 1B + 2 - Private															
	1B2P 50m ²	1B2P W 58m ²	2B3P 63m ²	2B3P W 72m ²	2B4P 70m ²	2B4P W 82m ²	2B4P D 80m ²	3B5P 86m ²	3B4P W 95m ²	3B5P D 96m ²	4B6P D 106m ²	4B7P D 115m ²	Total	NIA (m2)	GIA(m2)
Total	60	0	7	2	47	8	0	22	0	0	0	0	146	9,423	12,534
Mix	41%		44%				15%			0%		100%			

Phase 1B + 2 Total																	
	1B2P	1B2P W	2B3P	2B3P W	2B4P	2B4P W	2B4P D	3B5P	3B4P W	3B5P D	4B6P D	4B7P D	Total	NIA (m2)	GIA(m2)	Parking GIA(m2)	Roof Plant GIA(m2)
Total	84	10	19	7	78	8	2	44	3	6	1	4	266	17,983	24,361	2,158	114
Mix	35%		43%				20%			2%		100%					

8.2 APPENDIX 2 - MANDATORY CODE COMPLIANCE SCHEDULE

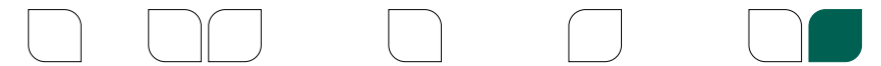

APPROACH TO DESIGN CODE

The Avondale Drive Design Code, submitted as part of the recent Section 73 application and to be secured via a revised wording of Planning Condition 8, establishes a clear and comprehensive design framework for the proposed development. This framework comprises both mandatory and advisory provisions.

Evidence of full compliance with all mandatory codes cross-referenced to the relevant details within the main body of this Design and Access Statement (DAS) are scheduled in this appendix.

ADVISORY CODE

In contrast, the advisory elements of the Design Code embody a commitment to design excellence and contemporary best practice, acting as a guiding framework rather than a rigid set of regulations. Our approach to these qualitative recommendations is founded on the following key principles:

- 1. Qualitative, Not Quantifiable:** The advisory codes are inherently qualitative and aspirational, rather than measurable by strict metrics. As such, demonstrating definitive quantitative 'compliance' is neither straightforward nor appropriate. Instead, our focus has been on interpreting and responding thoughtfully to the underlying intent and spirit of these provisions, ensuring they meaningfully enhance the overall design quality.
- 2. Best Practice, Not Regulation:** These advisory codes represent current best practice in urban design and placemaking. They provide valuable guidance aimed at delivering high-quality, sustainable outcomes rather than prescriptive statutory requirements. Accordingly, they function as informing principles that elevate design decisions without constraining innovation or context-specific responses.
- 3. Integral Design Consideration:** Throughout the detailed design process for this Reserved Matters Application (RMA), the advisory codes have been fully embedded within our design approach. From early masterplanning through to detailed architectural and landscape proposals, these principles have been central to our iterative process, shaping key elements such as layout, massing, materials, and the public realm.
- 4. Application Where Possible:** We have applied the advisory principles wherever technically feasible, economically viable, and appropriate to the specific site context and planning policy. This pragmatic approach acknowledges that while advisory codes set ambitious benchmarks, their realisation must be balanced with site constraints, regulatory frameworks, and practical delivery considerations.

MANDATORY CODE COMPLIANCE SCHEDULE - KEY

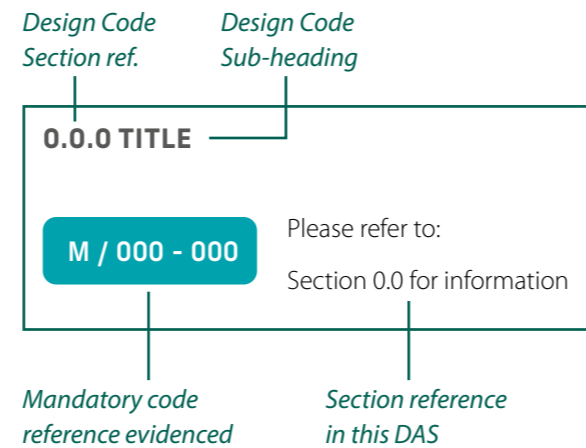

Please note this appendix lists compliance for mandatory codes only. Advisory codes are excluded, and therefore code references listed here may not appear exhaustive.

2.2.1 MASSING & TOWNSCAPE

M / 001 - 011

- Please refer to:
- Section 4.2 for development extents
 - Section 4.3 for general massing, storey heights and floor to floor heights
 - Section 6.4 for how the massing defines and responds to character areas
 - Section 6.7 for marker building and key corner architectural expression and detailing
 - Section 7.9 for daylight/sunlight requirement influences on the massing
 - Section 7.10 for overheating requirement influences on the massing

2.2.2 BUILDING HEIGHTS

M / 013 - 016

- Please refer to:
- Section 4.3 for general massing, storey heights and evidence of compliance with the Building Heights Parameter Plan

2.2.3 ROOFSCAPES

M / 017 - 023

- Please refer to:
- Section 4.3 for general massing, storey heights and evidence of compliance with the Building Heights Parameter Plan
 - Sections 4.16 & 4.17 for detailed proposed roof plans of each phase including design and set out of all plant / equipment.
 - Section 5.3 for information on the green / brown roof strategy

2.2.4 BALCONIES

M / 025 - 029

- Please refer to:
- Section 4.2 for the extents of the proposed development
 - Sections 4.7, 4.10, 4.13 and 4.14 for detailed first floor and typical floor plans showing the location of all balconies
 - Section 4.20 for the overall balcony strategy including general sizing principles and justifications for locations including privacy/overlooking considerations
 - Section 6.6 for balcony drainage strategy and general design including tenure-blind principles
 - Section 7.10 for overheating requirement influences on the balconies
 - Section 7.11 for Wind testing and design mitigations employed to ensure thermal comfort

2.2.5 ACTIVE FRONTAGES

M / 030 - 034

- Please refer to:
- Sections 4.6 and 4.9 for the detailed ground floor plan of each phase.
 - Sections 4.8 and 4.11 outlining the active frontages strategy and all access strategies for each phase.
 - Section 4.20 for the overall amenity and defensible space strategy

APPENDIX 2 - MANDATORY CODE COMPLIANCE SCHEDULE

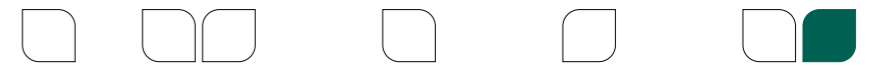

2.2.6 FRONTAGES AND ELEVATIONS

M / 036 - 048

Please refer to:

Sections 4.8 and 4.11 outlining the active frontages strategy and all access strategies for each phase.

Section 6.4 for key elevations and how these define and respond to character areas

Section 6.6 for elevational detail elements and strategies for minimising their visual impact

Section 6.9 for detailed site wide elevations

2.2.7 ENTRANCES

M / 049 - 052

Please refer to:

Sections 4.6 and 4.9 for the detailed ground floor plan of each phase.

Section 4.12 for Secured by Design considerations

Section 6.6 for balcony drainage strategy

Section 6.7 for architectural details including some entrances

Section 6.8 for entrance bay studies

2.2.8 WINDOWS

M / 057

Please refer to:

Section 6.5 for fenestration strategy

Section 7.9 for daylight/sunlight requirements

Section 7.10 for overheating requirements

2.2.9 PRIVACY

M / 060 - 061

Please refer to:

Section 4.15 for daylight, privacy and overlooking strategy

Section 4.20 for details on defensible space provisions

2.2.10 MATERIALITY AND APPEARANCE

M / 063 - 066

Please refer to:

Section 6.1 for existing context analysis

Section 6.2 for the primary architectural elevational concept, including tonal strategy

Section 6.3 for the proposed materials and colour palette

Sections 6.9 and 6.10 for the proposed materiality in site elevations / final CGIs

2.2.11 RESIDENTIAL QUALITY

M / 072 - 081

Please refer to:

Section 4.3 confirming minimum floor to ceiling heights in dwellings

Sections 4.13 and 4.14 for typical floor plans confirming compliance with NDSS

Section 4.18 showing typical dwelling layouts across a range of sizes

Section 6.5 for the fenestration strategy

Sections 4.8, 4.11 and 7.4 for the overall fire strategies including escape from dwellings and layout considerations

2.3 ACCESSIBILITY

M / 090 - 095

Please refer to:

Section 4.12 for the site wide levels strategy

Section 4.19 for the inclusive design strategy and principles

2.4.1 PARKING

M / 103 - 107

Please refer to:

Sections 4.8 and 4.11 outlining the car parking access and provision strategies

2.4.2 ACCESS

M / 109

Please refer to:

Section 6.8 showing the phase 1b proposed access gate in bay study context

Section 6.9 showing the phase 2 proposed access gate in site elevational context

2.4.3 CYCLE STORE

M / 111 - 115

Please refer to:

Sections 4.8 and 4.11 for the cycle parking provision strategy

Section 5.2 for short stay provisions in landscape

2.4.4 REFUSE

M / 116 - 118

Please refer to:

Sections 4.8 and 4.11 for the refuse strategy

2.5.1 PUBLIC REALM AND OPEN SPACES

M / 122 - 127

Please refer to:

Sections 4.8 and 4.11 for the active frontages strategy, including overlooking the public realm

Section 5.1 for the landscape masterplan and play strategies

Section 5.2 for the public realm design

Section 7.9 for the daylight / sunlight assessments on the proposed public realm

APPENDIX 2 - MANDATORY CODE COMPLIANCE SCHEDULE

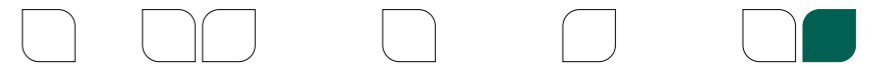

2.5.2 STREETScape

M / 130 - 140

Please refer to:
 Section 4.3 for the proposed massing and townscape strategy summary
 Section 5.2 for the public realm design
 Section 7.9 for the daylight / sunlight assessments on the proposed public realm
 Section 4.12 for the site wide levels strategy

2.5.3 PRIVATE AMENITY AND DEFENSIBLE SPACE

M / 142 - 152

Please refer to:
 Section 4.2 for the proposed development extents
 Sections 4.6 and 4.9 for the detailed proposed ground floor plans per phase
 Sections 4.7 and 4.10 for detailed first floor podium plans per phase
 Section 4.20 for the amenity and defensible space strategy
 Section 5.2 for the interface of amenity and defensible space provisions with the public realm design
 Section 5.4 for the proposed landscape materiality
 Sections 6.9 and 6.10 for the indicative appearance of amenity and defensible spaces in context

2.5.4 COMMUNAL COURTYARDS

M / 156 - 161

Please refer to:
 Sections 4.7 and 4.10 for detailed first floor podium plans per phase
 Section 4.15 for the general daylight, privacy and overlooking strategy
 Section 4.20 for the amenity and defensible space strategy
 Section 5.2 for the communal courtyards landscape design
 Section 7.9 for the daylight/sunlight strategy

2.5.5 PLAY, FITNESS AND RECREATION

M / 171 - 172

Please refer to:
 Section 5.1 for the landscape play strategy
 Section 5.2 for the public realm design

2.5.6 MATERIALS AND STREET FURNITURE

M / 178 - 180

Please refer to:
 Section 5.2 for the public realm design
 Section 5.4 for the landscape materiality strategy

2.5.7 TREES AND PLANTING

M / 193 - 196

Please refer to:
 Section 4.2 for extents of development showing set back from existing trees as approved at Outline
 Section 5.3 for the landscape planting strategy
 Section 7.6 for drainage strategy details

2.5.8/9 BIODIVERSITY AND ECOLOGY

M / 207 - 211

Please refer to:
 Section 5.3 for the landscape planting strategy

2.5.10 URBAN GREENING FACTOR

M / 214

Please refer to:
 Section 5.3 for the landscape planting strategy

2.5.12 SAFE AND SECURE ENVIRONMENT

M / 219 - 222

Please refer to:
 Sections 4.6 and 4.9 for the detailed ground floor plan of each phase.
 Section 4.12 for Secured by Design considerations and site wide levels strategy
 Section 5.1 for the landscape play strategy

2.6.1 DAYLIGHT, SUNLIGHT AND OVERHEATING

M / 226 - 229

Please refer to:
 Sections 4.6 and 4.9 for the detailed ground floor plan of each phase.
 Section 4.15 for the general daylight, privacy and overlooking strategy
 Section 7.9 for a summary of the daylight/sunlight assessments and key principles
 Section 7.10 for a summary of the overheating strategy and key principles

2.6.2 ENERGY

M / 232

Please refer to:
 Section 4.2 for the general extents of development, showing the proposed footprint and relatively compact building form
 Section 7.1 for a general summary of the energy and sustainability strategy

APPENDIX 2 - MANDATORY CODE COMPLIANCE SCHEDULE

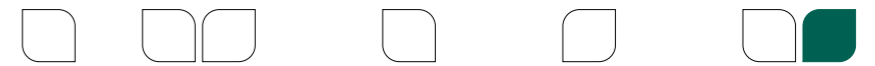

3.2 AVONDALE DRIVE CHARACTER AREA

M / 237 - 253

Please refer to:

Section 4.3 for the proposed massing

Sections 4.8 and 4.11 for the various supporting ground floor strategies in this area, including active frontage strategy

Section 4.18 for detailed dwelling layouts of the duplexes that characterise this zone

Section 4.20 for the amenity and defensible space strategy

Section 5.1 for the landscape and play strategies across the site and how these vary in character areas

Section 5.2 for the proposed public realm design and how this varies in character areas

Section 5.3 for the planting strategy

Section 6.4 for the designation of all character areas and the specific details and characteristics of this character area

Section 6.7 for architectural detailing of the marker building

Sections 6.8, 6.9 and 6.10 for imagery detailing the specific proposed architectural characters across the site

3.4 HITHERBROOM LINK CHARACTER AREA

M / 265 - 283

Please refer to:

Section 4.3 for the proposed massing

Sections 4.8 and 4.11 for the various supporting ground floor strategies in this area, including active frontage strategy

Section 4.20 for the amenity and defensible space strategy

Section 5.1 for the landscape and play strategies across the site and how these vary in character areas

Section 5.2 for the proposed public realm design and how this varies in character areas

Section 5.3 for the planting strategy

Section 6.4 for the designation of all character areas and the specific details and characteristics of this character area

Section 6.7 for architectural detailing of the marker building

Sections 6.8, 6.9 and 6.10 for imagery detailing the specific proposed architectural characters across the site

3.6 COURTYARD CHARACTER AREA

M / 295 - 302

Please refer to:

Section 4.3 for the proposed massing

Sections 4.7 and 4.10 for the detailed first floor plans of each phase

Section 4.20 for the amenity and defensible space strategy

Section 5.1 for the landscape and play strategies across the site and how these vary in character areas

Section 5.2 for the proposed public realm design and how this varies in character areas

Section 5.3 for the planting strategy

Section 6.4 for the designation of all character areas and the specific details and characteristics of this character area

Sections 6.8, 6.9 and 6.10 for imagery detailing the specific proposed architectural characters across the site

3.3 ABBOTSWOOD WAY CHARACTER AREA

M / 254 - 264

Please refer to:

Section 4.3 for the proposed massing

Section 4.9 for the detailed ground floor plan of this character area

Section 4.20 for the amenity and defensible space strategy

Section 5.1 for the landscape and play strategies across the site and how these vary in character areas

Section 5.2 for the proposed public realm design and how this varies in character areas

Section 5.3 for the planting strategy

Section 6.4 for the designation of all character areas and the specific details and characteristics of this character area

Section 6.7 for architectural detailing of all key corners

Sections 6.8, 6.9 and 6.10 for imagery detailing the specific proposed architectural characters across the site

3.5 PARK EDGE CHARACTER AREA

M / 284 - 294

Please refer to:

Section 4.3 for the proposed massing

Section 4.9 for the detailed ground floor plan of this character area

Section 4.11 for the various supporting ground floor strategies in this area, including active frontage strategy

Section 4.20 for the amenity and defensible space strategy

Section 5.1 for the landscape and play strategies across the site and how these vary in character areas

Section 5.2 for the proposed public realm design and how this varies in character areas

Section 5.3 for the planting strategy

Section 6.4 for the designation of all character areas and the specific details and characteristics of this character area

Section 6.7 for architectural detailing of all key corners

Sections 6.8, 6.9 and 6.10 for imagery detailing the specific proposed architectural characters across the site

